

Made to last.

ALBERTS®

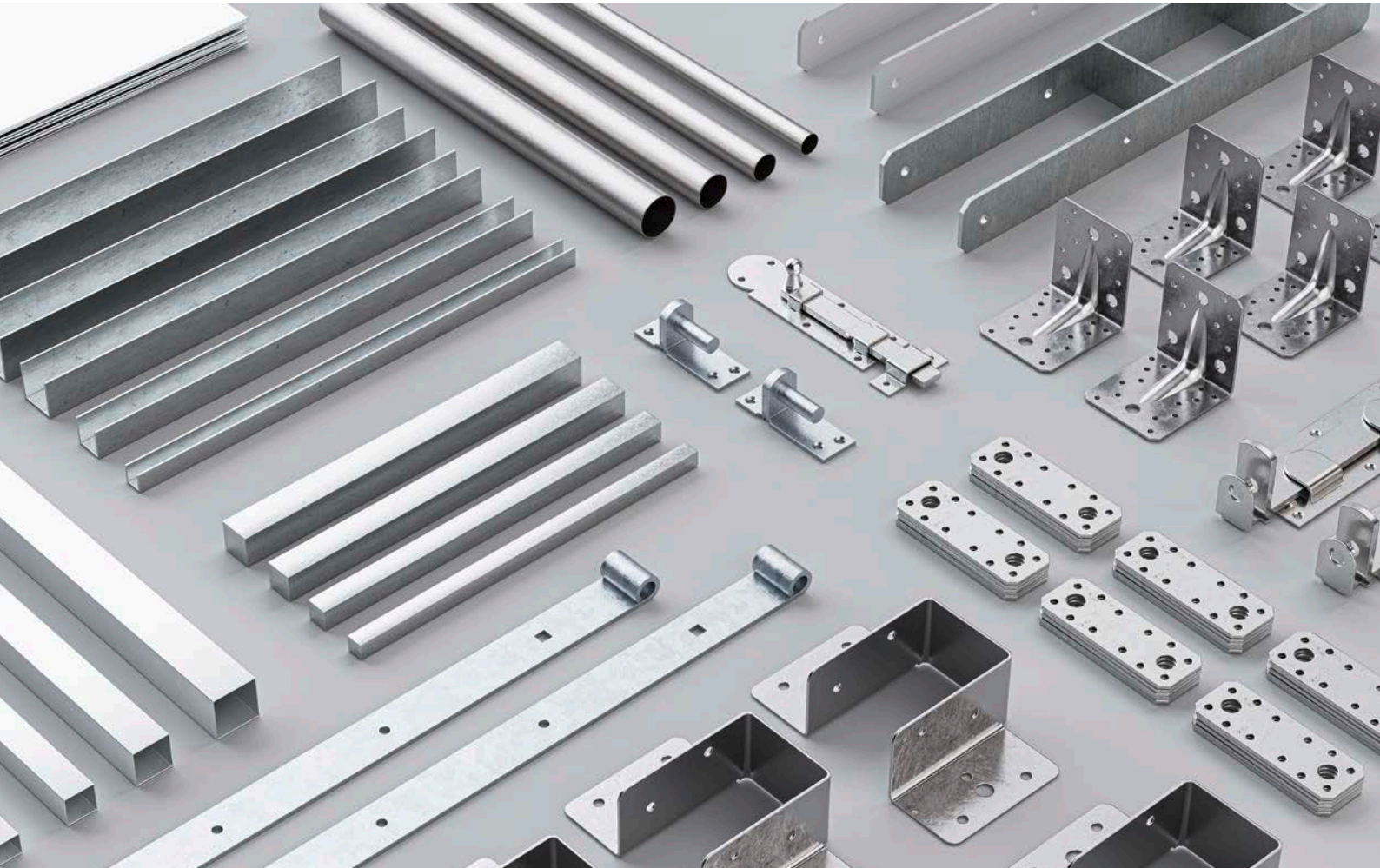

HARDWARE PROFILES AND SHEETS

alberts.de/en

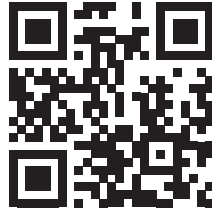

You want to know more?

Visit us on
alberts.de/en

ALBERTS®

170 years ago, there was no Eifel tower in Paris and no Statue of Liberty in New York. But our bolt forge in Herscheid already existed. In 1852, Gustav Alberts began manufacturing high quality hardware, and just as 170 years ago, Alberts products today, are **made to last**. Since then our range has grown to more than 7000 items: posts that hold fast, fences that stand firm, fittings that endure, our profiles that don't deform and our connectors that hold together. Our customers have been able to rely on this for 170 years. Today, the great-great-grandson of our founder is steering the fortunes at Alberts, relying on 500 employees in Germany, Europe and around the world. We are proud that our 8000+ trade partners trust us day after day, year after year. We would be overjoyed should you join us going into the future.

Send your order to:
orders@alberts.de

LEGEND

10 **10 year guarantee**
Guarantee conditions at alberts.de

15 **15 year guarantee**
Guarantee conditions at alberts.de

20 **20 year guarantee**
Guarantee conditions at alberts.de

CE
European Technical Approval

Equal leaf
Equal-sized double gate

Unequal leaf
Double gates with unequal leaves

Made in Germany
These articles are produced in Germany

ALU **Products made of aluminium**
These items are manufactured of aluminium

VA **Products made of stainless steel**
These products are manufactured of stainless steel

V4A **Products made of stainless steel**
These products are manufactured of stainless steel and are salt water-resistant

GP **Bargain pack**
Individual products were combined as a unit for retail and professional use. Depending on the article, packaged in boxes, in labelled cardboard boxes or shrink-wrapped in film.

Retail packaged items
Retail packaged items for shelf presentation

PU Price unit

UNIT Unit

L Goods available from stock

S No stock goods

LIST OF CONTENTS

DURAVIS®

DURAVIS® 7

Ovado

Ovado 19

Bolts

Bolts 27

Flush bolt for windows and doors 40

Wood connectors

Wood connectors 41

Nails and bar dowels 59

Angle brackets and mending plates

Angle brackets, mending plates 60

Builders and mounting band 73

Hinges

Hinges 74

Box fittings

Box fittings 81

Box hinges 82

Box fittings 84

Hasps 87

Hinges, shutter hinges and hooks

Hinges, shutter hinges and hooks 91

Tee and strap hinges 92

Shutter and gate hinges, hooks 96

Wooden gate fittings 113

Hinges, shutter hinges and hooks

Wooden fence fittings 130

Door fittings 139

Swing fittings 142

Post supports and ground sleeves for driving in

Post supports 146

Ground sleeves for driving in and screwing in 163

Caps for wooden posts

Caps for wooden posts 166

Window shutter fittings

Window shutter fittings 169

Screws and accessories

Screws and accessories 181

Metal gate and metal construction fittings

Metal gate fittings 185

Metal structure fittings 204

Handrail supports 205

Universal metal posts 206

Wrought iron

Wrought iron balusters 209

Decorative elements 213

Handrails 216

Window grilles

Wrought iron window grilles 218

Window grille accessories 224

Extending grilles 226

Grating securing devices 228

Profile board claws and accessories

Profile board claws and accessories 229

Wall connectors

Wall connectors 232

Metal sheets and accessories

Metal sheets 238

Accessories for metal sheets 249

DIY profiles

Aluminium profiles 250

Aluminium profiles, anodised 259

Aluminium profiles, decorative surfaces 269

Aluminium profiles, chrome design 270

Aluminium profiles, brushed 272

Aluminium profiles, shot blasted 275

Connector clamp profiles 277

Steel profiles 281

Conceptor® profile system 287

Stainless steel profiles 289

Brass profiles 292

Plastic profiles 295

Profiles, self-adhesive 304

Assembly accessories for profiles 308

Threaded bars 313

Flooring profiles

Carpet and laminate profiles 315

Step edge profiles 320

Accessories 323

Carpet and laminate profiles, shrink-wrapped 324

Stair edge profiles, wrapped in film 325

Profiles for blind assembly 328

Flooring profiles 330

Duo profile system 331

Pro profile system 332

Tile profiles

Tile profiles 333

Storage systems

Storage systems 336

Utility hooks made of steel 337

Utility hooks made of aluminium 345

Shelf brackets 347

Bicycle holders 349

Index

Numerical index 352

DURAVIS®

Made to last.

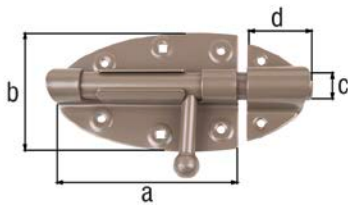

DURAVIS® Bolt lock with round handle

with countersunk screw holes
with reinforced screw holes

	Dimension a	Dimension b	Dimension c-Ø	Dimension d	UNIT	PU	Contents per PU	Deliv-ery time	Order no. 4004338...
	Material: steel, blue galvanised, Surface: pearl beige duplex-coated RAL 1035								
20	112 mm	72 mm	16 mm	36 mm	4	Piece	-	L	300012
	Material: steel, blue galvanised, Surface: rust brown duplex-coated								
20	112 mm	72 mm	16 mm	36 mm	4	Piece	-	L	300678
	Material: steel, blue galvanised, Surface: black diamond duplex-coated								
20	112 mm	72 mm	16 mm	36 mm	4	Piece	-	L	301330

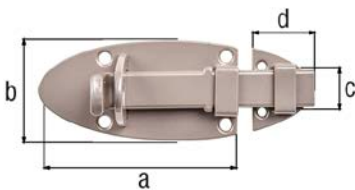

DURAVIS® Lock bolt with flat handle

with countersunk screw holes
fixation of padlock possible

Accessory note: Padlocks not included.

	Dimension a	Dimension b	Dimension c	Dimension d	UNIT	PU	Contents per PU	Deliv-ery time	Order no. 4004338...
	Material: steel, blue galvanised, Surface: pearl beige duplex-coated RAL 1035								
20	90 mm	44 mm	16 mm	27 mm	4	Piece	-	L	300005
	Material: steel, blue galvanised, Surface: rust brown duplex-coated								
20	90 mm	44 mm	16 mm	27 mm	4	Piece	-	L	300661
	Material: steel, blue galvanised, Surface: black diamond duplex-coated								
20	90 mm	44 mm	16 mm	27 mm	4	Piece	-	L	301323

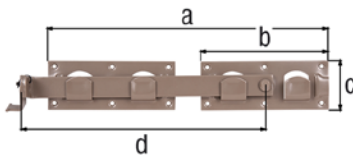

DURAVIS® Double gate hasp

with countersunk screw holes
the closing bracket can be used on both sides
applicable DIN left and right
fixation of padlock possible

Accessory note: Padlocks not included.

	Dimension a	Dimension b	Dimension c	Dimension d	UNIT	PU	Contents per PU	Deliv-ery time	Order no. 4004338...
	Material: steel, blue galvanised, Surface: pearl beige duplex-coated RAL 1035, individual parts attached with cable ties								
20	423 mm	180 mm	70 mm	333 mm	3	Piece	-	L	300043
	Material: steel, blue galvanised, Surface: rust brown duplex-coated, individual parts attached with cable ties								
20	423 mm	180 mm	70 mm	333 mm	3	Piece	-	L	300708
	Material: steel, blue galvanised, Surface: black diamond duplex-coated, individual parts attached with cable ties								
20	423 mm	180 mm	70 mm	333 mm	3	Piece	-	L	301361

DURAVIS® Garden gate latch, especially for narrow frame timbers

with countersunk screw holes

with door latch

usable with left and right stop by swivelling the bolt and changing the handle cap over

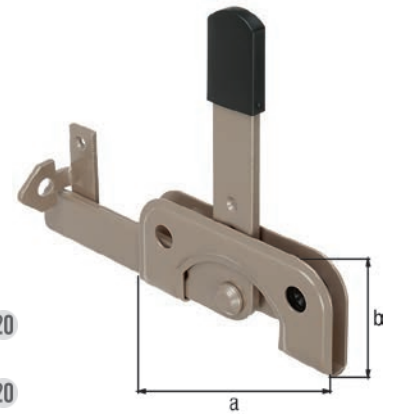

Dimension a	Dimension b	UNIT	PU	Contents per PU	Deliv-ery time	Order no. 4004338...
Material: steel, blue galvanised, Surface: pearl beige duplex-coated RAL 1035						
120 mm	50 mm	5	Piece	-	L	300067 20
Material: steel, blue galvanised, Surface: rust brown duplex-coated						
120 mm	50 mm	5	Piece	-	L	300722 20
Material: steel, blue galvanised, Surface: black diamond duplex-coated						
120 mm	50 mm	5	Piece	-	L	301385 20

DURAVIS® Fence bracket, L-shape

with wood screw

Wooden thread Ø: 8 x 45 mm

Drive: hexagon head (star) size 30

Material thickness: 2.00 mm

Assembly note: Holes with Ø 6 mm must be predrilled in the timber post before the fence bracket can be installed.

Accessory note: For easy fixation and adjustment use our drive-in tool for fence bracket no. 208790

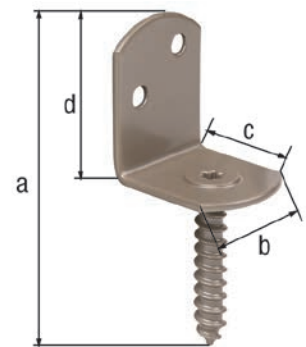

Dimension a	Dimension b	Dimension c	Dimension d	UNIT	PU	Contents per PU	Deliv-ery time	Order no. 4004338...
Material: steel, blue galvanised, Surface: pearl beige duplex-coated RAL 1035								
83 mm	30 mm	32 mm	38 mm	50	Piece	-	L	300050 20
Material: steel, blue galvanised, Surface: rust brown duplex-coated								
83 mm	30 mm	32 mm	38 mm	50	Piece	-	L	300715 20
Material: steel, blue galvanised, Surface: black diamond duplex-coated								
83 mm	30 mm	32 mm	38 mm	50	Piece	-	L	301378 20

DURAVIS® Tee hinge

with riveted pin

Accessory note: Suitable fasteners can be found in the range "Screws and accessories".

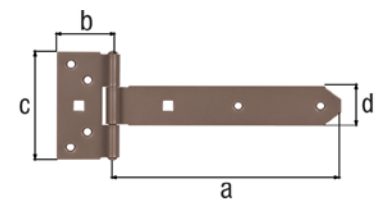

Dimension a	Dimension b	Dimension c	Dimension d	Material thickness	UNIT	PU	Contents per PU	Deliv-ery time	Order no. 4004338...
Material: steel, blue galvanised, Surface: pearl beige duplex-coated RAL 1035									
192 mm	45 mm	90 mm	34 mm	2.00 mm	6	Piece	-	L	300135 20
391 mm	59 mm	103 mm	40 mm	3.50 mm	6	Piece	-	L	300142 20
591 mm	59 mm	103 mm	40 mm	3.50 mm	6	Piece	-	L	300159 20
Material: steel, blue galvanised, Surface: rust brown duplex-coated									
192 mm	45 mm	90 mm	34 mm	2.00 mm	6	Piece	-	L	300791 20
391 mm	59 mm	103 mm	40 mm	3.50 mm	6	Piece	-	L	300807 20
591 mm	59 mm	103 mm	40 mm	3.50 mm	6	Piece	-	L	300814 20
Material: steel, blue galvanised, Surface: black diamond duplex-coated									
192 mm	45 mm	90 mm	34 mm	2.00 mm	6	Piece	-	L	301453 20
391 mm	59 mm	103 mm	40 mm	3.50 mm	6	Piece	-	L	301460 20
591 mm	59 mm	103 mm	40 mm	3.50 mm	6	Piece	-	L	301477 20

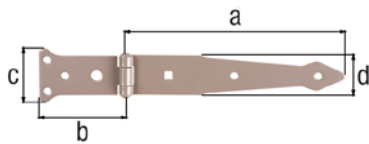

DURAVIS® Strap hinge

with riveted pin

Type: light
Material thickness: 2.50 mm

Accessory note: Suitable fasteners can be found in the range "Screws and accessories".

	Dimension a	Dimension b	Dimension c	Dimension d	UNIT	PU	Contents per PU	Deliv-ery time	Order no. 4004338...
Material: steel, blue galvanised, Surface: pearl beige duplex-coated RAL 1035									
20	202 mm	77 mm	48 mm	35 mm	6	Piece	-	L	300197
20	302 mm	77 mm	48 mm	35 mm	6	Piece	-	L	300203
Material: steel, blue galvanised, Surface: rust brown duplex-coated									
20	202 mm	77 mm	48 mm	35 mm	6	Piece	-	L	300852
20	302 mm	77 mm	48 mm	35 mm	6	Piece	-	L	300869
Material: steel, blue galvanised, Surface: black diamond duplex-coated									
20	202 mm	77 mm	48 mm	35 mm	6	Piece	-	L	301521
20	302 mm	77 mm	48 mm	35 mm	6	Piece	-	L	301538

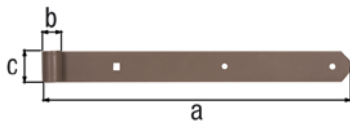

DURAVIS® Shutter hinge, straight, rounded

Material thickness: 5.00 mm

Accessory note: Suitable fasteners can be found in the range "Screws and accessories".

	Dimension a	Dimension b-Ø	Dimension c	UNIT	PU	Contents per PU	Deliv-ery time	Order no. 4004338...
Material: steel, blue galvanised, Surface: pearl beige duplex-coated RAL 1035								
20	400 mm	13 mm	40 mm	4	Piece	-	L	300166
20	600 mm	13 mm	40 mm	4	Piece	-	L	300173
20	800 mm	16 mm	45 mm	4	Piece	-	L	300180
Material: steel, blue galvanised, Surface: rust brown duplex-coated								
20	400 mm	13 mm	40 mm	4	Piece	-	L	300821
20	600 mm	13 mm	40 mm	4	Piece	-	L	300838
20	800 mm	16 mm	45 mm	4	Piece	-	L	300845
Material: steel, blue galvanised, Surface: black diamond duplex-coated								
20	400 mm	13 mm	40 mm	4	Piece	-	L	301484
20	600 mm	13 mm	40 mm	4	Piece	-	L	301491
20	800 mm	16 mm	45 mm	4	Piece	-	L	301507

DURAVIS® Hook on plate, DI

with countersunk screw holes

Accessory note: Suitable fasteners can be found in the range "Screws and accessories".

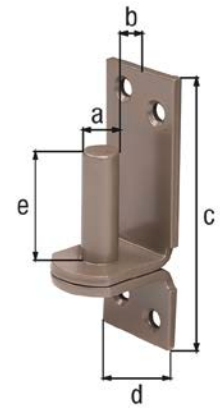

Dimension a-Ø	Dimension b	Dimension c	Dimension d	Dimension e	Material thickness	UNIT	PU	Contents per PU	Deliv-ery time	Order no. 4004338...
Material: steel, blue galvanised, Surface: pearl beige duplex-coated RAL 1035										
13 mm	11 mm	100 mm	35 mm	40 mm	4.00 mm	6	Piece	-	L	300098 20
16 mm	13 mm	115 mm	40 mm	45 mm	4.50 mm	6	Piece	-	L	300104 20
Material: steel, blue galvanised, Surface: rust brown duplex-coated										
13 mm	11 mm	100 mm	35 mm	40 mm	4.00 mm	6	Piece	-	L	300753 20
16 mm	13 mm	115 mm	40 mm	45 mm	4.50 mm	6	Piece	-	L	300760 20
Material: steel, blue galvanised, Surface: black diamond duplex-coated										
13 mm	11 mm	100 mm	35 mm	40 mm	4.00 mm	6	Piece	-	L	301415 20
16 mm	13 mm	115 mm	40 mm	45 mm	4.50 mm	6	Piece	-	L	301422 20

DURAVIS® Hook on plate, DII

with countersunk screw holes

Accessory note: Suitable fasteners can be found in the range "Screws and accessories".

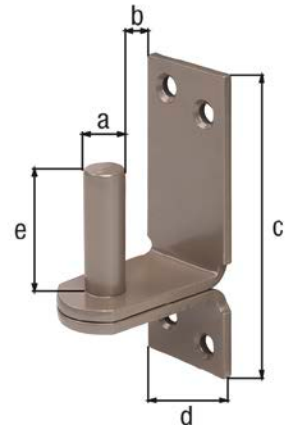

Dimension a-Ø	Dimension b	Dimension c	Dimension d	Dimension e	Material thickness	UNIT	PU	Contents per PU	Deliv-ery time	Order no. 4004338...
Material: steel, blue galvanised, Surface: pearl beige duplex-coated RAL 1035										
13 mm	25 mm	100 mm	35 mm	40 mm	4.00 mm	6	Piece	-	L	300111 20
16 mm	28 mm	113 mm	40 mm	45 mm	4.50 mm	6	Piece	-	L	300128 20
Material: steel, blue galvanised, Surface: rust brown duplex-coated										
13 mm	25 mm	100 mm	35 mm	40 mm	4.00 mm	6	Piece	-	L	300777 20
16 mm	28 mm	113 mm	40 mm	45 mm	4.50 mm	6	Piece	-	L	300784 20
Material: steel, blue galvanised, Surface: black diamond duplex-coated										
13 mm	25 mm	100 mm	35 mm	40 mm	4.00 mm	6	Piece	-	L	301439 20
16 mm	28 mm	113 mm	40 mm	45 mm	4.50 mm	6	Piece	-	L	301446 20

DURAVIS® Hinge, wide

with riveted stainless steel pin

division five-part

Type: rolled

Material thickness: 1.25 mm

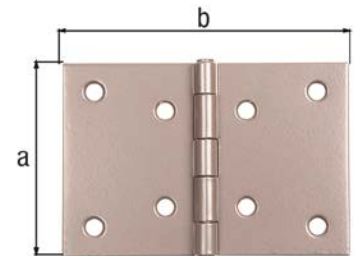

Dimension a	Dimension b	UNIT	PU	Contents per PU	Deliv-ery time	Order no. 4004338...
Material: steel, blue galvanised, Surface: pearl beige duplex-coated RAL 1035						
60 mm	90 mm	16	Piece	-	L	300517 20
Material: steel, blue galvanised, Surface: rust brown duplex-coated						
60 mm	90 mm	16	Piece	-	L	301170 20
Material: steel, blue galvanised, Surface: black diamond duplex-coated						
60 mm	90 mm	16	Piece	-	L	301835 20

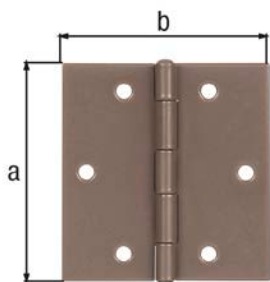

DURAVIS® Hinge, square

with riveted stainless steel pin
with countersunk screw holes

division five-part
Type: rolled
Material thickness: 1.00 mm

	Dimension a	Dimension b	UNIT	PU	Contents per PU	Deliv-ery time	Order no. 4004338...
	Material: steel, blue galvanised, Surface: pearl beige duplex-coated RAL 1035						
20	60 mm	60 mm	20	Piece	-	L	300524
	Material: steel, blue galvanised, Surface: rust brown duplex-coated						
20	60 mm	60 mm	20	Piece	-	L	301187
	Material: steel, blue galvanised, Surface: black diamond duplex-coated						
20	60 mm	60 mm	20	Piece	-	L	301842

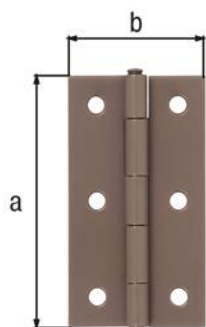

DURAVIS® Hinge, narrow

with riveted stainless steel pin
with countersunk screw holes

Type: rolled
Material thickness: 1.25 mm

	Dimension a	Dimension b	UNIT	PU	Contents per PU	Deliv-ery time	Order no. 4004338...
	Material: steel, blue galvanised, Surface: pearl beige duplex-coated RAL 1035						
20	80 mm	40 mm	20	Piece	-	L	300531
	Material: steel, blue galvanised, Surface: rust brown duplex-coated						
20	80 mm	40 mm	20	Piece	-	L	301194
	Material: steel, blue galvanised, Surface: black diamond duplex-coated						
20	80 mm	40 mm	20	Piece	-	L	301859

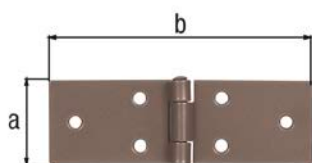

DURAVIS® Table hinge

with riveted stainless steel pin
with countersunk screw holes

Type: rolled
Material thickness: 1.50 mm

	Dimension a	Dimension b	UNIT	PU	Contents per PU	Deliv-ery time	Order no. 4004338...
	Material: steel, blue galvanised, Surface: pearl beige duplex-coated RAL 1035						
20	32 mm	100 mm	20	Piece	-	L	300586
	Material: steel, blue galvanised, Surface: rust brown duplex-coated						
20	32 mm	100 mm	20	Piece	-	L	301248
	Material: steel, blue galvanised, Surface: black diamond duplex-coated						
20	32 mm	100 mm	20	Piece	-	L	301903

DURAVIS® Box hinge

with riveted pin
with countersunk screw holes
Material thickness: 2.00 mm

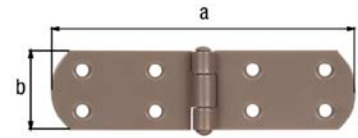

Dimension a	Dimension b	UNIT	PU	Contents per PU	Deliv-ery time	Order no. 4004338...	
Material: steel, blue galvanised, Surface: pearl beige duplex-coated RAL 1035							
135 mm	35 mm	20	Piece	-	L	300074	20
156 mm	35 mm	20	Piece	-	L	300081	20
195 mm	35 mm	20	Piece	-	L	300340	20
Material: steel, blue galvanised, Surface: rust brown duplex-coated							
135 mm	35 mm	20	Piece	-	L	300739	20
156 mm	35 mm	20	Piece	-	L	300746	20
195 mm	35 mm	20	Piece	-	L	301002	20
Material: steel, blue galvanised, Surface: black diamond duplex-coated							
135 mm	35 mm	20	Piece	-	L	301392	20
156 mm	35 mm	20	Piece	-	L	301408	20
195 mm	35 mm	20	Piece	-	L	301675	20

DURAVIS® Joist hanger angle bracket, unequal sided

with countersunk screw holes



Dimension a	Dimension b	Dimension c	Material thickness	UNIT	PU	Contents per PU	Deliv-ery time	Order no. 4004338...	
Material: steel, blue galvanised, Surface: pearl beige duplex-coated RAL 1035									
40 mm	80 mm	30 mm	2.00 mm	20	Piece	-	L	300265	20
75 mm	100 mm	30 mm	3.00 mm	50	Piece	-	L	300272	20
160 mm	240 mm	50 mm	5.00 mm	10	Piece	-	L	300289	20
Material: steel, blue galvanised, Surface: rust brown duplex-coated									
40 mm	80 mm	30 mm	2.00 mm	20	Piece	-	L	300920	20
75 mm	100 mm	30 mm	3.00 mm	50	Piece	-	L	300937	20
160 mm	240 mm	50 mm	5.00 mm	10	Piece	-	L	300944	20
Material: steel, blue galvanised, Surface: black diamond duplex-coated									
40 mm	80 mm	30 mm	2.00 mm	20	Piece	-	L	301590	20
75 mm	100 mm	30 mm	3.00 mm	50	Piece	-	L	301606	20
160 mm	240 mm	50 mm	5.00 mm	10	Piece	-	L	301613	20

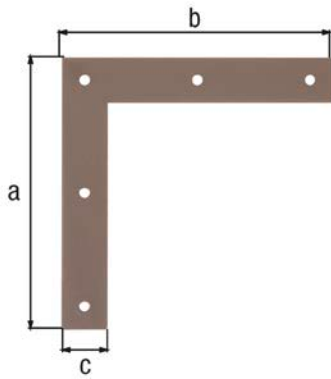

DURAVIS® Corner bracket

with countersunk screw holes
Material thickness: 1.50 mm

	Dimension a	Dimension b	Dimension c	UNIT	PU	Contents per PU	Deliv-ery time	Order no. 4004338...
	Material: steel, sendzimir galvanised, Surface: pearl beige duplex-coated RAL 1035							
20	120 mm	120 mm	20 mm	40	Piece	-	L	300296
	Material: steel, sendzimir galvanised, Surface: rust brown duplex-coated							
20	120 mm	120 mm	20 mm	40	Piece	-	L	300951
	Material: steel, sendzimir galvanised, Surface: black diamond duplex-coated							
20	120 mm	120 mm	20 mm	40	Piece	-	L	301620

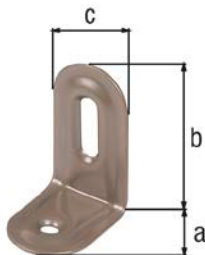

DURAVIS® Adjustable angle connector, embossed

with countersunk screw holes
Material thickness: 1.00 mm

	Dimension a	Dimension b	Dimension c	UNIT	PU	Contents per PU	Deliv-ery time	Order no. 4004338...
	Material: steel, blue galvanised, Surface: pearl beige duplex-coated RAL 1035							
20	28 mm	40 mm	22 mm	50	Piece	-	L	300593
	Material: steel, blue galvanised, Surface: rust brown duplex-coated							
20	28 mm	40 mm	22 mm	50	Piece	-	L	301255
	Material: steel, blue galvanised, Surface: black diamond duplex-coated							
20	28 mm	40 mm	22 mm	50	Piece	-	L	301910

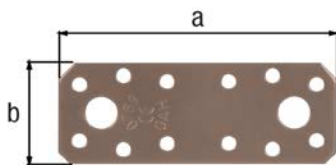

DURAVIS® Flat connector

	Dimension a	Dimension b	Material thickness	UNIT	PU	Contents per PU	Deliv-ery time	Order no. 4004338...
	Material: steel, sendzimir galvanised, Surface: pearl beige duplex-coated RAL 1035, with CE marking in accordance with DIN EN 14545							
20	96 mm	35 mm	2.50 mm	50	Piece	-	L	300319
20	133 mm	55 mm	2.50 mm	30	Piece	-	L	300326
20	180 mm	40 mm	3.00 mm	30	Piece	-	L	300333
	Material: steel, sendzimir galvanised, Surface: rust brown duplex-coated, with CE marking in accordance with DIN EN 14545							
20	96 mm	35 mm	2.50 mm	50	Piece	-	L	300975
20	133 mm	55 mm	2.50 mm	30	Piece	-	L	300982
20	180 mm	40 mm	3.00 mm	30	Piece	-	L	300999
	Material: steel, sendzimir galvanised, Surface: black diamond duplex-coated, with CE marking in accordance with DIN EN 14545							
20	96 mm	35 mm	2.50 mm	50	Piece	-	L	301644
20	133 mm	55 mm	2.50 mm	30	Piece	-	L	301651
20	180 mm	40 mm	3.00 mm	30	Piece	-	L	301668

DURAVIS® Perforated plate

Material thickness: 2.00 mm

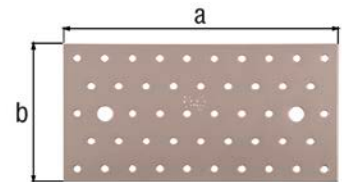

Dimension a	Dimension b	UNIT	PU	Contents per PU	Deliv-ery time	Order no. 4004338...	
Material: steel, sendzimir galvanised, Surface: pearl beige duplex-coated RAL 1035, with CE marking in accordance with DIN EN 14545							
200 mm	100 mm	25	Piece	-	L	300463	20 €
Material: steel, sendzimir galvanised, Surface: rust brown duplex-coated, with CE marking in accordance with DIN EN 14545							
200 mm	100 mm	25	Piece	-	L	301118	20 €
Material: steel, sendzimir galvanised, Surface: black diamond duplex-coated, with CE marking in accordance with DIN EN 14545							
200 mm	100 mm	25	Piece	-	L	301781	20 €

DURAVIS® Perforated angle plate

Material thickness: 2.50 mm

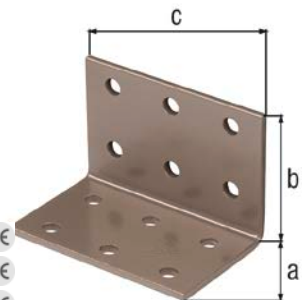

Dimension a	Dimension b	Dimension c	UNIT	PU	Contents per PU	Deliv-ery time	Order no. 4004338...	
Material: steel, sendzimir galvanised, Surface: pearl beige duplex-coated RAL 1035, with CE marking in accordance with ETA-08/0165								
40 mm	40 mm	60 mm	50	Piece	-	L	300470	20 €
60 mm	60 mm	40 mm	50	Piece	-	L	300487	20 €
60 mm	60 mm	60 mm	50	Piece	-	L	300494	20 €
80 mm	80 mm	80 mm	25	Piece	-	L	300500	20 €
Material: steel, sendzimir galvanised, Surface: rust brown duplex-coated, with CE marking in accordance with ETA-08/0165								
40 mm	40 mm	60 mm	50	Piece	-	L	301125	20 €
60 mm	60 mm	40 mm	50	Piece	-	L	301132	20 €
60 mm	60 mm	60 mm	50	Piece	-	L	301156	20 €
80 mm	80 mm	80 mm	25	Piece	-	L	301163	20 €
Material: steel, sendzimir galvanised, Surface: black diamond duplex-coated, with CE marking in accordance with ETA-08/0165								
40 mm	40 mm	60 mm	50	Piece	-	L	301798	20 €
60 mm	60 mm	40 mm	50	Piece	-	L	301804	20 €
60 mm	60 mm	60 mm	50	Piece	-	L	301811	20 €
80 mm	80 mm	80 mm	25	Piece	-	L	301828	20 €

DURAVIS® Angle bracket

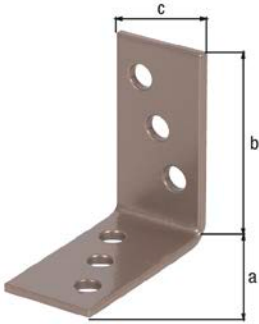

	Dimension a	Dimension b	Dimension c	Material thickness	UNIT	PU	Contents per PU	Deliv-ery time	Order no. 4004338...
Material: steel, sendzimir galvanised, Surface: pearl beige duplex-coated RAL 1035									
20	40 mm	40 mm	20 mm	2.00 mm	100	Piece	-	L	300609
20	40 mm	40 mm	40 mm	2.00 mm	50	Piece	-	L	300616
Material: steel, sendzimir galvanised, Surface: pearl beige duplex-coated RAL 1035, with CE marking in accordance with ETA-08/0165									
20 CE	50 mm	50 mm	35 mm	2.50 mm	50	Piece	-	S	300623
20 CE	50 mm	50 mm	40 mm	2.00 mm	50	Piece	-	L	300630
20 CE	90 mm	90 mm	40 mm	3.00 mm	50	Piece	-	L	300647
20 CE	100 mm	60 mm	60 mm	2.50 mm	50	Piece	-	L	300654
Material: steel, sendzimir galvanised, Surface: rust brown duplex-coated									
20	40 mm	40 mm	20 mm	2.00 mm	100	Piece	-	L	301262
20	40 mm	40 mm	40 mm	2.00 mm	50	Piece	-	L	301279
Material: steel, sendzimir galvanised, Surface: rust brown duplex-coated, with CE marking in accordance with ETA-08/0165									
20 CE	50 mm	50 mm	35 mm	2.50 mm	50	Piece	-	S	301286
20 CE	50 mm	50 mm	40 mm	2.00 mm	50	Piece	-	L	301293
20 CE	90 mm	90 mm	40 mm	3.00 mm	50	Piece	-	L	301309
20 CE	100 mm	60 mm	60 mm	2.50 mm	50	Piece	-	L	301316
Material: steel, sendzimir galvanised, Surface: black diamond duplex-coated									
20	40 mm	40 mm	20 mm	2.00 mm	100	Piece	-	L	301927
20	40 mm	40 mm	40 mm	2.00 mm	50	Piece	-	L	301934
Material: steel, sendzimir galvanised, Surface: black diamond duplex-coated, with CE marking in accordance with ETA-08/0165									
20 CE	50 mm	50 mm	35 mm	2.50 mm	50	Piece	-	S	301941
20 CE	50 mm	50 mm	40 mm	2.00 mm	50	Piece	-	L	301958
20 CE	90 mm	90 mm	40 mm	3.00 mm	50	Piece	-	L	301965
20 CE	100 mm	60 mm	60 mm	2.50 mm	50	Piece	-	L	301972

DURAVIS® Heavy-duty angle bracket reinforced

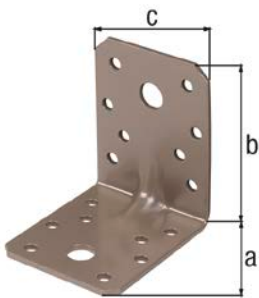

	Dimension a	Dimension b	Dimension c	Material thickness	UNIT	PU	Contents per PU	Deliv-ery time	Order no. 4004338...
Material: steel, sendzimir galvanised, Surface: pearl beige duplex-coated RAL 1035, with CE marking in accordance with ETA-08/0165									
20 CE	70 mm	70 mm	55 mm	2.50 mm	50	Piece	-	L	300548
20 CE	90 mm	90 mm	65 mm	2.50 mm	25	Piece	-	L	300555
20 CE	105 mm	105 mm	90 mm	3.00 mm	20	Piece	-	L	300562
Material: steel, sendzimir galvanised, Surface: rust brown duplex-coated, with CE marking in accordance with ETA-08/0165									
20 CE	70 mm	70 mm	55 mm	2.50 mm	50	Piece	-	L	301200
20 CE	90 mm	90 mm	65 mm	2.50 mm	25	Piece	-	L	301217
20 CE	105 mm	105 mm	90 mm	3.00 mm	20	Piece	-	L	301224
Material: steel, sendzimir galvanised, Surface: black diamond duplex-coated, with CE marking in accordance with ETA-08/0165									
20 CE	70 mm	70 mm	55 mm	2.50 mm	50	Piece	-	L	301866
20 CE	90 mm	90 mm	65 mm	2.50 mm	25	Piece	-	L	301873
20 CE	105 mm	105 mm	90 mm	3.00 mm	20	Piece	-	L	301880

DURAVIS® Joist hanger, type A

Material thickness: 2.00 mm

Dimension a	Dimension b	Dimension c	UNIT	PU	Contents per PU	Deliv-ery time	Order no. 4004338...	
Material: steel, sendzimir galvanised, Surface: pearl beige duplex-coated RAL 1035, with CE marking in accordance with ETA-08/0171								
60 mm	100 mm	138 mm	25	Piece	-	L	300210	20 CE
80 mm	120 mm	150 mm	25	Piece	-	L	300258	20 CE
Material: steel, sendzimir galvanised, Surface: rust brown duplex-coated, with CE marking in accordance with ETA-08/0171								
60 mm	100 mm	138 mm	25	Piece	-	L	300876	20 CE
80 mm	120 mm	150 mm	25	Piece	-	L	300913	20 CE
Material: steel, sendzimir galvanised, Surface: black diamond duplex-coated, with CE marking in accordance with ETA-08/0171								
60 mm	100 mm	138 mm	25	Piece	-	L	301545	20 CE
80 mm	120 mm	150 mm	25	Piece	-	L	301583	20 CE

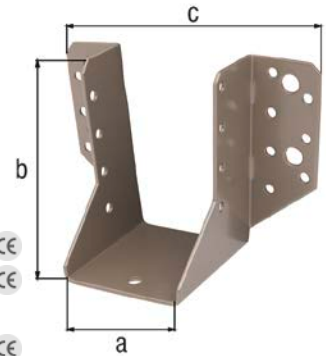

DURAVIS® Rafter purlin anchor

multifunctional

Material thickness: 2.00 mm

Dimension a	Dimension b	Dimension c	UNIT	PU	Contents per PU	Deliv-ery time	Order no. 4004338...	
Material: steel, sendzimir galvanised, Surface: pearl beige duplex-coated RAL 1035, with CE marking in accordance with ETA-14/0105								
33 mm	33 mm	170 mm	50	Piece	-	L	300579	20 CE
Material: steel, sendzimir galvanised, Surface: rust brown duplex-coated, with CE marking in accordance with ETA-14/0105								
33 mm	33 mm	170 mm	50	Piece	-	L	301231	20 CE
Material: steel, sendzimir galvanised, Surface: black diamond duplex-coated, with CE marking in accordance with ETA-14/0105								
33 mm	33 mm	170 mm	50	Piece	-	L	301897	20 CE



DURAVIS® Flat steel concrete anchor

Material thickness: 2.00 mm

Dimension a	Dimension b	Dimension c	UNIT	PU	Contents per PU	Deliv-ery time	Order no. 4004338...	
Material: steel, sendzimir galvanised, Surface: pearl beige duplex-coated RAL 1035, for setting in concrete, with CE marking in accordance with ETA-08/0165								
205 mm	40 mm	40 mm	10	Piece	-	L	300302	20 CE
Material: steel, sendzimir galvanised, Surface: rust brown duplex-coated, for setting in concrete, with CE marking in accordance with ETA-08/0165								
205 mm	40 mm	40 mm	10	Piece	-	L	300968	20 CE
Material: steel, sendzimir galvanised, Surface: black diamond duplex-coated, for setting in concrete, with CE marking in accordance with ETA-08/0165								
205 mm	40 mm	40 mm	10	Piece	-	L	301637	20 CE

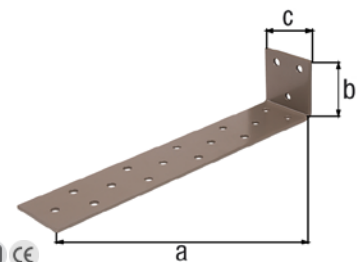



DURAVIS® Garden gate fitting set for single gates

Set components: One set consists of one garden door latch, two band hooks, 600 mm long, Ø 13 mm roller, two hooks, 13 mm pin, one nail and screw paint and a set of screws

UNIT	PU	Contents per PU	Delivery time	Order no. 4004338...
Material: steel, blue galvanised, Surface: pearl beige duplex-coated RAL 1035				
1	Box	1 Set	L	302047
Material: steel, blue galvanised, Surface: rust brown duplex-coated				
1	Box	1 Set	L	302054
Material: steel, blue galvanised, Surface: black diamond duplex-coated				
1	Box	1 Set	L	302061



DURAVIS® Garden gate fitting set for double gates

Set components: One set consists of one double gate hasp, one drop bolt, 400 mm long, one gate stop, four band hooks, 800 mm long, Ø 16 mm roller, four hooks, 16 mm pin, one nail and screw paint and a set of screws

UNIT	PU	Contents per PU	Delivery time	Order no. 4004338...
Material: steel, blue galvanised, Surface: pearl beige duplex-coated RAL 1035				
1	Box	1 Set	L	302078
Material: steel, blue galvanised, Surface: rust brown duplex-coated				
1	Box	1 Set	L	302085
Material: steel, blue galvanised, Surface: black diamond duplex-coated				
1	Box	1 Set	L	302092

DURAVIS® Nail and screw paint

for painting nails and screws as well as minor corrections
Contents: 9 ml



UNIT	PU	Contents per PU	Delivery time	Order no. 4004338...
Material: unit: bottle, colour: pearl beige RAL 1035				
6	Piece	-	L	302009
Material: unit: bottle, colour: rust brown				
6	Piece	-	L	302016
Material: unit: bottle, colour: black diamond				
6	Piece	-	L	302023

OVADO

Made to last.

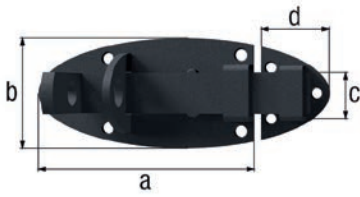

Ovado Lock bolt with flat handle

with countersunk screw holes

fixation of padlock possible

Accessory note: Padlocks not included.

Dimension a	Dimension b	Dimension c	Dimension d	UNIT	PU	Contents per PU	Deliv-ery time	Order no. 4004338...
Material: steel, Surface: galvanised, graphite grey powder-coated								
90 mm	44 mm	16 mm	27 mm	4	Piece	-	L	116712

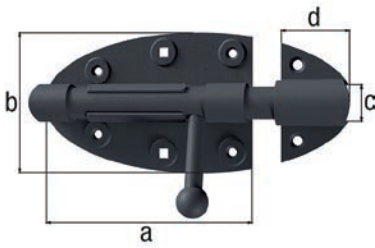

Ovado Bolt lock with round handle

with countersunk screw holes

Dimension a	Dimension b	Dimension c-Ø	Dimension d	UNIT	PU	Contents per PU	Deliv-ery time	Order no. 4004338...
Material: steel, Surface: galvanised, graphite grey powder-coated								
112 mm	72 mm	16 mm	36 mm	5	Piece	-	L	128999

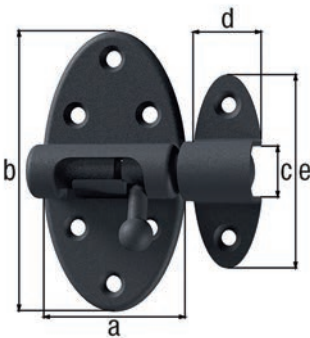

Ovado Barrel bolt with knob handle

with spring

with countersunk screw holes

· When closed, the locked head prevents undesirable loosening due to vibration.

Dimension a	Dimension b	Dimension c-Ø	Dimension d	Dimension e	UNIT	PU	Contents per PU	Deliv-ery time	Order no. 4004338...
Material: steel, Surface: galvanised, graphite grey powder-coated									
40 mm	75 mm	9 mm	19 mm	51 mm	5	Piece	-	L	128913

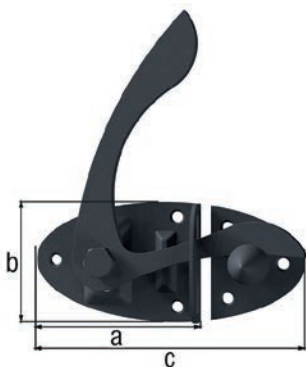

Fig. Version right

Ovado Garden gate latch

with countersunk screw holes

with door latch

applicable for left and right stop by turning the bolt height adjustable by 22 mm after mounting

Dimension a	Dimension b	Dimension c	UNIT	PU	Contents per PU	Deliv-ery time	Order no. 4004338...
Material: steel, Surface: galvanised, graphite grey powder-coated							
85 mm	60 mm	135 mm	5	Piece	-	L	210144

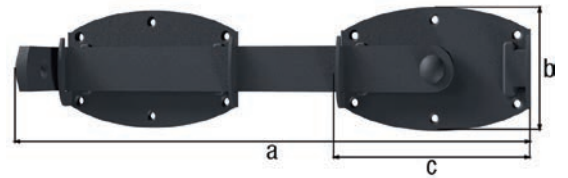

Ovado Double gate hasp

with countersunk screw holes

applicable DIN left and right
the closing bracket can be used on both sides
fixation of padlock possible

Accessory note: Padlocks not included.

Dimension a	Dimension b	Dimension c	UNIT	PU	Contents per PU	Deliv-ery time	Order no. 4004338...
Material: steel, Surface: galvanised, graphite grey powder-coated							
375 mm	80 mm	140 mm	2	Piece	-	L	210687

Ovado Fence bracket, L-shape

with countersunk screw holes

Wooden thread Ø: 8 x 45 mm
Material thickness: 2.50 mm

Dimension a	Dimension b	Dimension c	Dimension d	UNIT	PU	Contents per PU	Deliv-ery time	Order no. 4004338...
Material: steel, Surface: galvanised, graphite grey powder-coated								
120 mm	30 mm	34 mm	75 mm	20	Piece	-	L	213091

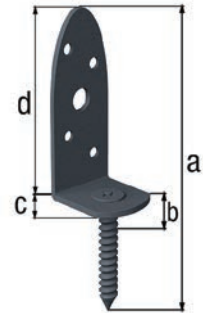

Ovado Drop bolt

with countersunk screw holes

with two guides
Distance bolt - gate: 36 mm

Dimension a	Dimension b-Ø	UNIT	PU	Contents per PU	Deliv-ery time	Order no. 4004338...
Material: steel, Surface: galvanised, graphite grey powder-coated						
400 mm	16 mm	2	Piece	-	L	207106



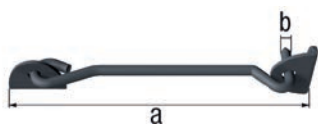

Ovado Hook and eye

with eyes on plates

Dimension a	Dimension b-Ø	UNIT	PU	Contents per PU	Deliv-ery time	Order no. 4004338...
Material: steel, Surface: galvanised, graphite grey powder-coated						
233 mm	8 mm	4	Piece	-	L	209377

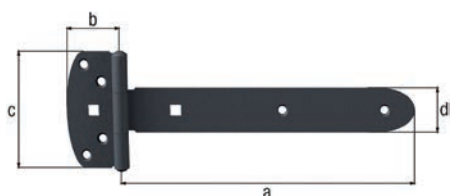

Ovado Tee hinge

with riveted pin
with countersunk screw holes

Dimension a	Dimension b	Dimension c	Dimension d	Material thickness	UNIT	Contents per PU	Deliv-ery time	Order no. 4004338...
Material: steel, Surface: galvanised, graphite grey powder-coated								
242 mm	45 mm	90 mm	34 mm	2.50 mm	6	-	L	310653
391 mm	58.7 mm	103 mm	40 mm	4.00 mm	6	-	L	310950

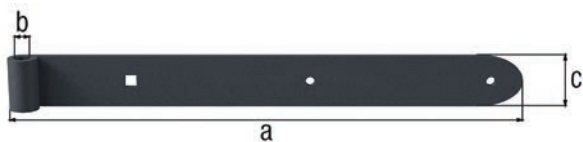

Ovado Shutter hinge, straight, rounded

Material thickness: 5.00 mm

Dimension a	Dimension b-Ø	Dimension c	UNIT	PU	Contents per PU	Deliv-ery time	Order no. 4004338...
Material: steel, Surface: galvanised, graphite grey powder-coated							
400 mm	13 mm	40 mm	4	Piece	-	L	314026
600 mm	16 mm	40 mm	4	Piece	-	L	314033

Ovado Shutter middle hinge, straight, rounded

Roller thickness: 4 mm
Material thickness: 3.00 mm

Dimension a	Dimension b	Dimension c-Ø	Dimension d	UNIT	PU	Contents per PU	Deliv-ery time	Order no. 4004338...
Material: steel, Surface: galvanised, graphite grey powder-coated								
200 mm	30 mm	13 mm	35 mm	5	Piece	-	L	313531

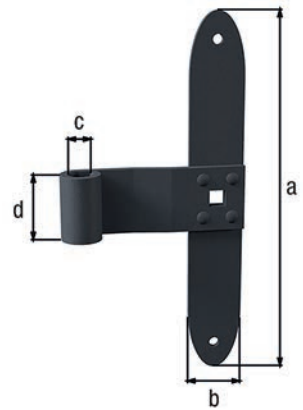

Ovado Hook on plate, DI

with countersunk screw holes

Dimension a-Ø	Dimension b	Dimension c	Dimension d	Dimension e	Material thickness	UNIT	PU	Contents per PU	Deliv-ery time	Order no. 4004338...
Material: steel, Surface: galvanised, graphite grey powder-coated, for screwing on										
13 mm	10 mm	102 mm	35 mm	40 mm	4.00 mm	4	Piece	-	L	311360
16 mm	13 mm	115 mm	52 mm	40 mm	4.50 mm	4	Piece	-	L	311377

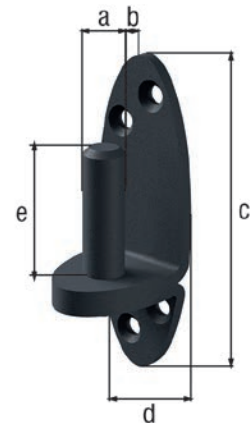

Ovado Security closing hasp

with blind screw holes
with countersunk screw holes
with eyelet
Material thickness: 2.00 mm

Dimension a	Dimension b	Dimension c	UNIT	PU	Contents per PU	Deliv-ery time	Order no. 4004338...
Material: steel, Surface: galvanised, graphite grey powder-coated							
100 mm	38 mm	29 mm	4	Piece	-	L	348328

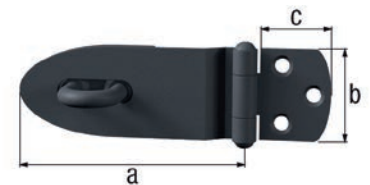

Ovado Hinge

with riveted stainless steel pin
with countersunk screw holes
Type: rolled
Material thickness: 1.00 mm

Dimension a	Dimension b	UNIT	PU	Contents per PU	Deliv-ery time	Order no. 4004338...
Material: steel, Surface: galvanised, graphite grey powder-coated						
64 mm	62 mm	6	Piece	-	L	347031

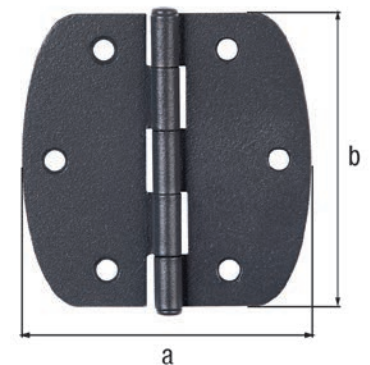

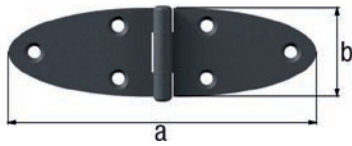

Ovado Table hinge

with riveted stainless steel pin
with countersunk screw holes

Type: rolled
Material thickness: 1.50 mm

Dimension a	Dimension b	UNIT	PU	Contents per PU	Deliv-ery time	Order no. 4004338...
Material: steel, Surface: galvanised, graphite grey powder-coated						
101 mm	32 mm	10	Piece	-	L	347093

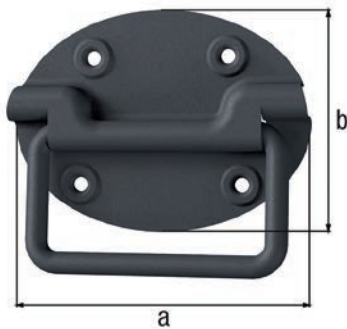

Ovado Box handle

Depth: 12 mm
Material thickness: 1.20 mm

Dimension a	Dimension b	UNIT	PU	Contents per PU	Deliv-ery time	Order no. 4004338...
Material: steel, Surface: galvanised, graphite grey powder-coated						
110 mm	80 mm	8	Piece	-	L	347840



Ovado Joist hanger angle bracket, unequal sided

with countersunk screw holes
Material thickness: 4.00 mm

Dimension a	Dimension b	Dimension c	UNIT	PU	Contents per PU	Deliv-ery time	Order no. 4004338...
Material: steel, Surface: galvanised, graphite grey powder-coated							
80 mm	120 mm	35 mm	12	Piece	-	L	333652

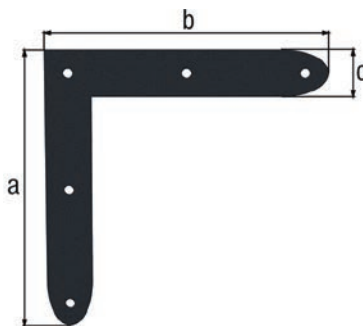

Ovado Corner bracket

Material thickness: 1.50 mm

Dimension a	Dimension b	Dimension c	UNIT	PU	Contents per PU	Deliv-ery time	Order no. 4004338...
Material: steel, Surface: galvanised, graphite grey powder-coated							
120 mm	120 mm	20 mm	12	Piece	-	L	333669

Ovado Flat connector

Material thickness: 2.50 mm

Dimension a	Dimension b	UNIT	PU	Contents per PU	Delivery time	Order no. 4004338...
Material: steel, Surface: galvanised, graphite grey powder-coated						
135 mm	55 mm	12	Piece	-	L	333676

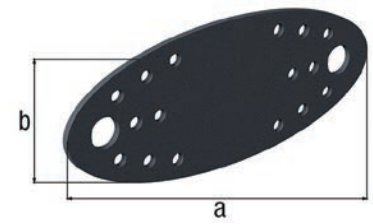

Ovado Perforated plate

Material thickness: 2.00 mm

Dimension a	Dimension b	UNIT	PU	Contents per PU	Delivery time	Order no. 4004338...
Material: steel, Surface: galvanised, graphite grey powder-coated						
240 mm	80 mm	12	Piece	-	L	333829

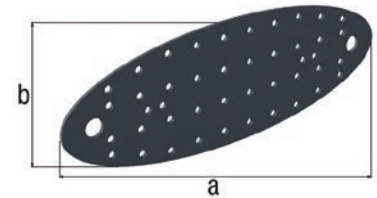

Ovado Perforated angle plate

Material thickness: 2.50 mm

Dimension a	Dimension b	Dimension c	UNIT	PU	Contents per PU	Delivery time	Order no. 4004338...
Material: steel, Surface: galvanised, graphite grey powder-coated							
60 mm	60 mm	40 mm	12	Piece	-	L	333867

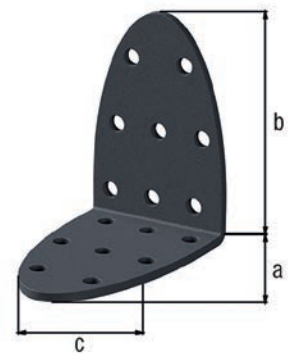

Ovado Angle bracket

Material thickness: 2.00 mm

Dimension a	Dimension b	Dimension c	UNIT	PU	Contents per PU	Delivery time	Order no. 4004338...
Material: steel, Surface: galvanised, graphite grey powder-coated							
40 mm	40 mm	40 mm	12	Piece	-	L	333942
50 mm	50 mm	40 mm	12	Piece	-	L	333966

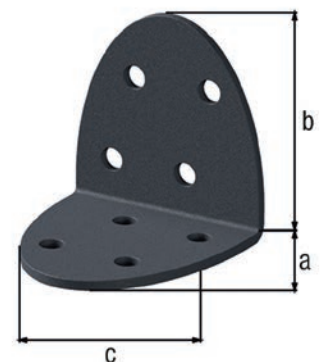

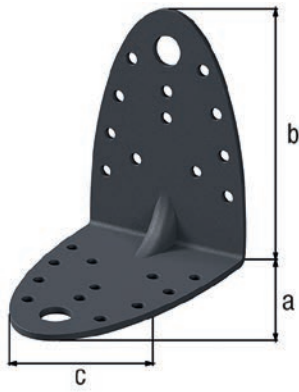

Ovado Heavy-duty angle bracket, reinforced

Material thickness: 2.50 mm

Dimension a	Dimension b	Dimension c	UNIT	PU	Contents per PU	Deliv-ery time	Order no.
90 mm	90 mm	65 mm	12	Piece	-	L	4004338...
Material: steel, Surface: galvanised, graphite grey powder-coated							
							339876

BOLTS

Made to last.



Furniture bolt with knob handle

with countersunk screw holes

Extension length: 8 mm

Dimension a	Dimension b	Dimension c	Dimension d	Dimension e	UNIT	PU	Contents per PU	Deliv-ery time	Order no. 4004338...
Material: raw steel, Surface: brass-plated, type: straight, with stop angle									
70 mm	16 mm	9 mm	13.5 mm	17 mm	25	Piece	-	L	111618
Material: raw steel, Surface: nickel-plated, type: straight, with stop angle bracket									
70 mm	16 mm	9 mm	13.5 mm	17 mm	25	Piece	-	L	111663

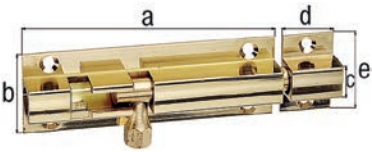

Barrel bolt with knob handle

with countersunk screw holes

Extension length: 13 mm

- When closed, the locked head prevents undesirable loosening due to vibration.

Dimension a	Dimension b	Dimension c-Ø	Dimension d	Dimension e	UNIT	PU	Contents per PU	Deliv-ery time	Order no. 4004338...
Material: brass, Surface: nickel-plated, polished, with attached staple									
63 mm	26 mm	7.3 mm	16 mm	26 mm	10	Piece	-	L	124618

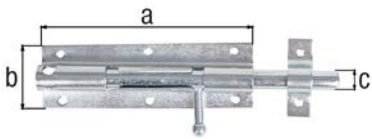

Barrel bolt with knob handle, without spring

Dimension a	Dimension b	Dimension c-Ø	Extension length	UNIT	PU	Contents per PU	Deliv-ery time	Order no. 4004338...
Material: raw steel, Surface: blue galvanised, with attached staple								
175 mm	55 mm	15.5 mm	70 mm	6	Piece	-	L	123284

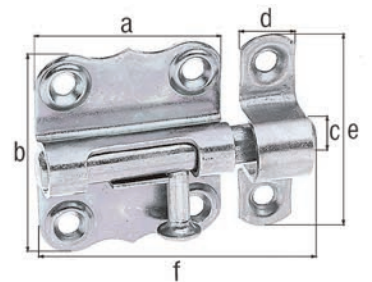

Barrel bolt with knob handle

without spring

with countersunk screw holes

with reinforced screw holes

- When closed, the locked head prevents undesirable loosening due to vibration.

Dimen-sion a	Dimen-sion b	Dimen-sion c-Ø	Dimen-sion d	Dimen-sion e	Dimen-sion f	Extension length	UNIT	PU	Contents per PU	Deliv-ery time	Order no. 4004338...
Material: raw steel, Surface: galvanised, thick-film passivated, with attached staple											
33 mm	35 mm	7 mm	10 mm	37 mm	50 mm	16 mm	12	Piece	-	L	123352
39 mm	38 mm	8 mm	10 mm	37 mm	65 mm	22 mm	12	Piece	-	L	123369
47 mm	46 mm	9 mm	13 mm	52 mm	80 mm	27 mm	12	Piece	-	L	123376
Material: stainless steel, with attached staple											
39 mm	38 mm	8 mm	10 mm	37 mm	61 mm	22 mm	6	Piece	-	L	327026

Barrel bolt with knob handle

with countersunk screw holes
without spring

with pre-punched, bendable staple

- When closed, the locked head prevents undesirable loosening due to vibration.

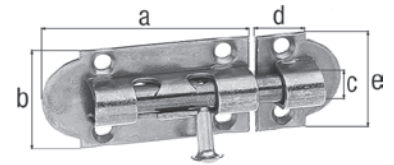

Dimension a	Dimension b	Dimension c-Ø	Dimension d	Dimension e	Extension length	UNIT	PU	Contents per PU	Deliv-ery time	Order no. 4004338...
Material: raw steel, Surface: galvanised, thick-film passivated, with attached staple										
75 mm	28 mm	7 mm	22 mm	28 mm	19 mm	12	Piece	-	L	124076
100 mm	30 mm	8 mm	27 mm	30 mm	22 mm	12	Piece	-	L	124083
Material: raw steel, Surface: blue galvanised, with attached staple										
100 mm	30 mm	8 mm	27 mm	30 mm	22 mm	12	Piece	-	L	124144

Barrel bolt with brass knob

with spring
with countersunk screw holes

- When closed, the locked head prevents undesirable loosening due to vibration.

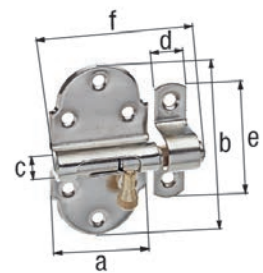

Dimen-sion a	Dimen-sion b	Dimen-sion c-Ø	Dimen-sion d	Dimen-sion e	Dimen-sion f	Extension length	UNIT	PU	Contents per PU	Deliv-ery time	Order no. 4004338...
Material: raw steel, Surface: nickel-plated, polished, with attached staple											
40 mm	75 mm	9 mm	13 mm	52 mm	60 mm	20 mm	10	Piece	-	L	128869
45 mm	85 mm	10 mm	13 mm	52 mm	80 mm	30 mm	10	Piece	-	L	128876
Material: raw steel, Surface: galvanised, thick-film passivated, with attached staple											
40 mm	75 mm	9 mm	13 mm	52 mm	60 mm	20 mm	10	Piece	-	L	128944
45 mm	85 mm	10 mm	13 mm	52 mm	80 mm	30 mm	10	Piece	-	L	128890

Window bolt with knob handle

Dimen-sion a	Dimen-sion b	Dimen-sion c	Dimen-sion d	Dimen-sion e	Extension length	UNIT	PU	Contents per PU	Deliv-ery time	Order no. 4004338...
Material: raw steel, Surface: galvanised, thick-film passivated, type: straight, with attached staple										
61 mm	26 mm	7.5 mm	10 mm	30 mm	13.5 mm	10	Piece	-	L	113001
80 mm	30 mm	10 mm	10 mm	30 mm	19.5 mm	10	Piece	-	L	113018
100 mm	30 mm	11.5 mm	13 mm	38 mm	29.0 mm	10	Piece	-	L	113025
Material: raw steel, Surface: galvanised, thick-film passivated, type: cranked, with attached locking plate										
80 mm	30 mm	10 mm	22 mm	40 mm	12.0 mm	10	Piece	-	L	113216
Material: raw steel, Surface: blue galvanised, type: straight, with attached staple										
61 mm	26 mm	7.5 mm	10 mm	30 mm	13.5 mm	10	Piece	-	L	112998
80 mm	30 mm	10 mm	10 mm	30 mm	19.5 mm	10	Piece	-	L	113100
100 mm	30 mm	11.5 mm	13 mm	38 mm	29.0 mm	10	Piece	-	L	113117
Material: raw steel, Surface: blue galvanised, type: cranked, with attached locking plate										
80 mm	30 mm	10 mm	22 mm	40 mm	12.0 mm	10	Piece	-	L	113124
Material: stainless steel, version: straight with attached staple										
80 mm	26 mm	10.5 mm	10 mm	40 mm	18.5 mm	10	Piece	-	L	113261

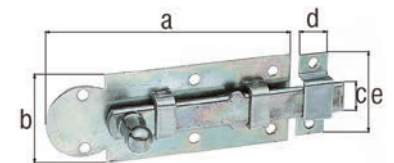

VA

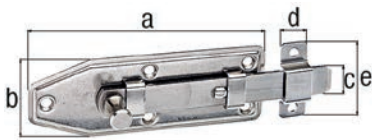

Window bolt with knob handle

with countersunk screw holes

Extension length: 29 mm

Dimension a	Dimension b	Dimension c	Dimension d	Dimension e	UNIT	PU	Contents per PU	Deliv-ery time	Order no. 4004338...
Material: stainless steel, version: straight with attached staple									
VA 100 mm	35 mm	12 mm	12 mm	35 mm	5	Piece	-	L	113278

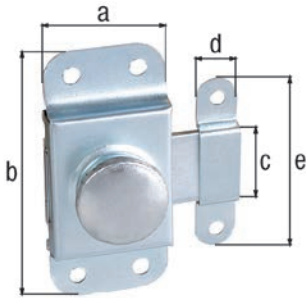

Turning bolt

Dimension a	Dimension b	Dimension c	Dimension d	Dimension e	Extension length	UNIT	PU	Contents per PU	Deliv-ery time	Order no. 4004338...
Material: raw steel, Surface: blue galvanised, with staple										
30 mm	69 mm	19 mm	12 mm	55 mm	17 mm	12	Piece	-	L	111687

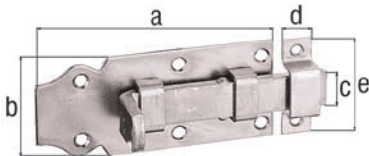

Door bolt with flat handle

with countersunk screw holes

Dimension a	Dimension b	Dimension c	Dimension d	Dimension e	Extension length	UNIT	PU	Contents per PU	Deliv-ery time	Order no. 4004338...
Material: raw steel, Surface: galvanised, thick-film passivated, type: straight, with attached staple										
100 mm	44 mm	16 mm	13 mm	45 mm	23.0 mm	10	Piece	-	L	134402
Material: raw steel, Surface: blue galvanised, type: straight, with attached staple										
100 mm	44 mm	16 mm	13 mm	45 mm	23.0 mm	10	Piece	-	L	134396

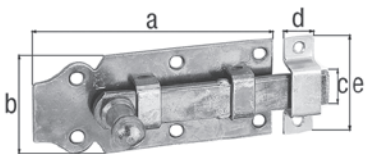

Door bolt with knob handle

with countersunk screw holes

Dimension a	Dimension b	Dimension c	Dimension d	Dimension e	Extension length	UNIT	PU	Contents per PU	Deliv-ery time	Order no. 4004338...
Material: raw steel, Surface: galvanised, thick-film passivated, type: straight, with attached staple										
100 mm	44 mm	16 mm	13 mm	45 mm	23 mm	10	Piece	-	L	115388
120 mm	44 mm	16 mm	13 mm	45 mm	27 mm	10	Piece	-	L	115395
140 mm	52 mm	20 mm	16 mm	55 mm	35 mm	10	Piece	-	L	115401
160 mm	56 mm	22 mm	16 mm	55 mm	41 mm	5	Piece	-	L	115418
Material: raw steel, Surface: blue galvanised, type: straight, with attached staple										
120 mm	44 mm	16 mm	13 mm	45 mm	27 mm	10	Piece	-	L	115371
140 mm	52 mm	20 mm	16 mm	55 mm	35 mm	10	Piece	-	L	115364
Material: raw steel, Surface: blue galvanised, type: cranked, with attached locking plate										
120 mm	44 mm	16 mm	22 mm	40 mm	18.5 mm	10	Piece	-	L	115425

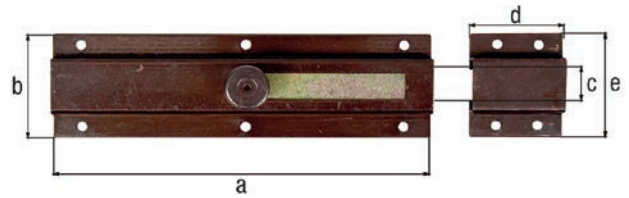

Door bolt with knob handle

for horizontal locking
Extension length: 78 mm

Dimension a	Dimension b	Dimension c	Dimension d	Dimension e	UNIT	PU	Contents per PU	Delivery time	Order no. 4004338...
Material: raw steel, Surface: browned, with staple									
200 mm	57 mm	25 mm	50 mm	58 mm	5	Piece	-	L	111793
Material: raw steel, Surface: galvanised, thick-film passivated, with staple									
200 mm	57 mm	25 mm	50 mm	58 mm	5	Piece	-	L	111809

Lock bolt with flat handle

with countersunk screw holes

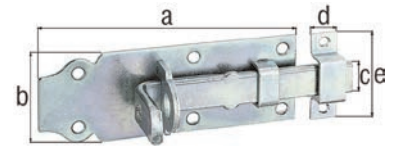

Dimension a	Dimension b	Dimension c	Dimension d	Dimension e	Extension length	UNIT	PU	Contents per PU	Delivery time	Order no. 4004338...
Material: raw steel, Surface: galvanised, thick-film passivated, type: straight, with attached staple										
100 mm	44 mm	16 mm	13 mm	45 mm	27 mm	10	Piece	-	L	116750
120 mm	44 mm	16 mm	13 mm	45 mm	33 mm	10	Piece	-	L	116767
140 mm	52 mm	20 mm	16 mm	55 mm	41 mm	10	Piece	-	L	116774
160 mm	56 mm	22 mm	16 mm	55 mm	44 mm	5	Piece	-	L	116781
180 mm	64 mm	25 mm	20 mm	72 mm	56 mm	5	Piece	-	L	116743
200 mm	64 mm	25 mm	20 mm	73 mm	65 mm	5	Piece	-	L	116798
Material: raw steel, Surface: galvanised, thick-film passivated, type: cranked, with attached locking plate										
120 mm	44 mm	16 mm	22 mm	40 mm	25 mm	10	Piece	-	L	117030
140 mm	52 mm	20 mm	20 mm	47 mm	30 mm	10	Piece	-	L	117047
Material: raw steel, Surface: blue galvanised, type: straight, with attached staple										
100 mm	44 mm	16 mm	13 mm	45 mm	27 mm	10	Piece	-	L	116866
120 mm	44 mm	16 mm	13 mm	45 mm	33 mm	10	Piece	-	L	116873
140 mm	52 mm	20 mm	16 mm	55 mm	41 mm	10	Piece	-	L	116880
Material: raw steel, Surface: blue galvanised, type: cranked, with attached locking plate										
140 mm	52 mm	20 mm	20 mm	47 mm	30 mm	10	Piece	-	L	117078
Material: raw steel, Surface: blue galvanised, type: straight, with attached staple										
140 mm	54 mm	18 mm	12 mm	54 mm	33 mm	10	Piece	-	L	111656
Material: stainless steel, version: straight with attached staple										
100 mm	45 mm	16 mm	10 mm	46 mm	27 mm	10	Piece	-	L	116934 VA
120 mm	45 mm	16 mm	10 mm	46 mm	34 mm	10	Piece	-	L	116910 VA
140 mm	52 mm	18 mm	14 mm	61 mm	40 mm	10	Piece	-	L	116927 VA

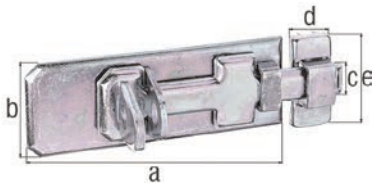

Security lock bolt with flat handle

with countersunk screw holes

When the slider is pushed forward, the countersunk screw holes of the locking plate are covered and the screws cannot be removed. The staple is secured by the drive-in plate which is hidden by the slider that is pushed forward.

Dimension a	Dimension b	Dimension c	Dimension d	Dimension e	Extension length	UNIT	PU	Contents per PU	Delivery time	Order no. 4004338...
Material: raw steel, Surface: galvanised, thick-film passivated, type: straight, with attached staple										
80 mm	35 mm	13 mm	18 mm	41 mm	20 mm	10	Piece	-	L	123055
100 mm	40 mm	15 mm	20 mm	45 mm	25 mm	10	Piece	-	L	123062
120 mm	45 mm	17 mm	22 mm	50 mm	30 mm	10	Piece	-	L	123079
140 mm	55 mm	20 mm	24 mm	56 mm	35 mm	5	Piece	-	L	123086
Material: stainless steel, version: straight with attached staple										
VA 100 mm	40 mm	14 mm	20 mm	45 mm	25 mm	6	Piece	-	L	327002

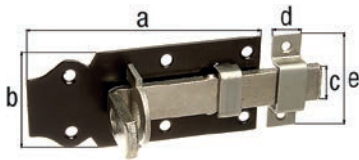

Lock bolt with flat handle

with countersunk screw holes

Dimension a	Dimension b	Dimension c	Dimension d	Dimension e	Extension length	UNIT	PU	Contents per PU	Delivery time	Order no. 4004338...
Material: raw steel, Surface: blue galvanised, plate black painted, type: straight with attached staple										
100 mm	44 mm	16 mm	13 mm	45 mm	27 mm	10	Piece	-	L	116064
120 mm	44 mm	16 mm	13 mm	45 mm	33 mm	10	Piece	-	L	116071
140 mm	52 mm	20 mm	16 mm	55 mm	41 mm	10	Piece	-	L	116088

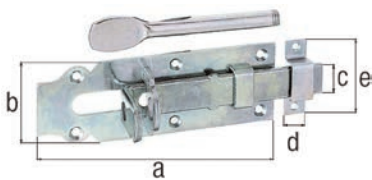

Barn flush bolt with flat handle

with countersunk screw holes

Threaded to screw the pin into the back of the slider. The pin that has been screwed in on the back allows the gate to be opened from the inside. Pin length: 128 mm

Accessory note: Pin not attached

Dimension a	Dimension b	Dimension c	Dimension d	Dimension e	Extension length	UNIT	PU	Contents per PU	Delivery time	Order no. 4004338...
Material: raw steel, Surface: galvanised, thick-film passivated, type: straight, with attached staple										
160 mm	56 mm	22 mm	16 mm	55 mm	42 mm	5	Piece	-	L	117184
180 mm	64 mm	25 mm	20 mm	72 mm	57 mm	5	Piece	-	L	117160

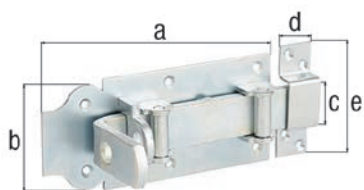

Lockable roller bolt with flat handle

with countersunk screw holes

Dimension a	Dimension b	Dimension c	Dimension d	Dimension e	Extension length	UNIT	PU	Contents per PU	Delivery time	Order no. 4004338...
Material: raw steel, Surface: galvanised, thick-film passivated, type: straight, with attached staple										
180 mm	80 mm	30 mm	26 mm	86 mm	40 mm	3	Piece	-	L	118563

Lockable barn roller bolt with flat handle

with countersunk screw holes

Threaded to screw the pin into the back of the slider.
The pin that has been screwed in on the back allows the gate to be opened from the inside.
Pin length: 123 mm
Extension length: 47 mm

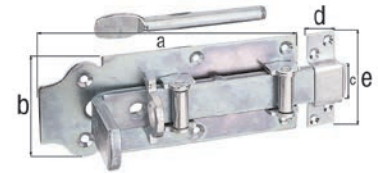

Accessory note: Pin not attached

Dimension a	Dimension b	Dimension c	Dimension d	Dimension e	UNIT	PU	Contents per PU	Delivery time	Order no. 4004338...
Material: raw steel, Surface: galvanised, thick-film passivated, type: straight, with attached staple									
200 mm	80 mm	30 mm	26 mm	86 mm	5	Piece	-	L	118815

Bolt lock with round handle

with countersunk screw holes

Dimension a	Dimension b	Dimension c-Ø	Dimension d	Dimension e	Dimension f	Extension length	UNIT	PU	Contents per PU	Delivery time	Order no. 4004338...
Material: raw steel, Surface: galvanised, thick-film passivated, with attached staple											
80 mm	59 mm	10 mm	16 mm	58 mm	125 mm	43 mm	6	Piece	-	L	128975
100 mm	59 mm	10 mm	16 mm	58 mm	145 mm	44 mm	6	Piece	-	L	128982
Material: raw steel, Surface: blue galvanised, with attached staple											
100 mm	59 mm	10 mm	16 mm	58 mm	145 mm	44 mm	6	Piece	-	L	128142
Material: stainless steel, with attached staple											
80 mm	59 mm	11 mm	16 mm	59 mm	122 mm	41 mm	6	Piece	-	L	327040 VA

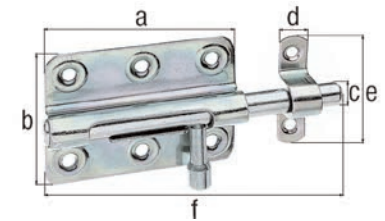

Bolt lock with round handle

Dimension a	Dimension b	Dimension c-Ø	Dimension d	Dimension e	Dimension f	Extension length	UNIT	PU	Contents per PU	Delivery time	Order no. 4004338...
Material: raw steel, Surface: blue galvanised, with attached staple											
70 mm	57 mm	9.5 mm	16 mm	53 mm	100 mm	32 mm	10	Piece	-	L	137298
80 mm	63 mm	11.5 mm	18 mm	56 mm	116 mm	35 mm	10	Piece	-	L	137038
90 mm	67 mm	13.5 mm	18 mm	61 mm	130 mm	40 mm	10	Piece	-	L	137045
95 mm	67 mm	15.5 mm	18 mm	67 mm	135 mm	43 mm	10	Piece	-	L	137052
Material: raw steel, Surface: blue galvanised, black powder-coated, with fixed staple											
70 mm	57 mm	9.5 mm	16 mm	53 mm	100 mm	32 mm	10	Piece	-	L	137281
80 mm	63 mm	11.5 mm	18 mm	56 mm	116 mm	35 mm	10	Piece	-	L	137007
90 mm	67 mm	13.5 mm	18 mm	61 mm	130 mm	40 mm	10	Piece	-	L	137014
95 mm	67 mm	15.5 mm	18 mm	67 mm	135 mm	43 mm	10	Piece	-	L	137021

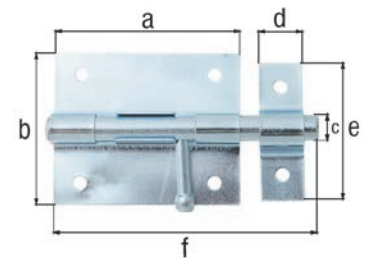

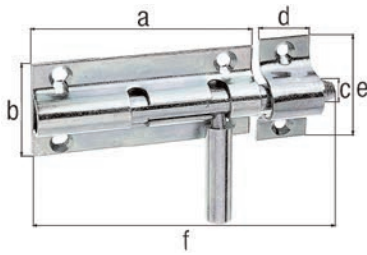

Bolt lock with round handle

with countersunk screw holes

Dimension a	Dimension b	Dimension c-Ø	Dimension d	Dimension e	Dimension f	Extension length	UNIT	PU	Contents per PU	Delivery time	Order no. 4004338...
Material: raw steel, Surface: galvanised, thick-film passivated, with attached staple											
80 mm	36 mm	10 mm	20 mm	41 mm	110 mm	29 mm	10	Piece	-	L	127763
120 mm	41 mm	12 mm	20 mm	51 mm	160 mm	37 mm	10	Piece	-	L	127961
160 mm	60 mm	16 mm	25 mm	60 mm	210 mm	50 mm	5	Piece	-	L	128166
Material: raw steel, Surface: blue galvanised, with attached staple											
160 mm	60 mm	16 mm	25 mm	60 mm	210 mm	50 mm	5	Piece	-	L	128159

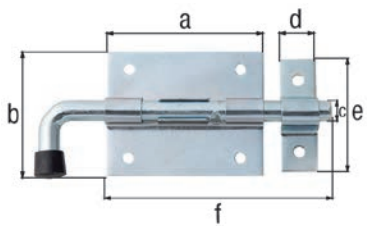

Bolt lock with round handle

Dimension a	Dimension b	Dimension c-Ø	Dimension d	Dimension e	Dimension f	Extension length	UNIT	PU	Contents per PU	Delivery time	Order no. 4004338...
Material: raw steel, Surface: blue galvanised, with attached staple											
70 mm	57 mm	9.5 mm	16 mm	53 mm	130 mm	31	10	Piece	-	L	137571
80 mm	66 mm	11.5 mm	18 mm	56 mm	143 mm	33	10	Piece	-	L	137588
90 mm	67 mm	13.5 mm	18 mm	61 mm	165 mm	38	10	Piece	-	L	137595
95 mm	67 mm	15.5 mm	18 mm	67 mm	178 mm	39	10	Piece	-	L	137601

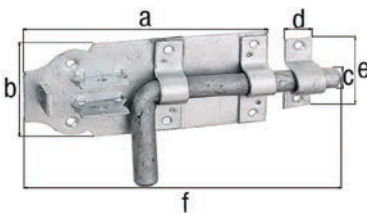

Bolt lock with round handle

with countersunk screw holes

Extension length: 49 mm

Dimension a	Dimension b	Dimension c-Ø	Dimension d	Dimension e	Dimension f	UNIT	PU	Contents per PU	Delivery time	Order no. 4004338...
Material: raw steel, Surface: hot-dip galvanised, with attached staple										
160 mm	70 mm	16 mm	20 mm	58 mm	210 mm	5	Piece	-	L	124359
180 mm	70 mm	16 mm	20 mm	58 mm	230 mm	5	Piece	-	L	124366

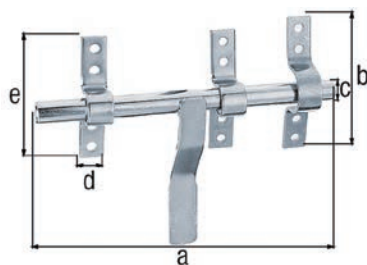

Bolt lock with flat handle, type Vervelle

adjustable extension length

Dimension a	Dimension b	Dimension c-Ø	Dimension d	Dimension e	UNIT	PU	Contents per PU	Delivery time	Order no. 4004338...
Material: raw steel, Surface: blue galvanised, with attached staple									
190 mm	93 mm	14 mm	16 mm	83 mm	5	Piece	-	L	204501

Locking tower bolt with round knob

with countersunk screw holes

with reinforced screw holes

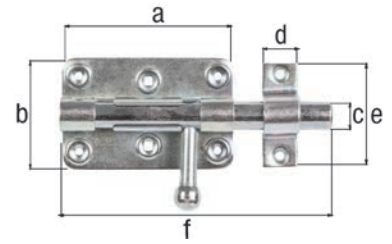

Dimension a	Dimension b	Dimension c-Ø	Dimension d	Dimension e	Dimension f	Extension length	UNIT	PU	Contents per PU	Delivery time	Order no. 4004338...
Material: raw steel, Surface: galvanised, thick-film passivated, with attached staple											
99 mm	68 mm	15 mm	20 mm	58 mm	140 mm	56 mm	6	Piece	-	L	129026
Material: stainless steel, with attached staple											
100 mm	65 mm	15.5 mm	20 mm	60 mm	153 mm	37 mm	4	Piece	-	L	327019

VA

Locking tower bolt with flat handle

Dimension a	Dimension b	Dimension c-Ø	Dimension d	Dimension e	Dimension f	Extension length	UNIT	PU	Contents per PU	Delivery time	Order no. 4004338...
Material: raw steel, Surface: blue galvanised, with attached staple											
70 mm	67 mm	9.5 mm	16 mm	53 mm	100 mm	29 mm	10	Piece	-	L	137076
80 mm	64 mm	11.5 mm	18 mm	57 mm	116 mm	35 mm	10	Piece	-	L	137083
90 mm	73 mm	13.5 mm	18 mm	61 mm	130 mm	40 mm	10	Piece	-	L	137090
95 mm	79 mm	15.5 mm	18 mm	67 mm	135 mm	42 mm	10	Piece	-	L	137106
Material: raw steel, Surface: blue galvanised, black powder-coated, with fixed staple											
70 mm	67 mm	9.5 mm	16 mm	53 mm	100 mm	29 mm	10	Piece	-	L	137304
80 mm	64 mm	11.5 mm	18 mm	57 mm	116 mm	35 mm	10	Piece	-	L	137311
90 mm	73 mm	13.5 mm	18 mm	61 mm	130 mm	40 mm	10	Piece	-	L	137328
95 mm	79 mm	15.5 mm	18 mm	67 mm	135 mm	42 mm	10	Piece	-	L	137335

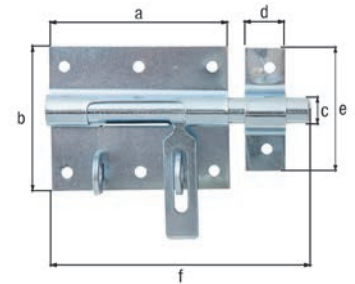

Locking tower bolt with flat handle

fixation of padlock possible

Extension length: 62.5 mm

Dimension a	Dimension b	Dimension c	Dimension d	Dimension e	Extension length	UNIT	PU	Contents per PU	Delivery time	Order no. 4004338...
280 mm	60 mm	340 mm	16 mm	110 mm	62.5 mm	5	Piece	-	L	210601

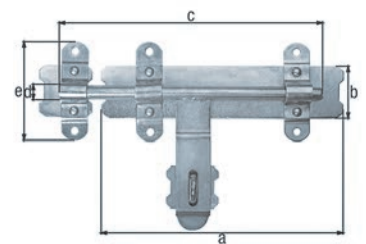

Locking tower bolt

Extension length: 32 mm

Material thickness: 1.25 mm

Dimension a	Dimension b	Dimension c-Ø	Dimension d	Dimension e	Dimension f	Extension length	UNIT	PU	Contents per PU	Delivery time	Order no. 4004338...
100 mm	51 mm	9.8 mm	13 mm	48 mm	115 mm	32 mm	10	Piece	-	L	124212

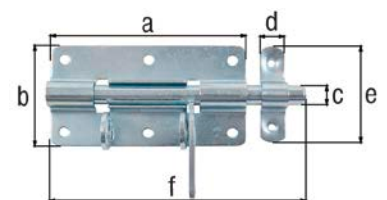

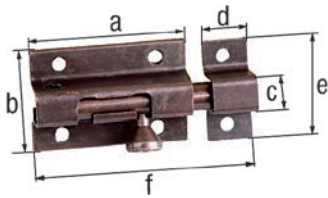

Bolt lock with knob handle

Dimension a	Dimension b	Dimension c-Ø	Dimension d	Dimension e	Dimension f	Extension length	UNIT	PU	Contents per PU	Delivery time	Order no. 4004338...
Material: raw steel, Surface: galvanised, thick-film passivated, with attached staple											
50 mm	33 mm	9 mm	15 mm	33 mm	70 mm	17 mm	10	Piece	-	L	111700
70 mm	33 mm	9 mm	31 mm	33 mm	110 mm	38 mm	10	Piece	-	L	111724
90 mm	33 mm	9 mm	50 mm	33 mm	150 mm	57 mm	10	Piece	-	L	111748

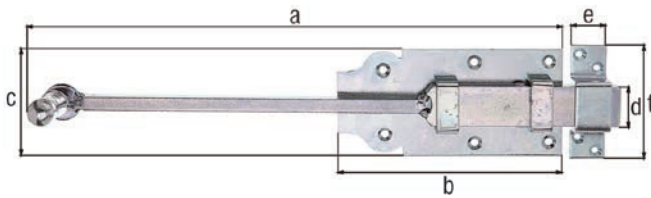

Door bolt with knob handle

with countersunk screw holes

for locking the second gate leaf at the top and bottom

Extension length: 40 mm

Square bar: 10 x 10 mm

Dimension a	Dimension b	Dimension c	Dimension d	Dimension e	Dimension f	UNIT	PU	Contents per PU	Delivery time	Order no. 4004338...
Material: raw steel, Surface: galvanised, thick-film passivated, with attached staple										
365.8 mm	160 mm	80 mm	30 mm	26 mm	86 mm	5	Piece	-	L	123154

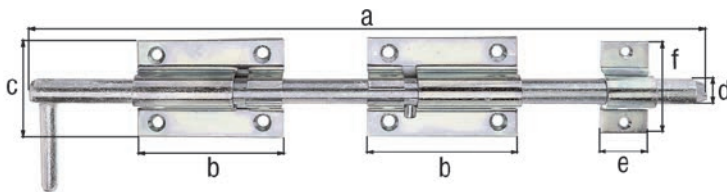

Tower drop bolt

with countersunk screw holes

adjustable extension length

Dimension a	Dimension b	Dimension c	Dimension d-Ø	Dimension e	Dimension f	UNIT	PU	Contents per PU	Delivery time	Order no. 4004338...
Material: raw steel, Surface: galvanised, thick-film passivated, with attached staple										
400 mm	90 mm	60 mm	16 mm	30 mm	57 mm	5	Piece	-	L	128500
600 mm	90 mm	60 mm	16 mm	30 mm	57 mm	5	Piece	-	L	128517

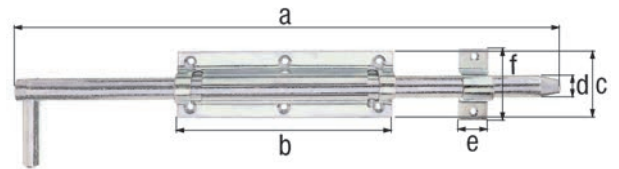

Tower drop bolt

with countersunk screw holes

Dimension a	Dimension b	Dimension c	Dimension d-Ø	Dimension e	Dimension f	Extension length	UNIT	PU	Contents per PU	Delivery time	Order no. 4004338...
Material: raw steel, Surface: galvanised, thick-film passivated, with attached staple											
400 mm	160 mm	52 mm	18	30 mm	57 mm	120	5	Piece	-	L	124656
600 mm	210 mm	52 mm	18	30 mm	57 mm	320	5	Piece	-	L	124663

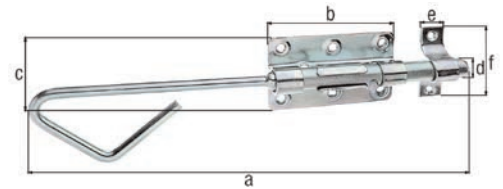

Tower drop bolt

with countersunk screw holes

with reinforced screw holes

Extension length: 50 mm

Dimension a	Dimension b	Dimension c	Dimension d-Ø	Dimension e	Dimension f	Extension length	UNIT	PU	Contents per PU	Delivery time	Order no. 4004338...
Material: raw steel, Surface: galvanised, thick-film passivated, type: straight, with attached staple											
320 mm	100 mm	60 mm	16.0 mm	20 mm	58 mm	50	6	Piece	-	L	129149
Material: raw steel, Surface: galvanised, thick-film passivated, with attached staple											
400 mm	100 mm	60 mm	16.0 mm	20 mm	58 mm	50	6	Piece	-	L	129156
Material: stainless steel, with attached staple											
320 mm	100 mm	65 mm	15.5 mm	20 mm	60 mm	50	4	Piece	-	L	327057 VA

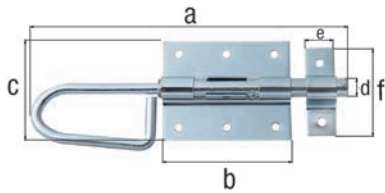

Tower drop bolt

Dimension a	Dimension b	Dimension c	Dimension d-Ø	Dimension e	Dimension f	Extension length	UNIT	PU	Contents per PU	Delivery time	Order no. 4004338...
Material: raw steel, Surface: blue galvanised, with attached staple											
200 mm	80 mm	66 mm	11.5	18 mm	56 mm	33 mm	10	Piece	-	L	137229
300 mm	90 mm	67 mm	13.5	18 mm	61 mm	41 mm	10	Piece	-	L	137243
400 mm	90 mm	67 mm	13.5	18 mm	61 mm	41 mm	10	Piece	-	L	137250
500 mm	95 mm	67 mm	15.5	18 mm	67 mm	42 mm	10	Piece	-	L	137274
Material: raw steel, Surface: blue galvanised, black powder-coated, with fixed staple											
200 mm	80 mm	66 mm	11.5	18 mm	56 mm	34 mm	10	Piece	-	L	137113
300 mm	90 mm	67 mm	13.5	18 mm	61 mm	41 mm	10	Piece	-	L	137151
400 mm	90 mm	67 mm	13.5	18 mm	61 mm	41 mm	10	Piece	-	L	137168
500 mm	95 mm	67 mm	15.5	18 mm	67 mm	41 mm	10	Piece	-	L	137199

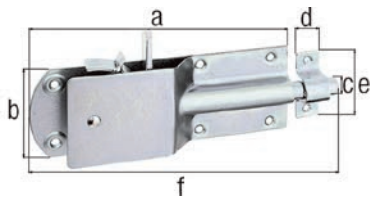

Security barn padlock bolt

with countersunk screw holes

with broad, flat handle
completely hidden catch
Extension length: 50 mm

Dimension a	Dimension b	Dimension c-Ø	Dimension d	Dimension e	Dimension f	UNIT	PU	Contents per PU	Delivery time	Order no. 4004338...
Material: raw steel, Surface: galvanised, thick-film passivated, with attached staple										
200 mm	70 mm	15 mm	20 mm	57 mm	250 mm	5	Piece	-	L	124182
Material: raw steel, Surface: blue galvanised, with attached staple										
200 mm	70 mm	15 mm	20 mm	57 mm	250 mm	5	Piece	-	L	124151

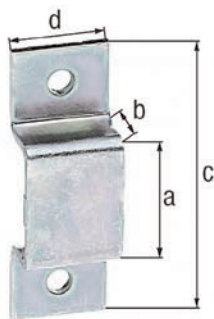

Staple

with countersunk screw holes

Dimension a	Dimension b	Dimension c	Dimension d	UNIT	PU	Contents per PU	Delivery time	Order no. 4004338...
Material: raw steel, Surface: galvanised, thick-film passivated								
7 mm	5 mm	25 mm	8 mm	25	Piece	-	L	132705
15 mm	7 mm	38 mm	13 mm	10	Card	4 Piece	L	901905
20 mm	9 mm	44 mm	13 mm	10	Card	4 Piece	L	901912
25 mm	12 mm	55 mm	16 mm	10	Card	2 Piece	L	901929
29 mm	14 mm	73 mm	20 mm	10	Card	2 Piece	L	901936
Material: raw steel, Surface: galvanised, thick-film passivated, with countersunk screw holes								
20 mm	9 mm	44 mm	13 mm	100	Piece	-	L	122294

Staple

Dimension a	Dimension b	Dimension c	Dimension d	UNIT	PU	Contents per PU	Delivery time	Order no. 4004338...
Material: raw steel, Surface: blue galvanised								
11 mm	16 mm	54 mm	16 mm	20	Piece	-	L	137380
15 mm	20 mm	60 mm	18 mm	20	Piece	-	L	137397
18 mm	23 mm	69 mm	18 mm	20	Piece	-	L	137403
Material: raw steel, Surface: blue galvanised, black powder-coated								
11 mm	16 mm	54 mm	16 mm	20	Piece	-	L	137359
15 mm	20 mm	60 mm	18 mm	20	Piece	-	L	137366
18 mm	23 mm	69 mm	18 mm	20	Piece	-	L	137373

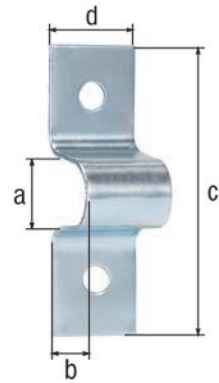

Staple

with countersunk screw holes

Dimension a	Dimension b	Dimension c	Dimension d	UNIT	PU	Contents per PU	Delivery time	Order no. 4004338...
Material: raw steel, Surface: galvanised, thick-film passivated, with countersunk screw holes								
9 mm	12 mm	37 mm	10 mm	50	Piece	-	L	133566
13 mm	16 mm	52 mm	13 mm	6	Card	4 Piece	L	901851
18 mm	24 mm	58 mm	20 mm	5	Card	2 Piece	L	901868

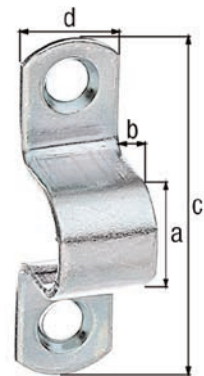

Latch fastener on plate

with countersunk screw holes

Dimension a	Dimension b	Dimension c	UNIT	PU	Contents per PU	Delivery time	Order no. 4004338...
Material: raw steel, Surface: galvanised, thick-film passivated							
45 mm	20 mm	4.5 mm	20	Piece	-	L	136000

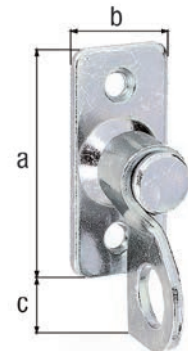

Latch fastener

with strike sheet and spacer

Dimension a-Ø	Dimension b	Dimension c	Dimension d	UNIT	PU	Contents per PU	Delivery time	Order no. 4004338...
Material: die-cast zinc								
10 mm	60 mm	40.3 mm	5 mm	10	Card	2 Piece	L	903664

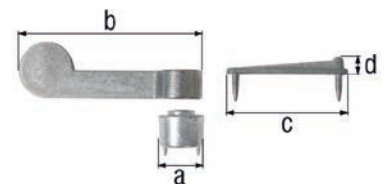

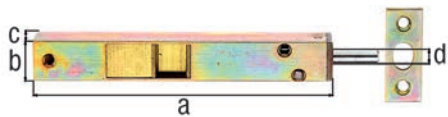

Flush bolt with slider

Dimension a	Dimension b	Dimension c	Dimension d-Ø	UNIT	PU	Contents per PU	Deliv-ery time	Order no. 4004338...
Material: raw steel, Surface: limba-coloured with hammer finish, with locking plate								
160 mm	17 mm	12 mm	7.5 mm	10	Piece	-	L	126100
Material: raw steel, Surface: silver painted, with locking plate								
200 mm	17 mm	12 mm	7.5 mm	10	Piece	-	L	126148

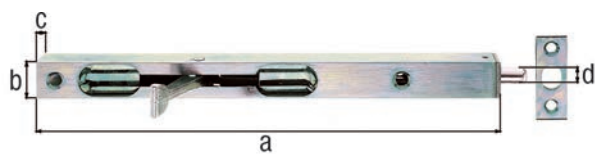

Flush bolt with lever

Dimension a	Dimension b	Dimension c	Dimension d-Ø	UNIT	PU	Contents per PU	Deliv-ery time	Order no. 4004338...
Material: raw steel, Surface: silver painted, with locking plate								
200 mm	17 mm	15 mm	7.5 mm	10	Piece	-	L	126230
220 mm	20 mm	15 mm	10.0 mm	10	Piece	-	L	126353
250 mm	17 mm	15 mm	7.5 mm	10	Piece	-	L	126247
250 mm	20 mm	15 mm	10.0 mm	10	Piece	-	L	126360

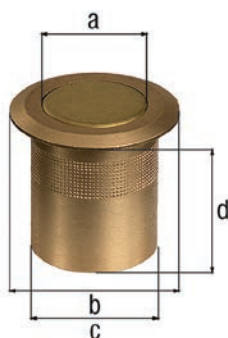

Spring bushing for bolt with round bar

Dimension a-Ø	Dimension b-Ø	Dimension c-Ø	Dimension d	UNIT	PU	Contents per PU	Deliv-ery time	Order no. 4004338...
Material: brass, for countersinking								
10 mm	20 mm	14 mm	28.0 mm	20	Piece	-	L	121501

WOOD CONNECTORS

Made to last.

DECLARATION OF PERFORMANCE

Number: GAH/LE-001
 as required by (EU) regulation 305/2011 - Nr. GAH 6181

1. ETA 08/0171
 GAH joist hangers, type A 1.5 mm and 2 mm and type B
2. Joist hangers type A 2.0 mm construction forms, 320 mm, 380 mm, 440 mm, 500 mm
 Joist hangers type A 1.5 mm construction forms, 260 mm, 320 mm, 380 mm
 Joist hangers type B 2.0 mm construction forms, 238 mm, 260 mm, 320 mm B1, 320 mm, 380 mm, 440 mm, 500 mm
 The joist hangers are labelled with the manufacturer's trade mark, CE marking and the number issued by the Karlsruhe Institute of Technology. All other information, such as the date of manufacture, is specified on the packaging label.
3. The joist hangers are designed for connecting load-bearing wooden components, e.g., for joining wood to wood, wood to concrete or wood to steel; type B is only for joining wood to wood.
4. Gust. Alberts GmbH & Co. KG
 Blumenthal 2
 58849 Herscheid
5. N/A
6. System for assessing constancy of performance: 2+
7. N/A
8. The Karlsruhe Institute of Technology (KIT), NB no. 0769, performed an initial inspection of the plant and factory production control as well as ongoing monitoring, assessment and evaluation of factory production control in accordance with system 2+ and issued the following document: Certificate of conformity for factory production control, no. 0769-CPR-6181.

9. Declared performance:

Essential characteristics	Performance	Standardised technical specification
Characteristic load-bearing capacity	See Annex B of ETA 08/0171	
Stiffness	No performance determined	
Ductility	No performance determined	EN 1350-1
Safety in the event of a fire Fire performance	The joist hangers are made of steel, classified as Euroclass A1 in accordance with EN 1350-1	
Hygiene, health and environmental protection	No hazardous substances contained	
Durability and fitness for purpose	The durability and fitness for purpose of the joist hangers was assessed as satisfactory, provided they are used in timber constructions with wood types described in Eurocode 5, and meet the requirements of service classes 1, 2 and service class 3 for stainless steel.	
Sustainable utilisation of natural resources	No performance determined	
Identification	See appendix A of ETA 08/0171	

ETA 08/0171
 ETAG 015 three-dimensional spike plates

10. The product performance as per numbers 1 and 2 corresponds to the declared performance as per number 9. The manufacturer as stated in number 4 is solely responsible for the issuing of this declaration of performance in compliance with the Regulation (EU) No. 305/2011. Signed for and in the name of the manufacturer by:

Peter Feldmann	Head of Quality Management
_____ Name	_____ Role
Herscheid 22. May 2018	i.A. 
_____ Location and date of issue	_____ Signature

DECLARATION OF PERFORMANCE

Number: GAH/LE-003

as required by (EU) regulation 305/2011 – Nr. GAH 6107

1. DIN EN14545:2009-2
GAH Perforated sheets
2. Type 8600, 8602, 8604, 8605, 8606, 8609, 8610, 8611, 8640, 8642, 8643, 8719, 8719 LO, 8720, 8720 LO, 8721, 8721 LO, 8724, 8725, 8726, 8727, 8728, 8729, 8739, 8740, 8741, 8742, 8743, 8744, 8745, 8746, 8747, 8748, 8749, 8750, 8751, 8752, 8753, 8754, 8755, 8756, 8757.
3. The perforated sheets are labelled with the manufacturer's trade mark, CE marking and the number issued by the Karlsruhe Institute of Technology. All other information, such as the date of manufacture, is specified on the packaging label.
4. The perforated sheets are designed for joining load-bearing wooden components, in sheet thicknesses of 2.0 mm, 2.5 mm and 3 mm.
5. Gust. Alberts GmbH & Co. KG
Blumenthal 2
58849 Herscheid
6. N/A
7. System for assessing constancy of performance: 2+
8. N/A
9. The Karlsruhe Institute of Technology (KIT), NB no. 0769, performed an initial inspection of the plant and factory production control as well as ongoing monitoring, assessment and evaluation of factory production control in accordance with system 2+ and issued the following document: Certificate of conformity for factory production control, no. 0769-CPR-6107.

10. Declared performance

Essential characteristics	Performance	Standardised technical specification
Characteristic load-bearing capacity	DIN EN 14545:2009-02 6.3.1	EN 1995 1.1
Safety in the event of a fire Fire performance	The perforated sheets are made of steel, classified as Euroclass A1 in accordance with EN 1350-1	EN 1350-1
Steel grade	DX 51D Z 275 1.4016, 1.4301, 1.4401, 1.4541, 1.4571	EN 10346: 2009 EN 10088-2:2005
Mechanical values	$R_{eH} \geq 250\text{MPa}$, $R_m \geq 270\text{MPa}$, $A_0 \geq 22\%$	
Protection against corrosion	Usage class 1/2/3	EN 1995:2013
Durability and fitness for purpose	The perforated sheets comply with DIN EN 14545: 2009-2, for use in timber constructions with the wood types described in Eurocode 5 and meet the requirements of service classes 1, 2 and service class 3 for stainless steel.	

DIN EN 14545:2009-2

11. The product performance as per numbers 1 and 2 corresponds to the declared performance as per number 9. The manufacturer as stated in number 4 is solely responsible for the issuing of this declaration of performance in compliance with the Regulation (EU) No. 305/2011. Signed for and in the name of the manufacturer by:

Peter Feldmann

Name

Head of Quality Management

Role

Herscheid 22. May 2019

Location and date of issue

i.A.

Signature

DECLARATION OF PERFORMANCE

Number: GAH/LE-006

as required by (EU) regulation 305/2011 – Nr. GAH 6123

1. ETA 08/0165
GAH Angle connectors
2. Type: 8573, 8590, 8591, 8592, 8593, 8594, 8595, 8596, 8597, 8612, 8613, 8614, 8615, 8617, 8620, 8621, 8623, 8624, 8625, 8625 FH, 8626, 8626 FH, 8627, 8632 FH, 8633 FH, 8634, 8635, 8636, 8637, 8638, 8640, 8641, 8644, 8645, 8622, 8628, 8629, 8632, 8633, 8654, 8655, 8791, 8792, 8793, 8794, 8795, 8799.
The angle connectors are labelled with the manufacturer's trade mark, CE marking and the number issued by the Karlsruhe Institute of Technology. All other information, such as the date of manufacture, is specified on the packaging label.
3. Angle connectors are designed for joining load-bearing wooden components, e.g., for joining a timber beam and a purlin.
4. Gust. Alberts GmbH & Co. KG
Blumenthal 2
58849 Herscheid
5. N/A
6. System for assessing constancy of performance: 2+
7. N/A
8. The Karlsruhe Institute of Technology (KIT), NB no. 0769, performed an initial inspection of the plant and factory production control as well as ongoing monitoring, assessment and evaluation of factory production control in accordance with system 2+ and issued the following document: Certificate of conformity for factory production control, no. 0769-CPR-6123.

9. Declared performance

Essential characteristics	Performance	Standardised technical specification
Characteristic load-bearing capacity	See Annex B of ETA 08/0165	
Stiffness	No performance determined	
Ductility	No performance determined	EN 1350-1
Safety in the event of a fire Fire performance	The angle connectors are made of steel, classified as Euroclass A1 in accordance with EN 1350-1	
hygiene, health and environmental protection	No hazardous substances contained	
Durability and fitness for purpose	The durability and fitness for purpose of the angle connectors was assessed as satisfactory, provided they are used in timber constructions with wood types described in Eurocode 5, and meet the requirements of service classes 1, 2 and service class 3 for stainless steel.	
Sustainable utilisation of natural resources	No performance determined	
Identification	See Annex A of ETA 08/0165	

ETA 08/0165
ETAG 015 three-dimensional spike plates

10. The product performance as per numbers 1 and 2 corresponds to the declared performance as per number 9. The manufacturer as stated in number 4 is solely responsible for the issuing of this declaration of performance in compliance with the Regulation (EU) No. 305/2011. Signed for and in the name of the manufacturer by:

Peter Feldmann

Head of Quality Management

Name

Role

Herscheid 11. February 2019

i.A.



Location and date of issue

Signature

DECLARATION OF PERFORMANCE

Number: GAH/LE-005

as required by (EU) regulation 305/2011 – Nr. GAH 6008

1. ETA 08/0170
GAH Rafter purlin anchors
2. Type: 8646/ 8647 170 right/left, 8648/ 8649 210 right/left
8650/ 8651 250, 290, 330, 370 right/left
The rafter purlin anchors are labelled with the manufacturer's trade mark, CE marking and the number issued by the Karlsruhe Institute of Technology. All other information, such as the date of manufacture, is specified on the packaging label.
3. Rafter purlin anchors are designed for joining load-bearing wooden components, e.g., for joining a timber beam and a purlin.
4. Gust. Alberts GmbH & Co. KG
Blumenthal 2
58849 Herscheid
5. N/A
6. System for assessing constancy of performance: 2+
7. N/A
8. The Karlsruhe Institute of Technology (KIT), NB no. 0769, performed an initial inspection of the plant and factory production control as well as ongoing monitoring, assessment and evaluation of factory production control in accordance with system 2+ and issued the following document: Certificate of conformity for factory production control, no. 0769-CPD-6008.

9. Declared performance

Essential characteristics	Performance	Standardised technical specification
Characteristic load-bearing capacity	See Annex B of ETA 08/0170	
Stiffness	No performance determined	
Ductility	No performance determined	EN 1350-1
Safety in the event of a fire Fire performance	The rafter purlin anchors are made of steel, classified as Euroclass A1 in accordance with EN 1350-1	
Hygiene, health and environmental protection	No hazardous substances contained	
Durability and fitness for purpose	The durability and fitness for purpose of the rafter purlin anchors was assessed as satisfactory, provided they are used in timber constructions with the wood types described in Eurocode 5, and meet the requirements of service classes 1, 2 and service class 3 for stainless steel.	
Identification	See appendix A of ETA 08/0170	

ETA 08/0170
ETAG 015 three-dimensional spike plates

10. The product performance as per numbers 1 and 2 corresponds to the declared performance as per number 9. The manufacturer as stated in number 4 is solely responsible for the issuing of this declaration of performance in compliance with the Regulation (EU) No. 305/2011. Signed for and in the name of the manufacturer by:

Peter Feldmann

Name

Head of Quality Management

Role

Herscheid 22. May 2018

Location and date of issue

i.A.

Signature

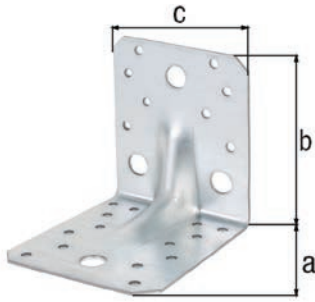

Heavy-duty angle bracket, reinforced

	Dimension a	Dimension b	Dimension c	Material thickness	UNIT	PU	Contents per PU	Delivery time	Order no. 4004338...
Material: raw steel, Surface: sendzimir galvanised, with CE marking in accordance with ETA-08/0165									
CE	50 mm	90 mm	50 mm	2.50 mm	50	Piece	-	L	334666
CE	70 mm	70 mm	55 mm	2.50 mm	50	Piece	-	L	330354
GP	70 mm	70 mm	55 mm	2.50 mm	4	Pack	12 Piece	L	330330
CE	90 mm	90 mm	65 mm	2.50 mm	25	Piece	-	L	330552
GP	90 mm	90 mm	65 mm	2.50 mm	4	Pack	12 Piece	L	330514
CE	105 mm	105 mm	90 mm	3.00 mm	20	Piece	-	L	330606
GP	105 mm	105 mm	90 mm	3.00 mm	2	Pack	12 Piece	L	330521
Material: raw steel, Surface: galvanised, white powder-coated, with CE marking in accordance with ETA-08/0165									
CE	70 mm	70 mm	55 mm	2.50 mm	50	Piece	-	L	330378
CE	90 mm	90 mm	65 mm	2.50 mm	25	Piece	-	L	330576
Material: stainless steel									
VA	70 mm	70 mm	55 mm	2.00 mm	25	Piece	-	L	335212
VA	90 mm	90 mm	65 mm	2.00 mm	10	Piece	-	L	335250
VA	105 mm	105 mm	90 mm	2.50 mm	25	Piece	-	L	335267

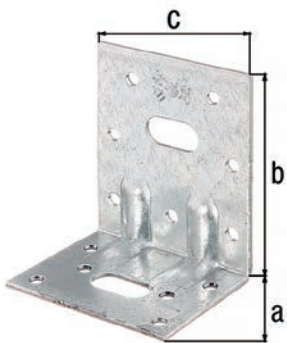

Heavy-duty angle bracket, reinforced

Material thickness: 2.00 mm

	Dimension a	Dimension b	Dimension c	UNIT	PU	Contents per PU	Delivery time	Order no. 4004338...
Material: raw steel, Surface: sendzimir galvanised, with CE marking in accordance with ETA-08/0165								
CE	50 mm	77 mm	64 mm	50	Piece	-	L	335717

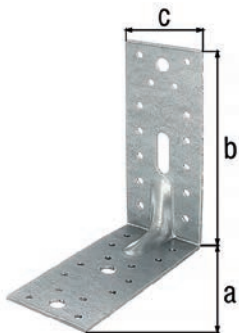

Heavy-duty angle bracket, reinforced

Material thickness: 2.50 mm

	Dimension a	Dimension b	Dimension c	UNIT	PU	Contents per PU	Delivery time	Order no. 4004338...
Material: raw steel, Surface: sendzimir galvanised, with CE marking in accordance with ETA-08/0165								
CE	150 mm	150 mm	65 mm	25	Piece	-	L	335724

Heavy-duty angle bracket, reinforced

Material thickness: 2.50 mm

Dimension a	Dimension b	Dimension c	UNIT	PU	Contents per PU	Deliv-ery time	Order no. 4004338...
Material: raw steel, Surface: sendzimir galvanised							
125 mm	125 mm	45 mm	50	Piece	-	L	336615

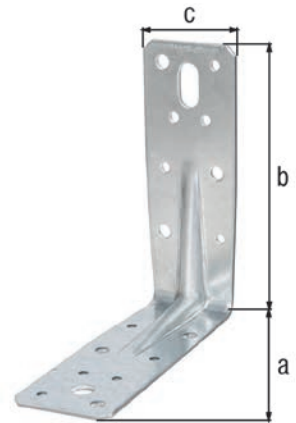

Angle bracket, reinforced with fixing claw for driving in

Material thickness: 2.00 mm

- Angle bracket with extended claw fastener that holds the connector securely to the wood after it is driven in and so allows the unit to be screwed together easily.

Dimension a	Dimension b	Dimension c	UNIT	PU	Contents per PU	Deliv-ery time	Order no. 4004338...
Material: raw steel, Surface: sendzimir galvanised							
70 mm	70 mm	55 mm	25	Piece	-	L	339807
90 mm	90 mm	65 mm	25	Piece	-	L	339814

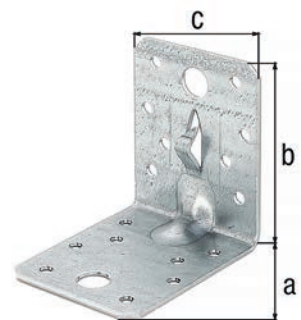

Angle bracket KR

Material thickness: 4.00 mm

Dimension a	Dimension b	Dimension c	UNIT	PU	Contents per PU	Deliv-ery time	Order no. 4004338...
Material: raw steel, Surface: hot-dip galvanised, with CE marking in accordance with ETA-08/0165							
95 mm	85 mm	65 mm	20	Piece	-	L	330934 CE
135 mm	85 mm	65 mm	20	Piece	-	L	330910 CE
285 mm	85 mm	65 mm	10	Piece	-	L	330927 CE

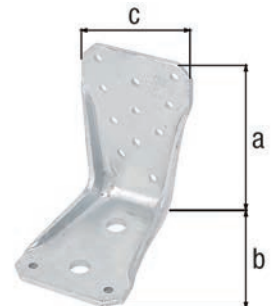

Angle bracket KR

Material thickness: 4.00 mm

Dimension a	Dimension b	Dimension c	UNIT	PU	Contents per PU	Deliv-ery time	Order no. 4004338...
Material: raw steel, Surface: hot-dip galvanised, with CE marking in accordance with ETA-08/0165							
95 mm	85 mm	65 mm	25	Piece	-	L	330842 CE
135 mm	85 mm	65 mm	25	Piece	-	L	330897 CE
285 mm	85 mm	65 mm	12	Piece	-	L	330996 CE

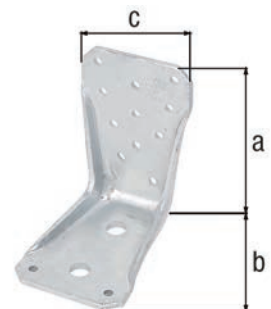

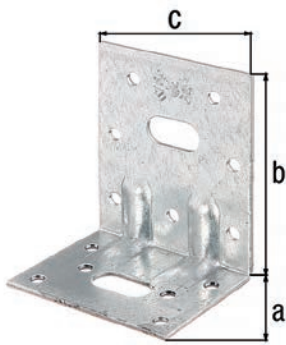

Heavy-duty angle bracket, reinforced

Material thickness: 2.50 mm

Dimension a	Dimension b	Dimension c	UNIT	PU	Contents per PU	Deliv-ery time	Order no. 4004338...
Material: raw steel, Surface: sendzimir galvanised, with CE marking in accordance with ETA-08/0165							
50 mm	90 mm	80 mm	50	Piece	-	L	334659

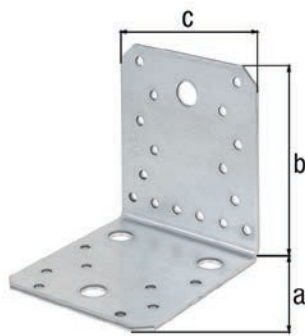

Angle bracket

Dimension a	Dimension b	Dimension c	Material thickness	UNIT	PU	Contents per PU	Deliv-ery time	Order no. 4004338...
Material: raw steel, Surface: sendzimir galvanised								
40 mm	40 mm	20 mm	2.00 mm	100	Piece	-	L	330156
40 mm	40 mm	20 mm	2.00 mm	12	Pack	25 Piece	L	330187
40 mm	40 mm	40 mm	2.00 mm	50	Piece	-	L	330200
40 mm	40 mm	40 mm	2.00 mm	6	Pack	25 Piece	L	330194
Material: raw steel, Surface: sendzimir galvanised, with CE marking in accordance with ETA-08/0165								
50 mm	50 mm	35 mm	2.50 mm	50	Piece	-	L	330309
50 mm	50 mm	35 mm	2.50 mm	10	Pack	6 Piece	L	332334
50 mm	50 mm	35 mm	2.50 mm	6	Pack	25 Piece	L	330323
50 mm	50 mm	40 mm	2.00 mm	50	Piece	-	L	330255
50 mm	50 mm	40 mm	2.00 mm	6	Pack	25 Piece	L	330316
80 mm	80 mm	40 mm	2.00 mm	50	Piece	-	L	330644
90 mm	90 mm	40 mm	3.00 mm	50	Piece	-	L	330408
90 mm	90 mm	40 mm	3.00 mm	10	Pack	6 Piece	L	332914
100 mm	100 mm	40 mm	2.00 mm	50	Piece	-	L	353216
60 mm	60 mm	45 mm	2.50 mm	50	Piece	-	L	330835
70 mm	70 mm	55 mm	2.50 mm	50	Piece	-	L	339630
70 mm	70 mm	55 mm	2.50 mm	10	Pack	6 Piece	L	332938
40 mm	60 mm	60 mm	2.50 mm	10	Pack	6 Piece	L	332525
40 mm	60 mm	60 mm	2.50 mm	50	Piece	-	L	334369
60 mm	80 mm	60 mm	2.50 mm	10	Pack	6 Piece	L	332976
60 mm	80 mm	60 mm	2.50 mm	50	Piece	-	L	334352
100 mm	60 mm	60 mm	2.50 mm	50	Piece	-	L	330149
90 mm	90 mm	65 mm	2.50 mm	25	Piece	-	L	330453
90 mm	90 mm	65 mm	2.50 mm	6	Pack	6 Piece	L	333614
105 mm	105 mm	90 mm	3.00 mm	25	Piece	-	L	330507
Material: raw steel, Surface: galvanised, black powder-coated								
40 mm	40 mm	40 mm	2.00 mm	50	Piece	-	L	327309
70 mm	70 mm	55 mm	-	20	Piece	-	L	332693
Material: raw steel, Surface: galvanised, white powder-coated								
40 mm	40 mm	40 mm	2.00 mm	50	Piece	-	L	330224
Material: raw steel, Surface: galvanised, white powder-coated, with CE marking in accordance with ETA-08/0165								
50 mm	50 mm	40 mm	2.00 mm	50	Piece	-	L	330286
Material: stainless steel								
40 mm	40 mm	40 mm	2.00 mm	25	Piece	-	L	361020
50 mm	50 mm	40 mm	2.00 mm	50	Piece	-	L	335205
70 mm	70 mm	55 mm	2.00 mm	20	Piece	-	L	327149

Angle bracket

suitable for corner joints
Material thickness: 2.00 mm

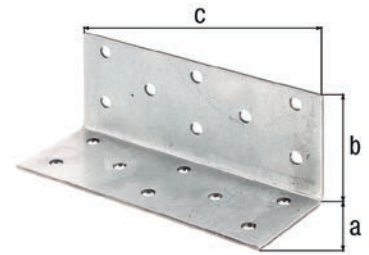

Dimension a	Dimension b	Dimension c	UNIT	PU	Contents per PU	Deliv-ery time	Order no. 4004338...
Material: raw steel, Surface: sendzimir galvanised							
40 mm	40 mm	100 mm	25	Piece	-	L	335755

Angle bracket angled at 135°

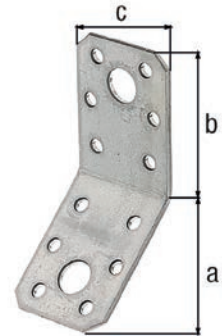

Dimension a	Dimension b	Dimension c	Material thickness	UNIT	PU	Contents per PU	Deliv-ery time	Order no. 4004338...
Material: raw steel, Surface: sendzimir galvanised								
50 mm	50 mm	35 mm	2.50 mm	50	Piece	-	L	335502
90 mm	90 mm	40 mm	3.00 mm	50	Piece	-	L	335557
90 mm	90 mm	65 mm	2.50 mm	25	Piece	-	L	335601

Perforated angle plate

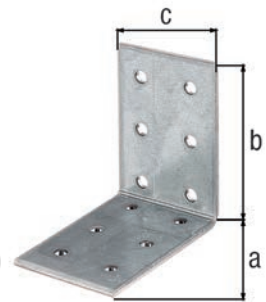

Dimension a	Dimension b	Dimension c	Material thickness	UNIT	PU	Contents per PU	Deliv-ery time	Order no. 4004338...
Material: raw steel, Surface: sendzimir galvanised, with CE marking in accordance with ETA-08/0165								
60 mm	60 mm	40 mm	2.50 mm	50	Piece	-	L	330705 CE
60 mm	60 mm	40 mm	2.50 mm	8	Pack	15 Piece	L	330538 BP CE
60 mm	60 mm	50 mm	2.00 mm	50	Piece	-	L	331481 CE
40 mm	40 mm	60 mm	2.50 mm	50	Piece	-	L	330651 CE
40 mm	40 mm	60 mm	2.50 mm	4	Pack	20 Piece	L	339067 BP CE
60 mm	60 mm	60 mm	2.50 mm	50	Piece	-	L	330750 CE
60 mm	60 mm	60 mm	2.50 mm	4	Pack	15 Piece	L	330545 BP CE
80 mm	80 mm	60 mm	2.50 mm	50	Piece	-	L	331498 CE
60 mm	60 mm	80 mm	2.50 mm	25	Piece	-	L	330804 CE
80 mm	80 mm	80 mm	2.50 mm	25	Piece	-	L	330859 CE
100 mm	100 mm	80 mm	2.50 mm	25	Piece	-	L	332068 CE
100 mm	100 mm	100 mm	2.50 mm	25	Piece	-	L	330903 CE
Material: raw steel, Surface: galvanised, black powder-coated								
60 mm	60 mm	60 mm	2.50 mm	25	Piece	-	L	337582
Material: raw steel, Surface: galvanised, white powder-coated, with CE marking in accordance with ETA-08/0165								
60 mm	60 mm	60 mm	2.50 mm	50	Piece	-	L	330774 CE
Material: stainless steel								
60 mm	60 mm	40 mm	2.00 mm	10	Piece	-	L	361044 VA
40 mm	40 mm	60 mm	2.00 mm	25	Piece	-	L	361037 VA
60 mm	60 mm	60 mm	2.00 mm	25	Piece	-	L	335311 VA

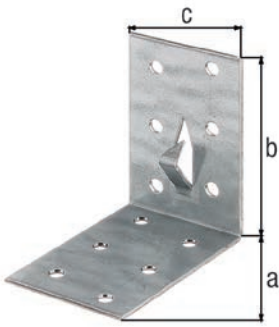

Perforated angle plate with fixing claw for driving in

Material thickness: 1.50 mm

- Perforated plate angle connector with extended claw fastener that holds the connector securely to the wood after it is driven in and so allows the unit to be screwed together easily.

Dimension a	Dimension b	Dimension c	UNIT	PU	Contents per PU	Deliv-ery time	Order no. 4004338...
Material: raw steel, Surface: sendzimir galvanised							
60 mm	60 mm	40 mm	25	Piece	-	L	339821
60 mm	60 mm	60 mm	25	Piece	-	L	339838

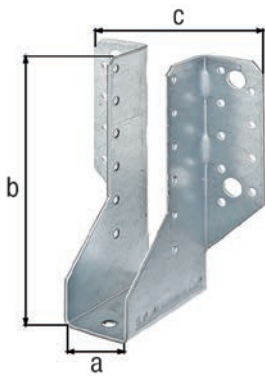

Joist hanger Type A

	Dimension a	Dimension b	Dimension c	Material thickness	UNIT	PU	Contents per PU	Deliv-ery time	Order no. 4004338...
Material: raw steel, Surface: sendzimir galvanised, with CE marking in accordance with ETA-08/0171									
CE	34 mm	143 mm	104 mm	2.00 mm	25	Piece	-	L	335335
CE	40 mm	110 mm	110 mm	2.00 mm	25	Piece	-	L	334505
CE	45 mm	110 mm	115 mm	2.00 mm	25	Piece	-	L	335984
CE	40 mm	140 mm	110 mm	2.00 mm	25	Piece	-	L	353773
CE	50 mm	68 mm	120 mm	2.00 mm	25	Piece	-	L	353780
CE	50 mm	105 mm	120 mm	2.00 mm	25	Piece	-	L	334512
CE	50 mm	135 mm	120 mm	2.00 mm	25	Piece	-	L	335120
CE	60 mm	80 mm	130 mm	2.00 mm	25	Piece	-	L	354947
CE	60 mm	100 mm	138 mm	2.00 mm	25	Piece	-	L	331252
GP	60 mm	100 mm	138 mm	2.00 mm	6	Pack	6 Piece	L	331375
CE	60 mm	130 mm	130 mm	2.00 mm	25	Piece	-	L	353797
CE	60 mm	160 mm	130 mm	2.00 mm	25	Piece	-	L	353162
CE	64 mm	65 mm	134 mm	2.00 mm	25	Piece	-	L	334536
CE	64 mm	98 mm	134 mm	2.00 mm	25	Piece	-	L	334529
CE	64 mm	128 mm	134 mm	2.00 mm	25	Piece	-	L	335144
CE	64 mm	158 mm	134 mm	2.00 mm	25	Piece	-	L	353803
CE	70 mm	95 mm	140 mm	2.00 mm	25	Piece	-	L	333850
CE	70 mm	125 mm	140 mm	2.00 mm	25	Piece	-	L	335151
CE	70 mm	155 mm	140 mm	2.00 mm	25	Piece	-	L	353827
CE	76 mm	90 mm	146 mm	2.00 mm	25	Piece	-	L	335342
CE	76 mm	152 mm	146 mm	2.00 mm	25	Piece	-	L	335168
CE	80 mm	120 mm	150 mm	2.00 mm	25	Piece	-	L	331306
GP	80 mm	120 mm	150 mm	2.00 mm	4	Pack	6 Piece	L	331382
CE	80 mm	150 mm	150 mm	2.00 mm	25	Piece	-	L	335182
CE	80 mm	180 mm	170 mm	2.00 mm	25	Piece	-	L	354725
CE	100 mm	140 mm	170 mm	2.00 mm	25	Piece	-	L	331351
GP	100 mm	140 mm	170 mm	2.00 mm	4	Pack	6 Piece	L	331399
CE	100 mm	200 mm	190 mm	2.00 mm	25	Piece	-	L	335243
CE	120 mm	160 mm	210 mm	2.00 mm	10	Piece	-	L	331405
CE	120 mm	190 mm	210 mm	2.00 mm	10	Piece	-	L	354770
CE	140 mm	180 mm	228 mm	2.00 mm	10	Piece	-	L	331450
Material: raw steel, Surface: sendzimir galvanised, with CE marking in accordance with ETA-09/0021									
CE	160 mm	200 mm	240 mm	2.50 mm	10	Piece	-	L	335007
Material: stainless steel, with CE marking in accordance with ETA 08/0171									
CE VA	60 mm	100 mm	130 mm	2.00 mm	25	Piece	-	L	335410
CE VA	80 mm	120 mm	150 mm	2.00 mm	25	Piece	-	L	335427

Joist hanger Type A

Type: two parts
Material thickness: 2.00 mm

Dimension a	Dimension b	Dimension c	UNIT	PU	Contents per PU	Delivery time	Order no. 4004338...
Material: raw steel, Surface: sendzimir galvanised, left							
25 mm	140 mm	40 mm	25	Piece	-	L	331559
Material: raw steel, Surface: sendzimir galvanised, right							
25 mm	140 mm	40 mm	25	Piece	-	L	331504
Material: raw steel, Surface: sendzimir galvanised, left, with CE marking in accordance with ETA-09/0021							
30 mm	100 mm	38 mm	25	Piece	-	L	335649
Material: raw steel, Surface: sendzimir galvanised, right with CE marking in accordance with ETA-09/0021							
30 mm	100 mm	38 mm	25	Piece	-	L	335632

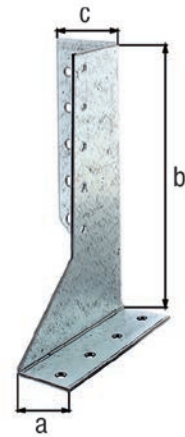
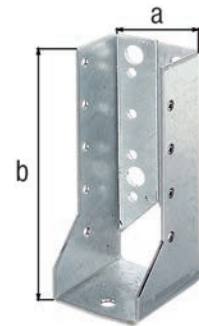

Fig. Version on left

Joist hanger Type B

Material thickness: 2.00 mm

Dimension a	Dimension b	UNIT	PU	Contents per PU	Delivery time	Order no. 4004338...
Material: raw steel, Surface: sendzimir galvanised, with CE marking in accordance with ETA-08/0171						
40 mm	110 mm	25	Piece	-	L	353926
60 mm	100 mm	25	Piece	-	L	353902
64 mm	128 mm	25	Piece	-	L	335229
76 mm	152 mm	25	Piece	-	L	354954
80 mm	120 mm	25	Piece	-	L	335359
100 mm	140 mm	10	Piece	-	L	335403
120 mm	160 mm	10	Piece	-	L	335458



Joist hanger with rounded ends, light

Material thickness: 1.00 mm

Dimension a	Dimension b	Dimension c	UNIT	PU	Contents per PU	Delivery time	Order no. 4004338...
Material: raw steel, Surface: sendzimir galvanised							
25 mm	75 mm	96 mm	50	Piece	-	L	339371
38 mm	70 mm	111 mm	50	Piece	-	L	339456
46 mm	66 mm	120 mm	50	Piece	-	L	336554
51 mm	61 mm	120 mm	50	Piece	-	L	350208
59 mm	69 mm	130 mm	50	Piece	-	L	350222

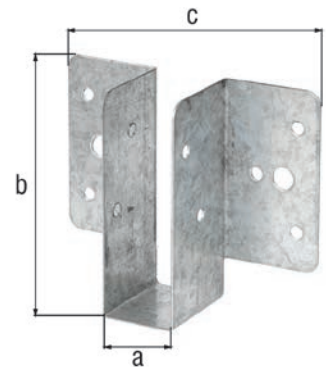

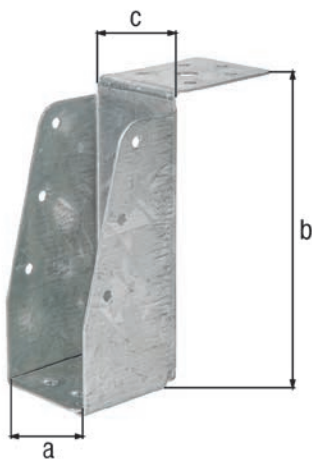

Joist hanger with rounded ends, light, with clip

Dimension a	Dimension b	Dimension c	UNIT	PU	Contents per PU	Deliv-ery time	Order no. 4004338...
Material: raw steel, Surface: sendzimir galvanised							
46 mm	121 mm	50 mm	10	Piece	-	L	338633
59 mm	156 mm	62 mm	10	Piece	-	L	338893
63 mm	175 mm	65 mm	10	Piece	-	L	339012
71 mm	171 mm	75 mm	10	Piece	-	L	338909
Material: raw steel, Surface: blue galvanised							
50 mm	150 mm	55 mm	10	Piece	-	L	332648

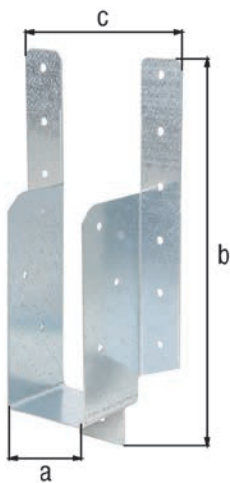

Joist hanger with rounded ends, light, with clip

Material thickness: 1.00 mm

Dimension a	Dimension b	Dimension c	UNIT	PU	Contents per PU	Deliv-ery time	Order no. 4004338...
Material: raw steel, Surface: sendzimir galvanised							
50 mm	190 mm	103 mm	10	Piece	-	L	338794
59 mm	190 mm	114 mm	25	Piece	-	L	338992
Material: raw steel, Surface: blue galvanised							
46 mm	190 mm	105 mm	25	Piece	-	L	332280
71 mm	175 mm	129 mm	25	Piece	-	L	333232

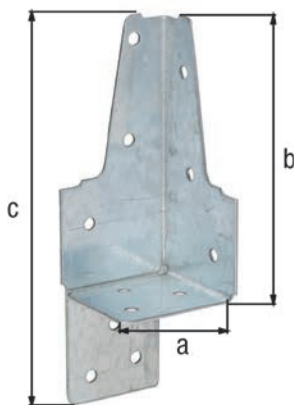

Universal connector

Material thickness: 1.25 mm

Dimension a	Dimension b	Dimension c	Material thickness	UNIT	PU	Contents per PU	Deliv-ery time	Order no. 4004338...
Material: raw steel, Surface: blue galvanised, right								
40 mm	83 mm	125 mm	1.25 mm	50	Piece	-	L	338206
Material: raw steel, Surface: blue galvanised, left								
40 mm	83 mm	125 mm	1.25 mm	50	Piece	-	L	338350

Joist hanger support

Material thickness: 1.50 mm

Dimension a	Dimension b	Dimension c	UNIT	PU	Contents per PU	Deliv-ery time	Order no. 4004338...
Material: raw steel, Surface: sendzimir galvanised							
46 mm	82 mm	112 mm	25	Piece	-	L	350215

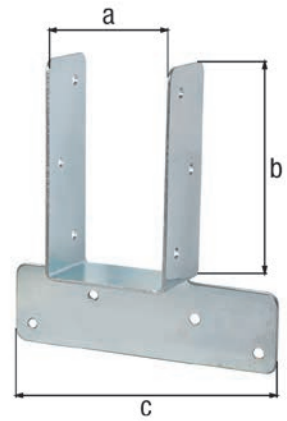

Rafter purlin anchor

Material thickness: 2.00 mm

Dimension a	Dimension b	Dimension c	UNIT	PU	Contents per PU	Deliv-ery time	Order no. 4004338...
Material: raw steel, Surface: sendzimir galvanised, right, with CE marking in accordance with ETA-08/0170							
32 mm	32 mm	170 mm	25	Piece	-	L	330958 CE
32 mm	32 mm	210 mm	25	Piece	-	L	331054 CE
32 mm	32 mm	250 mm	25	Piece	-	L	331153 CE
Material: raw steel, Surface: sendzimir galvanised, left, with CE marking in accordance with ETA-08/0170							
32 mm	32 mm	170 mm	25	Piece	-	L	331009 CE
32 mm	32 mm	210 mm	25	Piece	-	L	331108 CE
32 mm	32 mm	250 mm	25	Piece	-	L	331207 CE
Material: raw steel, Surface: sendzimir galvanised, right and left, with CE marking in accordance with ETA-08/0170							
32 mm	32 mm	170 mm	100	Piece	-	L	334277 CE
32 mm	32 mm	170 mm	4	Pack	12 Piece	L	330941 BP CE
32 mm	32 mm	210 mm	100	Piece	-	L	334284 CE
Material: stainless steel, right, with CE marking in accordance with ETA 08/0170							
32 mm	32 mm	170 mm	25	Piece	-	L	335366 CE VA
Material: stainless steel, left, with CE marking in accordance with ETA 08/0170							
32 mm	32 mm	170 mm	25	Piece	-	L	335373 CE VA

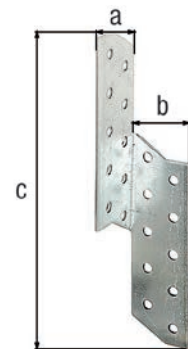

Fig. Version right

Rafter purlin anchor

multifunctional

Material thickness: 2.00 mm

Dimension a	Dimension b	Dimension c	UNIT	PU	Contents per PU	Deliv-ery time	Order no. 4004338...
Material: raw steel, Surface: sendzimir galvanised, with CE marking in accordance with ETA-14/0105							
33 mm	33 mm	170 mm	50	Piece	-	L	338077 CE
33 mm	33 mm	210 mm	50	Piece	-	L	338084 CE
33 mm	33 mm	250 mm	50	Piece	-	L	338091 CE



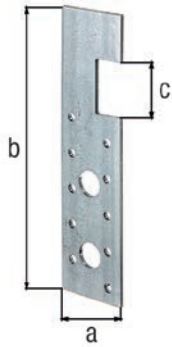

HE post support

Material thickness: 3.00 mm

Dimension a	Dimension b	Dimension c	UNIT	PU	Contents per PU	Deliv-ery time	Order no. 4004338...
Material: raw steel, Surface: sendzimir galvanised							
40 mm	160 mm	30 mm	50	Piece	-	L	338480
55 mm	180 mm	30 mm	50	Piece	-	L	339982

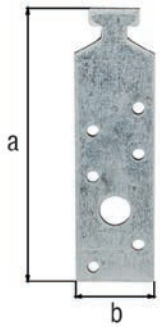

Profile anchor for Halfen channels

Material thickness: 3.00 mm

Dimension a	Dimension b	UNIT	PU	Contents per PU	Deliv-ery time	Order no. 4004338...
Material: raw steel, Surface: sendzimir galvanised, for Halfen channels 28/15, with CE marking in accordance with DIN EN 14545						
CE 160 mm	34 mm	50	Piece	-	L	334468
CE 180 mm	34 mm	50	Piece	-	L	334475
Material: raw steel, Surface: sendzimir galvanised, for Halfen channels 38/17, with CE marking in accordance with DIN EN 14545						
CE 160 mm	34 mm	50	Piece	-	L	334642
CE 180 mm	34 mm	50	Piece	-	L	334499

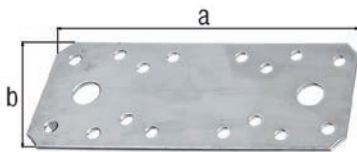

Flat connector

Dimension a	Dimension b	Material thickness	UNIT	PU	Contents per PU	Deliv-ery time	Order no. 4004338...
Material: raw steel, Surface: sendzimir galvanised, with CE marking in accordance with DIN EN 14545							
CE 96 mm	35 mm	2.50 mm	50	Piece	-	L	330002
GP CE 96 mm	35 mm	2.50 mm	6	Pack	25 Piece	L	330088
CE 60 mm	40 mm	2.00 mm	25	Piece	-	L	331412
CE 80 mm	40 mm	2.00 mm	25	Piece	-	L	331429
CE 100 mm	40 mm	2.00 mm	25	Piece	-	L	331436
CE 180 mm	40 mm	3.00 mm	50	Piece	-	L	330101
CE 133 mm	55 mm	2.50 mm	50	Piece	-	L	330057
GP CE 133 mm	55 mm	2.50 mm	4	Pack	15 Piece	L	339050
CE 172 mm	65 mm	2.50 mm	50	Piece	-	L	339753
CE 190 mm	90 mm	3.00 mm	20	Piece	-	L	335700
Material: raw steel, Surface: galvanised, white powder-coated, with CE marking in accordance with DIN EN 14545							
CE 96 mm	35 mm	2.50 mm	50	Piece	-	L	330026
CE 180 mm	40 mm	3.00 mm	50	Piece	-	L	330125
CE 133 mm	55 mm	2.50 mm	50	Piece	-	L	330071
Material: stainless steel							
VA 96 mm	35 mm	2.00 mm	25	Piece	-	L	361006
VA 133 mm	55 mm	2.00 mm	50	Piece	-	L	361013

Flat connector

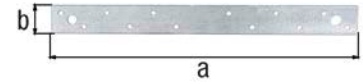

Dimension a	Dimension b	UNIT	PU	Contents per PU	Delivery time	Order no. 4004338...
Material: raw steel, Surface: sendzimir galvanised						
300 mm	32 mm	25	Piece	-	L	336561
400 mm	30 mm	25	Piece	-	L	361693

Flat connector

Material thickness: 0.75 mm

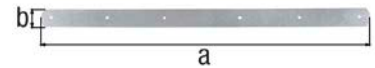

Dimension a	Dimension b	UNIT	PU	Contents per PU	Delivery time	Order no. 4004338...
Material: raw steel, Surface: sendzimir galvanised						
400 mm	22 mm	25	Piece	-	L	336622

Flat connector T shaped

Dimension a	Dimension b	Dimension c	UNIT	PU	Contents per PU	Delivery time	Order no. 4004338...
Material: raw steel, Surface: sendzimir galvanised							
80 mm	106 mm	38 mm	20	Piece	-	L	340513
160 mm	142 mm	45 mm	20	Piece	-	L	353322

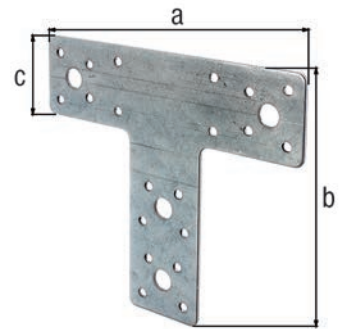

Flat connector T shaped

with countersunk screw holes

Material thickness: 2.00 mm

Dimension a	Dimension b	Dimension c	UNIT	PU	Contents per PU	Delivery time	Order no. 4004338...
Material: raw steel, Surface: sendzimir galvanised							
70 mm	50 mm	16 mm	50	Piece	-	L	333003
140 mm	110 mm	30 mm	25	Piece	-	L	335052

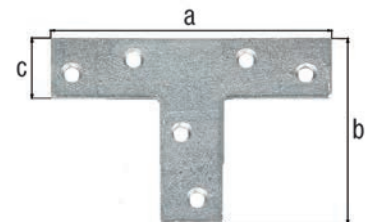

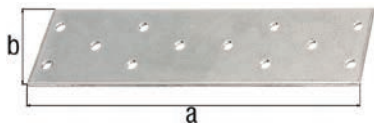

Perforated plate

Material thickness: 2.00 mm

	Dimension a	Dimension b	UNIT	PU	Contents per PU	Deliv-ery time	Order no. 4004338...
Material: raw steel, Surface: sendzimir galvanised, with CE marking in accordance with DIN EN 14545							
CE	115 mm	40 mm	50	Piece	-	L	334451
CE	155 mm	40 mm	50	Piece	-	L	337704
CE	140 mm	60 mm	50	Piece	-	L	331467
CE	200 mm	60 mm	25	Piece	-	L	331955
GP CE	200 mm	60 mm	4	Pack	12 Piece	L	339074
CE	240 mm	60 mm	25	Piece	-	L	331962
CE	200 mm	80 mm	25	Piece	-	L	331993
CE	240 mm	80 mm	25	Piece	-	L	332006
CE	300 mm	80 mm	25	Piece	-	L	331474
CE	200 mm	100 mm	25	Piece	-	L	332020
CE	300 mm	100 mm	20	Piece	-	L	332037
CE	240 mm	120 mm	25	Piece	-	L	333782
	240 mm	120 mm	20	Piece	-	L	333881
CE	300 mm	120 mm	25	Piece	-	L	333799
	300 mm	120 mm	20	Piece	-	L	333898

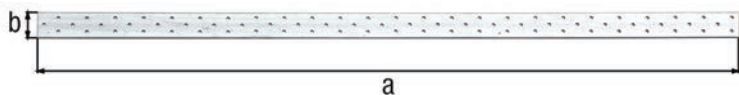

Perforated steel strip

Material thickness: 2.00 mm

	Dimension a	Dimension b	UNIT	PU	Contents per PU	Deliv-ery time	Order no. 4004338...
Material: raw steel, Surface: sendzimir galvanised, with CE marking in accordance with DIN EN 14545							
CE	1000 mm	40 mm	1	Piece	-	L	334956

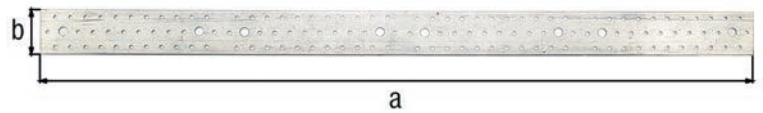

Perforated steel strip

with two suspension holes
Material thickness: 2.00 mm

Dimension a	Dimension b	UNIT	PU	Contents per PU	Deliv-ery time	Order no. 4004338...
Material: raw steel, Surface: sendzimir galvanised, with CE marking in accordance with DIN EN 14545						
960 mm	60 mm	1	Piece	-	L	339401
960 mm	80 mm	1	Piece	-	L	339418
960 mm	100 mm	1	Piece	-	L	339425

Mending plate with spikes

Length of nail: 8 mm
Material thickness: 1.00 mm

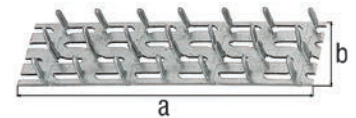

Dimension a	Dimension b	UNIT	PU	Contents per PU	Deliv-ery time	Order no. 4004338...
Material: raw steel, Surface: sendzimir galvanised, for driving in						
102 mm	25 mm	40	Piece	-	L	350161
127 mm	38 mm	30	Piece	-	L	350178

Flat steel anchor

Material thickness: 2.00 mm

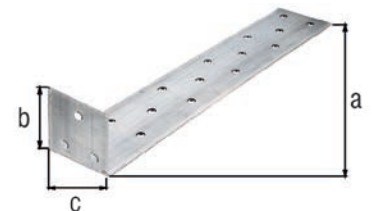

Dimension a	Dimension b	Dimension c	UNIT	PU	Contents per PU	Deliv-ery time	Order no. 4004338...
Material: raw steel, Surface: sendzimir galvanised, for setting in concrete, with CE marking in accordance with ETA-08/0165							
205 mm	40 mm	40 mm	10	Piece	-	L	332105
285 mm	40 mm	40 mm	10	Piece	-	L	332150
400 mm	40 mm	40 mm	10	Piece	-	L	332204
500 mm	40 mm	40 mm	10	Piece	-	L	332075

Builders band



Dimension a	Material thickness	Length	UNIT	PU	Contents per PU	Deliv-ery time	Order no. 4004338...
Material: raw steel, Surface: sendzimir galvanised, with CE marking in accordance with DIN EN 14545							
40 mm	1.50 mm	50 m	1	Piece	-	L	339852
40 mm	2.00 mm	10 m	1	Piece	-	L	339043
40 mm	2.00 mm	50 m	1	Piece	-	L	339036
60 mm	1.50 mm	50 m	1	Piece	-	L	339883
60 mm	2.00 mm	50 m	1	Piece	-	L	339890

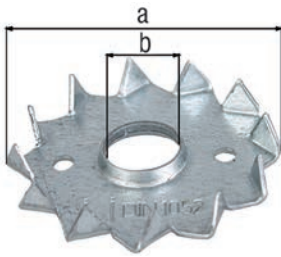

Toothed timber connector

type C2, one-sided with teeth
produced in accordance with EN912 (DIN 1052)

	Dimension a-Ø	Dimension b-Ø	For screw	UNIT	PU	Contents per PU	Deliv-ery time	Order no. 4004338...
Material: raw steel, Surface: sendzimir galvanised, with CE marking in accordance with DIN EN 14545								
CE	48 mm	12 mm	M12	250	Piece	-	L	334413
CE	62 mm	12 mm	M12	100	Piece	-	L	334420
CE	75 mm	16 mm	M16	50	Piece	-	L	337438

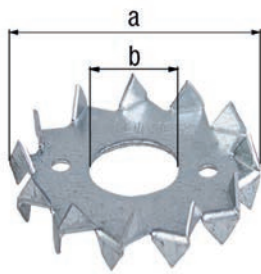

Toothed timber connector

type C1, double-sided with teeth
produced in accordance with EN912 (DIN 1052)

	Dimension a-Ø	Dimension b-Ø	For screw	UNIT	PU	Contents per PU	Deliv-ery time	Order no. 4004338...
Material: raw steel, Surface: sendzimir galvanised, with CE marking in accordance with DIN EN 14545								
CE	48 mm	17 mm	M16	150	Piece	-	L	334437
CE	62 mm	21 mm	M20	50	Piece	-	L	334444
CE	75 mm	26 mm	M24	50	Piece	-	L	338039

Anchor nail

anchor nails are classified as class III load range as per DIN 1052

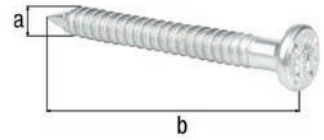

Dimension a-Ø	Dimension b	UNIT	PU	Contents per PU	Deliv-ery time	Order no. 4004338...	
Material: raw steel, Surface: galvanised, in hanging box, with CE marking in accordance with DIN EN 14592							
4.0 mm	40 mm	4	Pack	50 Piece	L	331634	☞ CE
4.0 mm	50 mm	4	Pack	50 Piece	L	331788	☞ CE
Material: raw steel, Surface: galvanised, bargain pack in cardboard box, with CE marking in accordance with DIN EN 14592							
4.0 mm	40 mm	4	Box	250 Piece	L	331610	GP CE
4.0 mm	50 mm	3	Box	250 Piece	L	331764	GP CE
4.0 mm	60 mm	2	Box	250 Piece	L	331917	GP CE

ANGLE BRACKETS, MENDING PLATES

Made to last.

Angle bracket

with countersunk screw holes on both sides

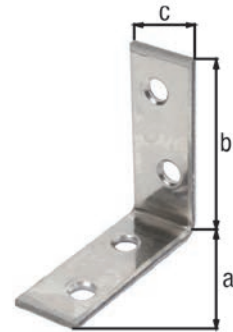

Dimension a	Dimension b	Dimension c	Material thickness	UNIT	PU	Contents per PU	Deliv-ery time	Order no. 4004338...	
Material: raw steel, Surface: sendzimir galvanised									
25 mm	25 mm	14 mm	1.50 mm	100	Piece	-	L	339180	
25 mm	25 mm	14 mm	1.50 mm	10	Pack	12 Piece	L	336066	GP
25 mm	25 mm	14 mm	1.50 mm	10	Pack	50 Piece	L	339463	GP
30 mm	30 mm	14 mm	1.50 mm	100	Piece	-	L	339197	
30 mm	30 mm	14 mm	1.50 mm	10	Pack	12 Piece	L	336011	GP
40 mm	40 mm	15 mm	1.75 mm	100	Piece	-	L	339203	
40 mm	40 mm	15 mm	1.75 mm	10	Pack	12 Piece	L	336165	GP
40 mm	40 mm	15 mm	1.75 mm	10	Pack	50 Piece	L	339470	GP
50 mm	50 mm	15 mm	1.75 mm	100	Piece	-	L	339210	
50 mm	50 mm	15 mm	1.75 mm	10	Pack	12 Piece	L	336219	GP
60 mm	60 mm	16 mm	1.75 mm	100	Piece	-	L	339227	
60 mm	60 mm	16 mm	1.75 mm	10	Pack	8 Piece	L	336264	GP
75 mm	75 mm	16 mm	1.75 mm	50	Piece	-	L	339388	
75 mm	75 mm	16 mm	1.75 mm	10	Pack	8 Piece	L	336288	GP
90 mm	90 mm	19 mm	2.00 mm	50	Piece	-	L	339234	
100 mm	100 mm	19 mm	2.00 mm	40	Piece	-	L	332358	
100 mm	100 mm	19 mm	2.00 mm	10	Pack	20 Piece	L	332396	GP
125 mm	125 mm	22 mm	2.00 mm	40	Piece	-	L	332402	
150 mm	150 mm	25 mm	3.00 mm	20	Piece	-	L	332457	
Material: raw steel, Surface: blue galvanised									
125 mm	125 mm	22 mm	2.00 mm	40	Piece	-	L	336837	
150 mm	150 mm	25 mm	3.00 mm	20	Piece	-	L	336899	
25 mm	25 mm	14 mm	1.50 mm	10	Pack	12 Piece	L	332846	GP
Material: raw steel, Surface: brass-plated									
25 mm	25 mm	14 mm	1.50 mm	10	Card	4 Piece	L	336097	GP
40 mm	40 mm	15 mm	1.75 mm	50	Piece	-	L	336134	
50 mm	50 mm	15 mm	1.75 mm	50	Piece	-	L	336189	
Material: raw steel, Surface: blue galvanised, black powder-coated									
40 mm	40 mm	15 mm	1.75 mm	50	Piece	-	L	332594	
75 mm	75 mm	16 mm	1.75 mm	25	Piece	-	L	333287	
Material: raw steel, Surface: zinc phosphate plated, white powder-coated									
25 mm	25 mm	14 mm	1.50 mm	10	Card	4 Piece	L	336042	GP
40 mm	40 mm	15 mm	1.75 mm	50	Piece	-	L	336660	
40 mm	40 mm	15 mm	1.75 mm	5	Pack	12 Piece	L	336684	GP
60 mm	60 mm	16 mm	1.75 mm	50	Piece	-	L	336714	
60 mm	60 mm	16 mm	1.75 mm	5	Pack	8 Piece	L	336738	GP
Material: stainless steel									
40 mm	40 mm	15 mm	1.75 mm	50	Piece	-	L	361112	VA
60 mm	60 mm	16 mm	2.00 mm	50	Piece	-	L	361129	VA
75 mm	75 mm	16 mm	2.00 mm	25	Piece	-	L	361136	VA
100 mm	100 mm	19 mm	2.00 mm	25	Piece	-	L	361099	VA

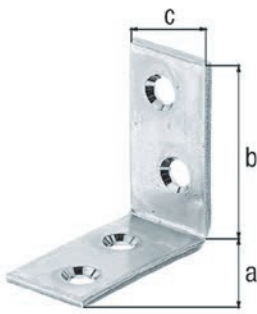

Corner brace

with countersunk screw holes

Material thickness: 2.50 mm

Dimension a	Dimension b	Dimension c	UNIT	PU	Contents per PU	Deliv-ery time	Order no. 4004338...
Material: raw steel, Surface: sendzimir galvanised							
40 mm	40 mm	20 mm	40	Piece	-	L	333034
60 mm	60 mm	20 mm	40	Piece	-	L	333041



Corner brace, reinforced, rounded ends

with countersunk screw holes

Dimension a	Dimension b	Dimension c	Material thickness	UNIT	PU	Contents per PU	Deliv-ery time	Order no. 4004338...
Material: raw steel, Surface: blue galvanised								
20 mm	20 mm	16 mm	1.50 mm	120	Piece	-	L	329860
20 mm	20 mm	16 mm	1.50 mm	20	Collar	4 Piece	L	329808
30 mm	30 mm	16 mm	2.00 mm	120	Piece	-	L	329877
30 mm	30 mm	16 mm	2.00 mm	20	Collar	4 Piece	L	329815
40 mm	40 mm	19 mm	2.00 mm	120	Piece	-	L	329884
40 mm	40 mm	19 mm	2.00 mm	20	Collar	4 Piece	L	329822
60 mm	60 mm	19 mm	2.00 mm	120	Piece	-	L	329891
60 mm	60 mm	19 mm	2.00 mm	20	Collar	4 Piece	L	329839
80 mm	80 mm	19 mm	2.00 mm	50	Piece	-	L	329907
80 mm	80 mm	19 mm	2.00 mm	10	Collar	4 Piece	L	329846
100 mm	100 mm	19 mm	2.00 mm	50	Piece	-	L	329914
100 mm	100 mm	19 mm	2.00 mm	10	Collar	4 Piece	L	329853



Corner brace, rounded ends

with countersunk screw holes

Dimension a	Dimension b	Dimension c	UNIT	PU	Contents per PU	Deliv-ery time	Order no. 4004338...
Material: raw steel, Surface: blue galvanised							
50 mm	50 mm	14 mm	30	Collar	4 Piece	L	338053
50 mm	50 mm	14 mm	100	Piece	-	L	339548

Corner plate

with countersunk screw holes

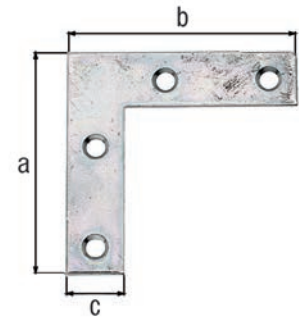

Dimension a	Dimension b	Dimension c	Material thickness	UNIT	PU	Contents per PU	Deliv-ery time	Order no. 4004338...
Material: raw steel, Surface: sendzimir galvanised								
40 mm	40 mm	10 mm	1.25 mm	100	Piece	-	L	336851
40 mm	40 mm	10 mm	1.25 mm	5	Pack	12 Piece	L	336868 GP
50 mm	50 mm	10 mm	1.25 mm	50	Piece	-	L	336905
50 mm	50 mm	10 mm	1.25 mm	5	Pack	12 Piece	L	336912 GP
60 mm	60 mm	10 mm	1.25 mm	50	Piece	-	L	336950
60 mm	60 mm	10 mm	1.25 mm	5	Pack	8 Piece	L	336967 GP
75 mm	75 mm	12 mm	1.25 mm	50	Piece	-	L	337001
75 mm	75 mm	12 mm	1.25 mm	5	Pack	8 Piece	L	337018 GP
75 mm	75 mm	12 mm	1.25 mm	10	Card	4 Piece	L	337025 →
100 mm	100 mm	15 mm	1.50 mm	50	Piece	-	L	337056
Material: raw steel, Surface: zinc phosphate plated, white powder-coated								
100 mm	100 mm	15 mm	1.50 mm	25	Piece	-	L	337094

Corner plate, rounded ends

with countersunk screw holes

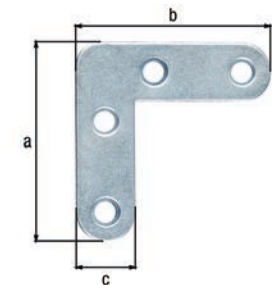

Dimension a	Dimension b	Dimension c	UNIT	PU	Contents per PU	Deliv-ery time	Order no. 4004338...
Material: raw steel, Surface: blue galvanised							
40 mm	40 mm	12 mm	100	Piece	-	L	329754
60 mm	60 mm	16 mm	50	Piece	-	L	339500
80 mm	80 mm	16 mm	50	Piece	-	L	339517
100 mm	100 mm	20 mm	50	Piece	-	L	339524

Flat angle bracket

with countersunk screw holes

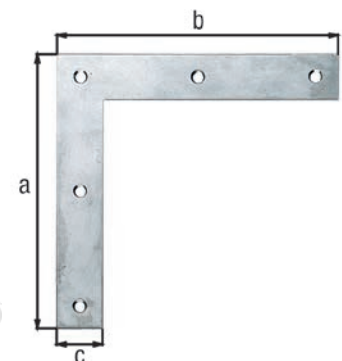

Dimension a	Dimension b	Dimension c	Material thickness	UNIT	PU	Contents per PU	Deliv-ery time	Order no. 4004338...
Material: raw steel, Surface: sendzimir galvanised								
120 mm	120 mm	20 mm	1.50 mm	40	Piece	-	L	332853
120 mm	120 mm	20 mm	1.50 mm	10	Pack	12 Piece	L	332877 GP
160 mm	160 mm	30 mm	3.00 mm	10	Piece	-	L	332907
200 mm	200 mm	30 mm	3.00 mm	10	Piece	-	L	332952
Material: stainless steel								
120 mm	120 mm	20 mm	1.50 mm	10	Piece	-	L	361105 VA

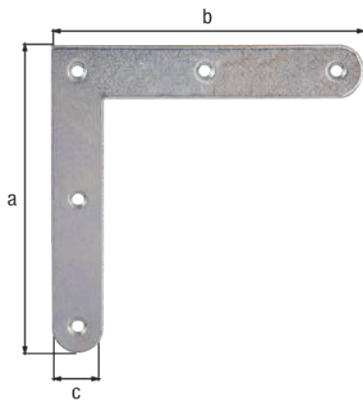

Flat angle bracket, rounded ends

with countersunk screw holes

Material thickness: 2.00 mm

Dimension a	Dimension b	Dimension c	UNIT	PU	Contents per PU	Deliv-ery time	Order no. 4004338...
Material: raw steel, Surface: galvanised, thick-film passivated							
120 mm	120 mm	20 mm	20	Piece	-	L	339739
150 mm	150 mm	20 mm	20	Piece	-	L	339746
Material: raw steel, Surface: blue galvanised							
120 mm	120 mm	20 mm	20	Piece	-	L	339791
150 mm	150 mm	20 mm	20	Piece	-	L	339845

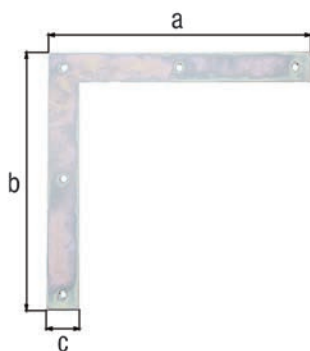

L shaped strap tie for gates

with countersunk screw holes

Material thickness: 3.00 mm

Dimension a	Dimension b	Dimension c	UNIT	PU	Contents per PU	Deliv-ery time	Order no. 4004338...
Material: raw steel, Surface: galvanised, thick-film passivated							
200 mm	200 mm	30 mm	10	Piece	-	L	312558
250 mm	250 mm	30 mm	10	Piece	-	L	313043
300 mm	300 mm	40 mm	10	Piece	-	L	313098
Material: raw steel, Surface: blue galvanised							
200 mm	200 mm	30 mm	10	Piece	-	L	312565
250 mm	250 mm	30 mm	10	Piece	-	L	312916

Wide angle bracket equal sided

with countersunk screw holes

Material thickness: 2.00 mm

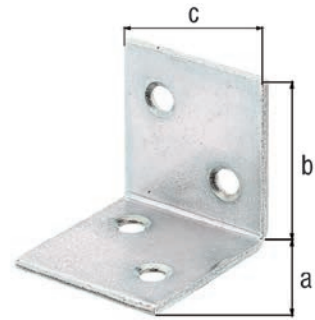

Dimension a	Dimension b	Dimension c	UNIT	PU	Contents per PU	Deliv-ery time	Order no. 4004338...
Material: raw steel, Surface: sendzimir galvanised							
30 mm	30 mm	30 mm	100	Piece	-	L	332600
30 mm	30 mm	30 mm	10	Pack	25 Piece	L	332631 GP
40 mm	40 mm	40 mm	50	Piece	-	L	332655
40 mm	40 mm	40 mm	6	Pack	25 Piece	L	332686 GP
60 mm	60 mm	60 mm	50	Piece	-	L	332709
60 mm	60 mm	60 mm	4	Pack	25 Piece	L	332723 GP
Material: raw steel, Surface: blue galvanised							
30 mm	30 mm	30 mm	100	Piece	-	L	337049
40 mm	40 mm	40 mm	50	Piece	-	L	337063
60 mm	60 mm	60 mm	50	Piece	-	L	337070
Material: raw steel, Surface: blue galvanised, black powder-coated							
30 mm	30 mm	30 mm	50	Piece	-	L	338886
Material: raw steel, Surface: zinc phosphate plated, white powder-coated							
30 mm	30 mm	30 mm	50	Piece	-	L	332624
40 mm	40 mm	40 mm	50	Piece	-	L	332679
Material: stainless steel							
30 mm	30 mm	30 mm	25	Piece	-	L	361075 VA
40 mm	40 mm	40 mm	10	Piece	-	L	361082 VA

Wide angle bracket unequal sided

with countersunk screw holes

Material thickness: 2.00 mm

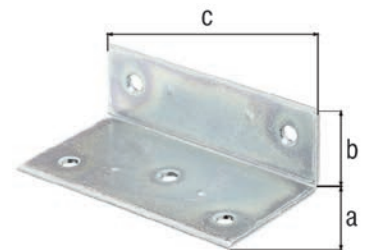

Dimension a	Dimension b	Dimension c	UNIT	PU	Contents per PU	Deliv-ery time	Order no. 4004338...
Material: raw steel, Surface: sendzimir galvanised							
40 mm	25 mm	75 mm	50	Piece	-	L	332501
60 mm	40 mm	115 mm	25	Piece	-	L	332556
Material: raw steel, Surface: blue galvanised							
40 mm	25 mm	75 mm	50	Piece	-	L	337032

Wide angle bracket, embossed, unequal sided

Material thickness: 1.50 mm

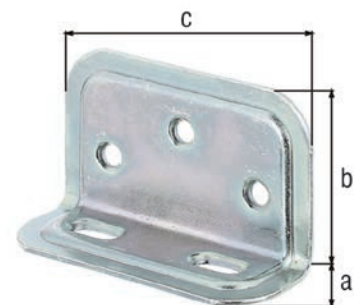

Dimension a	Dimension b	Dimension c	UNIT	PU	Contents per PU	Deliv-ery time	Order no. 4004338...
Material: raw steel, Surface: galvanised, thick-film passivated							
25 mm	40 mm	70 mm	20	Piece	-	L	340209
Material: raw steel, Surface: zinc phosphate plated, white powder-coated							
25 mm	40 mm	70 mm	20	Piece	-	L	340230

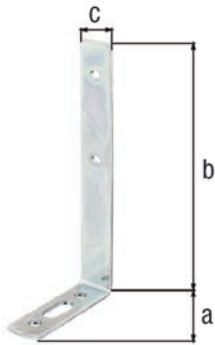

Curtain angle

Material thickness: 2.50 mm

Dimension a	Dimension b	Dimension c	UNIT	PU	Contents per PU	Deliv-ery time	Order no. 4004338...
Material: raw steel, Surface: galvanised, thick-film passivated							
55 mm	120 mm	17 mm	20	Piece	-	L	333959
55 mm	180 mm	17 mm	20	Piece	-	L	334000

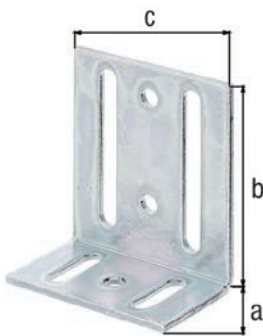

Adjustable angle connector

Material thickness: 3.00 mm

Dimension a	Dimension b	Dimension c	UNIT	PU	Contents per PU	Deliv-ery time	Order no. 4004338...
Material: raw steel, Surface: galvanised, thick-film passivated							
40 mm	77 mm	65 mm	25	Piece	-	L	332754
Material: stainless steel							
35 mm	75 mm	65 mm	10	Piece	-	L	361068

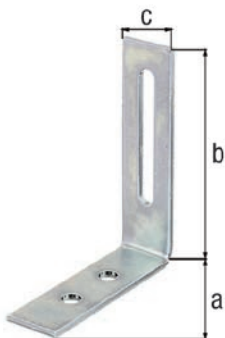

Adjustable angle connector

Material thickness: 2.50 mm

Dimension a	Dimension b	Dimension c	UNIT	PU	Contents per PU	Deliv-ery time	Order no. 4004338...
Material: raw steel, Surface: galvanised, thick-film passivated							
65 mm	80 mm	20 mm	25	Piece	-	L	332808
Material: raw steel, Surface: blue galvanised							
65 mm	80 mm	20 mm	25	Piece	-	L	336936
Material: raw steel, Surface: zinc phosphate plated, white powder-coated							
65 mm	80 mm	20 mm	50	Piece	-	L	332815



Adjustable angle connector, embossed

with countersunk screw holes

Material thickness: 1.25 mm

Dimension a	Dimension b	Dimension c	UNIT	PU	Contents per PU	Deliv-ery time	Order no. 4004338...
Material: raw steel, Surface: galvanised, thick-film passivated							
25 mm	25 mm	30 mm	50	Piece	-	L	340100
Material: raw steel, Surface: zinc phosphate plated, white powder-coated							
25 mm	25 mm	30 mm	50	Piece	-	L	340131

Adjustable angle connector, embossed

with countersunk screw holes

Material thickness: 1.00 mm

Dimension a	Dimension b	Dimension c	UNIT	PU	Contents per PU	Deliv-ery time	Order no. 4004338...
Material: raw steel, Surface: galvanised, thick-film passivated							
28 mm	40 mm	22 mm	50	Piece	-	L	332785

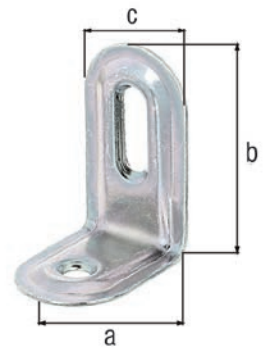

Adjustable angle connector for constructions with concrete

Material thickness: 8.00 mm

Dimension a	Dimension b	Dimension c	UNIT	PU	Contents per PU	Deliv-ery time	Order no. 4004338...
Material: raw steel, Surface: hot-dip galvanised							
77 mm	77 mm	60 mm	20	Piece	-	L	335069
80 mm	150 mm	60 mm	10	Piece	-	L	335656

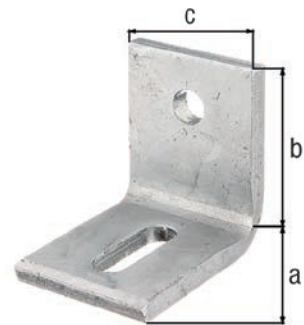

Adjustable angle connector, stamped, 2 angles 45°

Material thickness: 1.50 mm

Dimension a	Dimension b	Dimension c	Dimension d	UNIT	PU	Contents per PU	Deliv-ery time	Order no. 4004338...
Material: raw steel, Surface: sendzimir galvanised								
35 mm	30 mm	50 mm	32 mm	50	Piece	-	L	341343
35 mm	30 mm	50 mm	32 mm	6	Pack	6 Piece	L	333621 GP
50 mm	30 mm	50 mm	32 mm	50	Piece	-	L	341350
50 mm	30 mm	60 mm	32 mm	50	Piece	-	L	341367
50 mm	30 mm	80 mm	32 mm	50	Piece	-	L	341374
50 mm	30 mm	100 mm	32 mm	25	Piece	-	L	341381
50 mm	30 mm	110 mm	32 mm	25	Piece	-	L	341398
50 mm	30 mm	110 mm	32 mm	6	Pack	6 Piece	L	333775 GP
50 mm	30 mm	120 mm	32 mm	25	Piece	-	L	341404
50 mm	30 mm	120 mm	32 mm	6	Pack	6 Piece	L	333768 GP

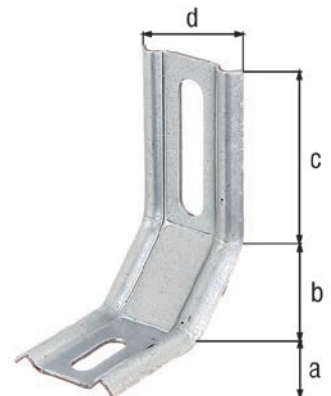

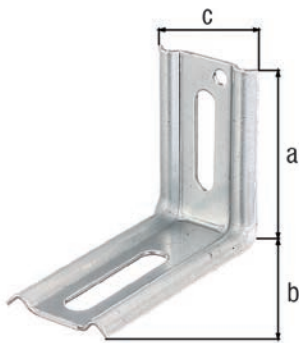

Adjustable angle connector, stamped, 90° angle

Material thickness: 1.50 mm

Dimension a	Dimension b	Dimension c	UNIT	PU	Contents per PU	Deliv-ery time	Order no. 4004338...
Material: raw steel, Surface: sendzimir galvanised							
50 mm	70 mm	30 mm	50	Piece	-	L	339906
70 mm	70 mm	30 mm	50	Piece	-	L	339913
80 mm	70 mm	30 mm	50	Piece	-	L	339920
100 mm	70 mm	30 mm	50	Piece	-	L	339937
120 mm	70 mm	30 mm	25	Piece	-	L	339944
130 mm	70 mm	30 mm	25	Piece	-	L	339951
140 mm	70 mm	30 mm	25	Piece	-	L	339968

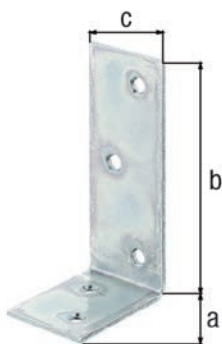

Joist hanger angle bracket unequal sided

with countersunk screw holes

Dimension a	Dimension b	Dimension c	Material thickness	UNIT	PU	Contents per PU	Deliv-ery time	Order no. 4004338...
Material: raw steel, Surface: galvanised, thick-film passivated								
40 mm	80 mm	30 mm	2.00 mm	20	Piece	-	L	332839
50 mm	100 mm	40 mm	4.00 mm	20	Piece	-	L	333300
75 mm	100 mm	30 mm	3.00 mm	50	Piece	-	L	332259
75 mm	100 mm	30 mm	3.00 mm	8	Pack	6 Piece	L	335175
75 mm	150 mm	40 mm	4.00 mm	20	Piece	-	L	333355
80 mm	120 mm	35 mm	4.00 mm	25	Piece	-	L	332303
100 mm	200 mm	40 mm	4.00 mm	20	Piece	-	L	333409
120 mm	180 mm	40 mm	4.00 mm	20	Piece	-	L	334055
160 mm	240 mm	50 mm	5.00 mm	10	Piece	-	L	334154
Material: raw steel, Surface: blue galvanised								
50 mm	100 mm	40 mm	4.00 mm	20	Piece	-	L	337377
75 mm	100 mm	30 mm	3.00 mm	50	Piece	-	L	336646
75 mm	150 mm	40 mm	4.00 mm	20	Piece	-	L	337384
80 mm	120 mm	35 mm	4.00 mm	25	Piece	-	L	336691
100 mm	200 mm	40 mm	4.00 mm	20	Piece	-	L	337391
120 mm	180 mm	40 mm	4.00 mm	20	Piece	-	L	338046
Material: raw steel, Surface: zinc phosphate plated, brown, powder-coated								
75 mm	100 mm	30 mm	3.00 mm	50	Piece	-	L	332266

Joist hanger angle bracket, narrow, equal-sided

with countersunk screw holes

Material thickness: 5.00 mm

Dimension a	Dimension b	Dimension c	UNIT	PU	Contents per PU	Deliv-ery time	Order no. 4004338...
Material: raw steel, Surface: galvanised, thick-film passivated							
80 mm	80 mm	20 mm	20	Piece	-	L	333058
100 mm	100 mm	20 mm	20	Piece	-	L	333102
120 mm	120 mm	20 mm	20	Piece	-	L	333157
140 mm	140 mm	20 mm	20	Piece	-	L	333201
160 mm	160 mm	20 mm	10	Piece	-	L	333256
180 mm	180 mm	20 mm	10	Piece	-	L	339135
Material: raw steel, Surface: blue galvanised							
80 mm	80 mm	20 mm	20	Piece	-	L	337087
100 mm	100 mm	20 mm	20	Piece	-	L	337339
120 mm	120 mm	20 mm	20	Piece	-	L	337346
140 mm	140 mm	20 mm	20	Piece	-	L	337353
160 mm	160 mm	20 mm	10	Piece	-	L	337360
180 mm	180 mm	20 mm	10	Piece	-	L	339531
200 mm	200 mm	26 mm	25	Piece	-	L	327293
250 mm	250 mm	26 mm	25	Piece	-	L	333225
Material: raw steel, Surface: zinc phosphate plated, white powder-coated							
100 mm	100 mm	20 mm	20	Piece	-	L	333126
120 mm	120 mm	20 mm	20	Piece	-	L	333171
160 mm	160 mm	20 mm	10	Piece	-	L	333270

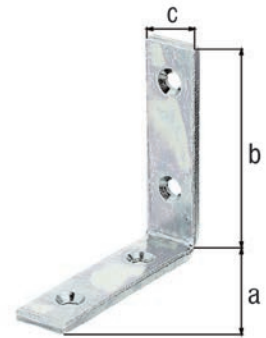

Joist hanger angle bracket, wide, equal-sided

with countersunk screw holes

Dimension a	Dimension b	Dimension c	Material thickness	UNIT	PU	Contents per PU	Deliv-ery time	Order no. 4004338...
Material: raw steel, Surface: galvanised, thick-film passivated								
100 mm	100 mm	40 mm	4.00 mm	20	Piece	-	L	333508
150 mm	150 mm	40 mm	4.00 mm	20	Piece	-	L	333553
200 mm	200 mm	40 mm	5.00 mm	10	Piece	-	L	333607
Material: raw steel, Surface: blue galvanised								
100 mm	100 mm	40 mm	4.00 mm	20	Piece	-	L	337421
150 mm	150 mm	40 mm	4.00 mm	20	Piece	-	L	337445
200 mm	200 mm	40 mm	5.00 mm	10	Piece	-	L	337575

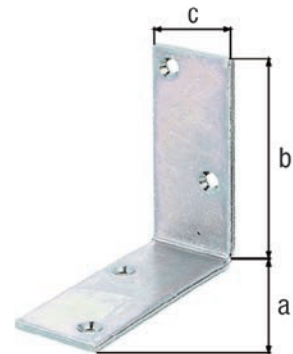



Decorative angle bracket, stamped

with countersunk screw holes

Dimension a	Dimension b	Dimension c	Material thickness	UNIT	PU	Contents per PU	Deliv-ery time	Order no. 4004338...
Material: raw steel, Surface: galvanised, thick-film passivated								
50 mm	50 mm	20 mm	1.00 mm	40	Piece	-	L	337117
75 mm	75 mm	20 mm	1.00 mm	20	Piece	-	L	337124
103 mm	103 mm	21 mm	2.00 mm	20	Piece	-	L	337131
130 mm	130 mm	21 mm	1.50 mm	10	Piece	-	L	337148
Material: raw steel, Surface: aluminium-grey powder-coated								
50 mm	50 mm	20 mm	1.00 mm	20	Piece	-	L	337155
75 mm	75 mm	20 mm	1.00 mm	10	Piece	-	L	337162
103 mm	103 mm	21 mm	2.00 mm	10	Piece	-	L	337179
130 mm	130 mm	21 mm	1.50 mm	10	Piece	-	L	337186
Material: raw steel, Surface: white powder-coated								
30 mm	30 mm	20 mm	1.00 mm	20	Piece	-	L	337193
50 mm	50 mm	20 mm	1.00 mm	20	Piece	-	L	337230
75 mm	75 mm	20 mm	1.00 mm	10	Piece	-	L	337247
103 mm	103 mm	21 mm	2.00 mm	10	Piece	-	L	337285
130 mm	130 mm	21 mm	1.50 mm	10	Piece	-	L	337292

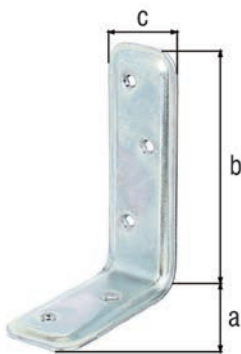

Supporting angle bracket, embossed

with countersunk screw holes

Material thickness: 2.00 mm

Dimension a	Dimension b	Dimension c	UNIT	PU	Contents per PU	Deliv-ery time	Order no. 4004338...
Material: raw steel, Surface: galvanised, thick-film passivated							
80 mm	120 mm	40 mm	20	Piece	-	L	340308
100 mm	160 mm	40 mm	20	Piece	-	L	340407
Material: raw steel, Surface: zinc phosphate plated, white powder-coated							
80 mm	120 mm	40 mm	20	Piece	-	L	340339
100 mm	160 mm	40 mm	20	Piece	-	L	340438

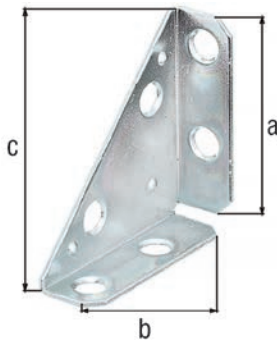

L shaped strap tie

with screw hole countersunk from the inside

Dimension a	Dimension b	Dimension c	Material thickness	UNIT	PU	Contents per PU	Deliv-ery time	Order no. 4004338...
Material: raw steel, Surface: sendzimir galvanised								
50 mm	50 mm	70 mm	1.50 mm	25	Piece	-	L	337254
75 mm	75 mm	105 mm	2.00 mm	25	Piece	-	L	337261

Flat connector

with countersunk screw holes

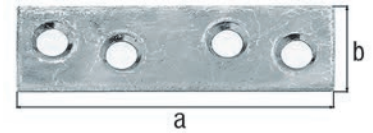

Dimension a	Dimension b	Material thickness	UNIT	PU	Contents per PU	Deliv-ery time	Order no. 4004338...
Material: raw steel, Surface: sendzimir galvanised							
136 mm	20 mm	2.00 mm	100	Piece	-	L	339777
156 mm	20 mm	2.00 mm	100	Piece	-	L	339784
50 mm	14 mm	1.75 mm	100	Piece	-	L	339241
50 mm	14 mm	1.75 mm	5	Pack	12 Piece	L	336417 GP
60 mm	14 mm	1.75 mm	100	Piece	-	L	339258
60 mm	14 mm	1.75 mm	5	Pack	12 Piece	L	336431 GP
80 mm	15 mm	1.75 mm	100	Piece	-	L	339265
80 mm	15 mm	1.75 mm	5	Pack	8 Piece	L	336486 GP
120 mm	16 mm	1.75 mm	100	Piece	-	L	339289
Material: raw steel, Surface: blue galvanised							
100 mm	15 mm	1.75 mm	100	Piece	-	L	339586
Material: stainless steel							
100 mm	15 mm	1.75 mm	50	Piece	-	L	361150 VA

Flat connector rounded ends

with countersunk screw holes

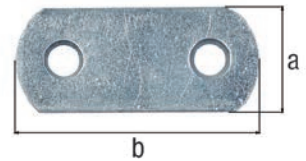

Dimension a	Dimension b	Material thickness	UNIT	PU	Contents per PU	Deliv-ery time	Order no. 4004338...
Material: raw steel, Surface: blue galvanised							
16 mm	37 mm	1.50 mm	100	Piece	-	L	329952
16 mm	57 mm	1.50 mm	100	Piece	-	L	329969
19 mm	77 mm	2.00 mm	100	Piece	-	L	329976

Flat connector, embossed

with countersunk screw holes

Material thickness: 2.00 mm

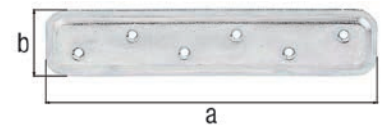

Dimension a	Dimension b	UNIT	PU	Contents per PU	Deliv-ery time	Order no. 4004338...
Material: raw steel, Surface: galvanised, thick-film passivated						
180 mm	40 mm	20	Piece	-	L	340506
Material: raw steel, Surface: white powder-coated						
180 mm	40 mm	20	Piece	-	L	340537

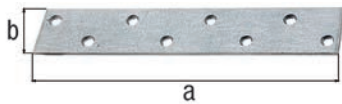

Flat connector

Material thickness: 3.00 mm

Dimension a	Dimension b	UNIT	PU	Contents per PU	Deliv-ery time	Order no.
Material: raw steel, Surface: sendzimir galvanised						
170 mm	30 mm	50	Piece	-	L	333904

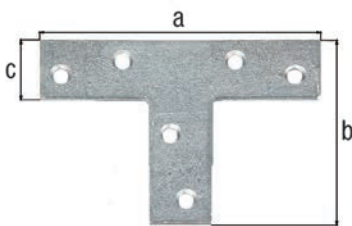

Flat connector T shaped

with countersunk screw holes

Material thickness: 2.00 mm

Dimension a	Dimension b	Dimension c	UNIT	PU	Contents per PU	Deliv-ery time	Order no.
Material: raw steel, Surface: sendzimir galvanised							
70 mm	50 mm	16 mm	50	Piece	-	L	333003
140 mm	110 mm	30 mm	25	Piece	-	L	335052

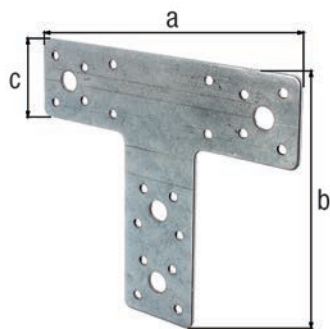

Flat connector T shaped

Dimension a	Dimension b	Dimension c	UNIT	PU	Contents per PU	Deliv-ery time	Order no.
Material: raw steel, Surface: sendzimir galvanised							
80 mm	106 mm	38 mm	20	Piece	-	L	340513
160 mm	142 mm	45 mm	20	Piece	-	L	353322



Assortment kit with angle brackets and mending plates

Set components:

One set consists of four 25 x 25 mm anlg brackets, eight 40 x 40 mm angle brackets, four 60 x 60 mm angle brackets, four 75 x 75 mm angle brackets, four 40 x 40 mm corner plates, four 60 x 60 mm corner plates, four 40 mm mending plates, four 80 mm mending plates with screws, packed in a box with transparent cover

UNIT	PU	Contents per PU	Delivery time	Order no.
Material: raw steel, Surface: blue galvanised				
10	Pack	1 Piece	L	332747

Builders band

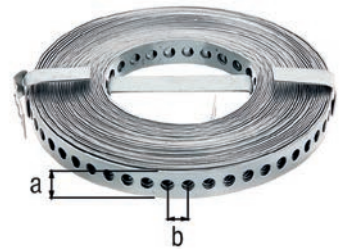

Dimension a	Dimension b	Hole-Ø 1	Length	Material thickness	UNIT	PU	Contents per PU	Deliv-ery time	Order no. 4004338...
Material: raw steel, Surface: sendzimir galvanised									
12 mm	8 mm	5 mm	10 m	0.80 mm	5	Piece	-	L	334130
17 mm	12 mm	7 mm	10 m	0.80 mm	5	Piece	-	L	334208
20 mm	12 mm	7 mm	10 m	1.00 mm	5	Piece	-	L	334239
Material: raw steel, Surface: galvanised, black powder-coated									
12 mm	8 mm	5 mm	1.5 m	0.80 mm	5	Piece	-	L	334123
17 mm	12 mm	7 mm	1.5 m	0.80 mm	5	Piece	-	L	334161
20 mm	12 mm	7 mm	1.5 m	1.00 mm	5	Piece	-	L	334222
Material: raw steel, Surface: galvanised, white powder-coated									
12 mm	8 mm	5 mm	1.5 m	0.80 mm	5	Piece	-	L	334116
17 mm	12 mm	7 mm	1.5 m	0.80 mm	5	Piece	-	L	334253
Material: stainless steel									
17 mm	12 mm	7 mm	10 m	0.80 mm	5	Piece	-	L	361143

VA

Builders band

Length: 3 m

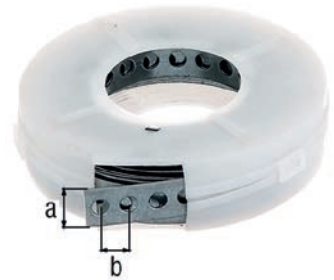

Dimension a	Dimension b	Hole-Ø 1	Material thickness	UNIT	PU	Contents per PU	Deliv-ery time	Order no. 4004338...
Material: raw steel, Surface: sendzimir galvanised, in a roll-out cassette								
12 mm	8 mm	5 mm	0.80 mm	5	Piece	-	L	334147
17 mm	12 mm	7 mm	0.80 mm	5	Piece	-	L	334178
20 mm	12 mm	7 mm	1.00 mm	5	Piece	-	L	334246

HINGES

Made to last.

Chest hinge

with stainless steel pin

Material thickness: 0.50 mm

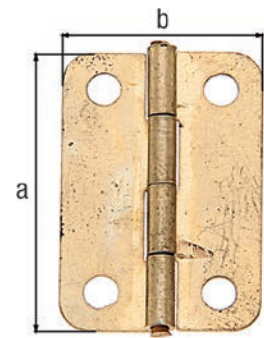

Dimension a	Dimension b	UNIT	PU	Contents per PU	Delivery time	Order no. 4004338...
Material: raw steel, Surface: brass-plated						
24 mm	17 mm	10	Card	4 Piece	L	347062

Hinge, narrow

with countersunk screw holes

Type: rolled

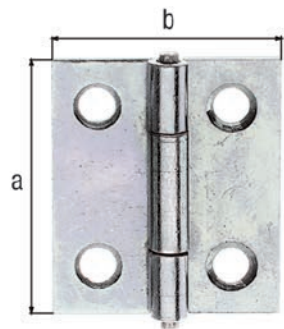

Dimension a	Dimension b	Material thickness	UNIT	PU	Contents per PU	Delivery time	Order no. 4004338...
Material: raw steel, Surface: yellow galvanised, with riveted stainless steel pin							
25.5 mm	22 mm	0.75 mm	50	Piece	-	L	345358
Material: raw steel, Surface: sendzimir galvanised, with riveted stainless steel pin							
31.5 mm	26 mm	0.75 mm	50	Piece	-	L	345365
38.0 mm	26 mm	0.75 mm	50	Piece	-	L	345372
51.0 mm	30 mm	0.75 mm	20	Piece	-	L	345389
64.0 mm	34 mm	1.00 mm	20	Piece	-	L	345396
70.0 mm	35 mm	1.00 mm	20	Piece	-	L	345402
82.0 mm	45 mm	1.20 mm	20	Piece	-	L	345419
100.0 mm	49 mm	1.25 mm	10	Piece	-	L	345426
Material: brass with riveted brass pin							
64.0 mm	34 mm	1.00 mm	20	Piece	-	L	345495
Material: stainless steel, with riveted stainless steel pin							
64.0 mm	34 mm	1.00 mm	10	Piece	-	L	361181 VA
82.0 mm	44 mm	1.30 mm	20	Piece	-	L	361198 VA

Hinge, medium

with loose stainless steel pin

with countersunk screw holes

Type: rolled

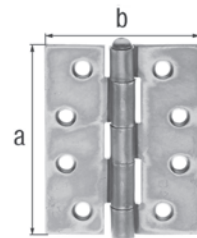

Dimension a	Dimension b	Material thickness	UNIT	PU	Contents per PU	Delivery time	Order no. 4004338...
Material: raw steel, Surface: sendzimir galvanised							
63 mm	45 mm	1.50 mm	25	Piece	-	L	349073

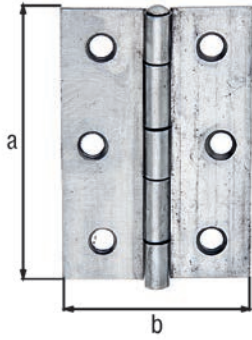

Hinge, medium

with riveted stainless steel pin
with countersunk screw holes

Type: rolled

Dimension a	Dimension b	Material thickness	UNIT	PU	Contents per PU	Deliv-ery time	Order no. 4004338...
Material: raw steel, Surface: sendzimir galvanised							
41 mm	33 mm	1.00 mm	50	Piece	-	L	345877
51 mm	37 mm	1.00 mm	20	Piece	-	L	345884
63 mm	43 mm	1.20 mm	20	Piece	-	L	345891
70 mm	53 mm	1.20 mm	20	Piece	-	L	345907
80 mm	58 mm	1.50 mm	20	Piece	-	L	345914
101 mm	65 mm	1.50 mm	20	Piece	-	L	345921
100 mm	75 mm	2.50 mm	20	Piece	-	L	348991
Material: stainless steel							
VA 63 mm	43 mm	1.25 mm	20	Piece	-	L	361235
VA 80 mm	58 mm	1.50 mm	20	Piece	-	L	361242

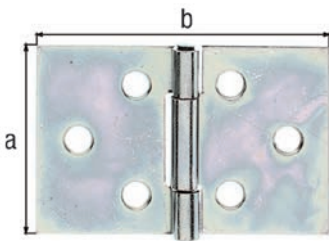

Hinge, wide

with riveted stainless steel pin

division up to 40 mm = three-part, for more than 50 mm = five-part
Type: rolled

Dimension a	Dimension b	Material thickness	UNIT	PU	Contents per PU	Deliv-ery time	Order no. 4004338...
Material: raw steel, Surface: yellow galvanised							
25 mm	38.5 mm	0.75 mm	10	Card	2 Piece	L	346553
Material: raw steel, Surface: sendzimir galvanised							
30 mm	47.0 mm	1.00 mm	50	Piece	-	L	346461
40 mm	58.0 mm	0.90 mm	20	Piece	-	L	346478
50 mm	74.0 mm	1.00 mm	20	Piece	-	L	346485
60 mm	90.0 mm	1.25 mm	20	Piece	-	L	346492
70 mm	104.5 mm	1.25 mm	20	Piece	-	L	346508
81 mm	128.0 mm	1.50 mm	20	Piece	-	L	346515
100 mm	152.0 mm	2.00 mm	10	Piece	-	L	346539
Material: stainless steel							
VA 60 mm	90.0 mm	1.25 mm	10	Piece	-	L	361280
VA 81 mm	128.0 mm	1.50 mm	20	Piece	-	L	361297

Hinge, squared

with countersunk screw holes

division up to 40 mm = three-part, for more than 50 mm = five-part
Type: rolled

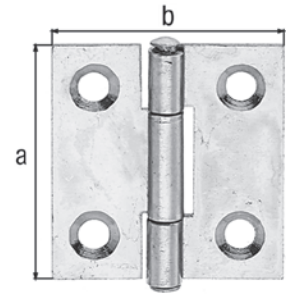

Dimension a	Dimension b	Material thickness	UNIT	PU	Contents per PU	Deliv-ery time	Order no. 4004338...
Material: raw steel, Surface: sendzimir galvanised, with riveted stainless steel pin							
31 mm	31 mm	0.75 mm	50	Piece	-	L	345969
38 mm	38 mm	0.75 mm	50	Piece	-	L	345976
51 mm	51 mm	0.75 mm	20	Piece	-	L	345983
64 mm	64 mm	1.00 mm	20	Piece	-	L	345990
70 mm	70 mm	1.50 mm	20	Piece	-	L	346003
82 mm	82 mm	1.00 mm	20	Piece	-	L	346010
100 mm	100 mm	1.20 mm	10	Piece	-	L	346027
100 mm	100 mm	2.50 mm	20	Piece	-	L	349042
Material: raw steel, Surface: blue galvanised, with riveted stainless steel pin							
80 mm	80 mm	1.25 mm	20	Piece	-	L	346102
100 mm	100 mm	1.25 mm	10	Piece	-	L	346188
Material: brass with riveted brass pin							
64 mm	64 mm	1.00 mm	20	Piece	-	L	346096
Material: stainless steel, with riveted stainless steel pin							
51 mm	51 mm	0.75 mm	20	Piece	-	L	361259 VA
60 mm	60 mm	1.50 mm	20	Piece	-	L	361266 VA
82 mm	82 mm	1.00 mm	20	Piece	-	L	361273 VA

Hinge, squared

with loose stainless steel pin
with countersunk screw holes

Type: rolled

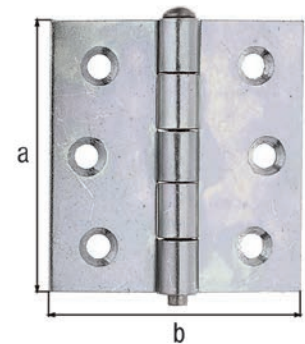

Dimension a	Dimension b	Material thickness	UNIT	PU	Contents per PU	Deliv-ery time	Order no. 4004338...
Material: raw steel, Surface: sendzimir galvanised							
63 mm	63 mm	2.00 mm	25	Piece	-	L	349028
76 mm	76 mm	2.00 mm	25	Piece	-	L	349035
Material: raw steel, Surface: blue galvanised, with riveted stainless steel pin							
76 mm	76 mm	2.00 mm	25	Piece	-	L	339593
Material: raw steel, Surface: sendzimir galvanised							
100 mm	100 mm	2.50 mm	20	Piece	-	L	348984
Material: raw steel, Surface: blue galvanised							
63 mm	63 mm	2.00 mm	25	Piece	-	L	349189
Material: stainless steel							
76 mm	76 mm	2.00 mm	24	Piece	-	L	361211 VA

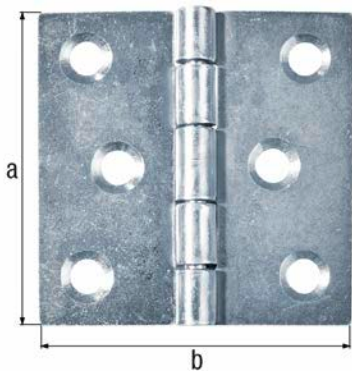

Hinge, squared

with countersunk screw holes

Type: rolled

Item description	Dimension a	Dimension b	Material thickness	UNIT	PU	Contents per PU	Deliv-ery time	Order no. 4004338...
Material: raw steel, Surface: sendzimir galvanised								
narrow	25 mm	20 mm	0.80 mm	100	Piece	-	L	345129
quadratic	30 mm	30 mm	1.00 mm	100	Piece	-	L	345136
quadratic	40 mm	42 mm	1.00 mm	50	Piece	-	L	345143
half-width	50 mm	42 mm	1.00 mm	50	Piece	-	L	345150
half-width	60 mm	45 mm	1.00 mm	50	Piece	-	L	345167
half-width	70 mm	49 mm	1.00 mm	50	Piece	-	L	345174

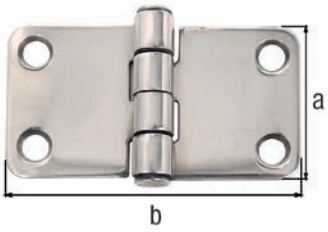

Hinge

with countersunk screw holes

Material thickness: 2.00 mm

Dimension a	Dimension b	UNIT	PU	Contents per PU	Deliv-ery time	Order no. 4004338...
Material: stainless steel, V4A / AISI 316 / DIN 1.4401						
V4A 38 mm	68 mm	5	Piece	1 Piece	L	725075

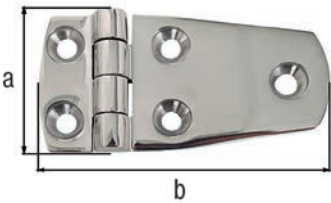

Hinge

with countersunk screw holes

Material thickness: 2.00 mm

Dimension a	Dimension b	UNIT	PU	Contents per PU	Deliv-ery time	Order no. 4004338...
Material: stainless steel, V4A / AISI 316 / DIN 1.4401						
V4A 38 mm	68 mm	5	Piece	1 Piece	L	725068

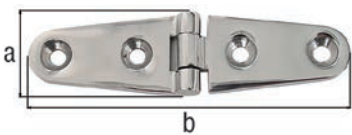

Hinge

with countersunk screw holes

Material thickness: 4.00 mm

Dimension a	Dimension b	UNIT	PU	Contents per PU	Deliv-ery time	Order no. 4004338...
Material: stainless steel, V4A / AISI 316 / DIN 1.4401						
V4A 25 mm	100 mm	5	Piece	1 Piece	L	725051

Lift-off hinge

with countersunk screw holes

Dimension a	Dimension b	Material thickness	UNIT	PU	Contents per PU	Delivery time	Order no. 4004338...
Material: raw steel, Surface: sendzimir galvanised, left							
80 mm	65 mm	1.80 mm	20	Piece	-	L	333751
94 mm	45 mm	2.50 mm	10	Piece	-	L	340902
120 mm	88 mm	2.70 mm	10	Piece	-	L	341244
Material: raw steel, Surface: sendzimir galvanised, right							
80 mm	65 mm	1.80 mm	20	Piece	-	L	333805
94 mm	45 mm	2.50 mm	10	Piece	-	L	340919
120 mm	88 mm	2.70 mm	10	Piece	-	L	341251

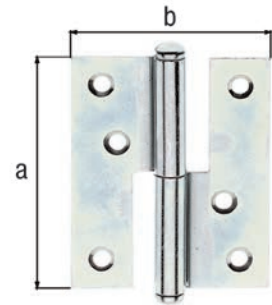

Fig. pin right

Lift-off hinge, adjustable

with countersunk screw holes

adjustable from: 60 - 85 mm

Dimension a	Dimension b	Dimension c	Dimension d	UNIT	PU	Contents per PU	Delivery time	Order no. 4004338...
Material: raw steel, Surface: galvanised, thick-film passivated								
83 mm	15 mm	40 mm	40 mm	20	Piece	-	L	341060

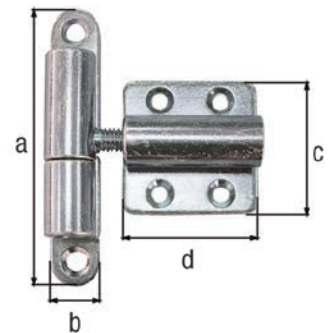

Lift-off hinge, type Paris

with countersunk screw holes

Dimension a	Dimension b	Material thickness	UNIT	PU	Contents per PU	Delivery time	Order no. 4004338...
Material: raw steel, Surface: blue galvanised, left							
80 mm	40 mm	2.50 mm	12	Piece	-	L	341268
95 mm	45 mm	2.50 mm	12	Piece	-	L	341275
110 mm	55 mm	3.00 mm	12	Piece	-	L	341282
140 mm	55 mm	3.00 mm	12	Piece	-	L	341299
Material: raw steel, Surface: blue galvanised, right							
80 mm	40 mm	2.50 mm	12	Piece	-	L	341305
95 mm	45 mm	2.50 mm	12	Piece	-	L	341312
110 mm	55 mm	3.00 mm	12	Piece	-	L	341329
140 mm	55 mm	3.00 mm	12	Piece	-	L	341336

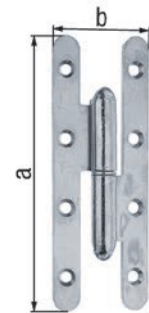
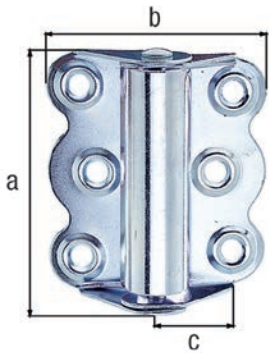

Fig. pin left



Hinge, self-closing

with countersunk screw holes

Material thickness: 1.00 mm

Dimension a	Dimension b	Dimension c	UNIT	PU	Contents per PU	Deliv-ery time	Order no. 4004338...
Material: raw steel, Surface: blue galvanised							
70 mm	65 mm	22 mm	6	bulk	1 Piece	L	341046
Material: raw steel, Surface: blue galvanised, black powder-coated							
70 mm	65 mm	22 mm	6	bulk	1 Piece	L	341053

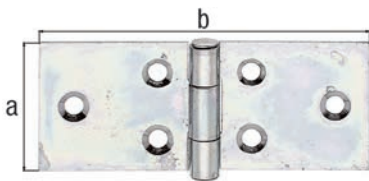

Table hinge

with riveted stainless steel pin

with countersunk screw holes

Type: rolled

Dimension a	Dimension b	Material thickness	UNIT	PU	Contents per PU	Deliv-ery time	Order no. 4004338...
Material: raw steel, Surface: sendzimir galvanised							
25 mm	61.0 mm	0.90 mm	20	Piece	-	L	346867
26 mm	81.0 mm	1.30 mm	20	Piece	-	L	346874
32 mm	101.0 mm	1.50 mm	20	Piece	-	L	346881
32 mm	120.5 mm	1.50 mm	20	Piece	-	L	346898
34 mm	141.0 mm	1.50 mm	20	Piece	-	L	346904
40 mm	162.0 mm	1.50 mm	20	Piece	-	L	346911
40 mm	181.0 mm	1.50 mm	20	Piece	-	L	346928
44 mm	203.0 mm	2.00 mm	10	Piece	-	L	346935
Material: stainless steel							
VA	26 mm	81.0 mm	20	Piece	-	L	361334
VA	32 mm	101.0 mm	10	Piece	-	L	361303
VA	35 mm	121.0 mm	20	Piece	-	L	361310
VA	32 mm	141.0 mm	20	Piece	-	L	361327



Ladder hinge, curved

with countersunk screw holes

Material thickness: 4.00 mm

Dimension a	Dimension b	Dimension c	UNIT	PU	Contents per PU	Deliv-ery time	Order no. 4004338...
Material: raw steel, Surface: galvanised							
200 mm	21 mm	88 mm	10	Piece	-	L	341503

BOX FITTINGS

Made to last.

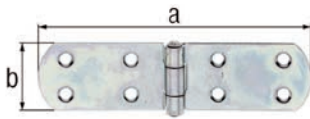

Box hinge

with riveted pin
with countersunk screw holes

Dimension a	Dimension b	Material thickness	UNIT	PU	Contents per PU	Deliv-ery time	Order no. 4004338...
Material: raw steel, Surface: galvanised, thick-film passivated							
135 mm	35 mm	2.00 mm	20	Piece	-	L	315542
156 mm	35 mm	2.00 mm	20	Piece	-	L	315580
175 mm	35 mm	2.00 mm	20	Piece	-	L	315627
195 mm	35 mm	2.00 mm	20	Piece	-	L	315665
250 mm	40 mm	2.50 mm	10	Piece	-	L	315702
300 mm	40 mm	2.50 mm	10	Piece	-	L	315740
400 mm	40 mm	3.00 mm	10	Piece	-	L	315788
Material: raw steel, Surface: blue galvanised							
135 mm	35 mm	2.00 mm	20	Piece	-	L	315467
156 mm	35 mm	2.00 mm	20	Piece	-	L	315474
195 mm	35 mm	2.00 mm	20	Piece	-	L	315504
250 mm	40 mm	2.50 mm	10	Piece	-	L	315511
300 mm	40 mm	2.50 mm	10	Piece	-	L	315818
300 mm	40 mm	2.50 mm	10	Piece	-	L	315528
400 mm	40 mm	3.00 mm	10	Piece	-	L	315535
Material: stainless steel							
VA 200 mm	35 mm	2.00 mm	10	Piece	-	L	327118

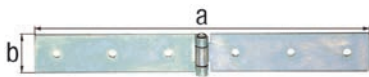

Box hinge

with riveted pin

Type: light
Material thickness: 2.50 mm

Dimension a	Dimension b	UNIT	PU	Contents per PU	Deliv-ery time	Order no. 4004338...
Material: raw steel, Surface: galvanised, thick-film passivated						
400 mm	35 mm	10	Piece	-	L	315900

Box hinge

with riveted pin
with countersunk screw holes

Type: rolled

Accessory note: Suitable fasteners can be found in the range "Screws and accessories".

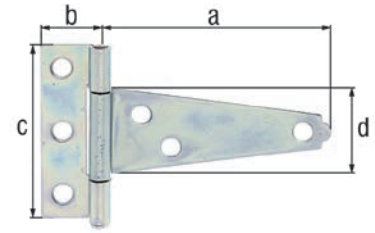

Dimension a	Dimension b	Dimension c	Dimension d	Material thickness	UNIT	PU	Contents per PU	Deliv-ery time	Order no. 4004338...
Material: raw steel, Surface: blue galvanised									
75 mm	20 mm	60 mm	29 mm	1.50 mm	25	Piece	-	L	347246
100 mm	20 mm	60 mm	29 mm	1.50 mm	25	Piece	-	L	347284
125 mm	22.5 mm	70 mm	33.5 mm	1.50 mm	25	Piece	-	L	347291
Material: raw steel, Surface: galvanised, thick-film passivated									
100 mm	20 mm	60 mm	29 mm	1.50 mm	25	Piece	-	L	347314
125 mm	22.5 mm	70 mm	33.5 mm	1.50 mm	25	Piece	-	L	347321
150 mm	22.5 mm	70 mm	33 mm	1.50 mm	25	Piece	-	L	347338
200 mm	32 mm	90 mm	43.5 mm	2.50 mm	10	Piece	-	L	347345
Material: raw steel, Surface: black cataphoretic coating									
75 mm	20 mm	60 mm	29 mm	1.50 mm	25	Piece	-	L	347970
100 mm	20 mm	60 mm	29 mm	1.50 mm	25	Piece	-	L	347987
125 mm	22.5 mm	70 mm	33.5 mm	1.50 mm	25	Piece	-	L	347994

Box hinge

with loose pin
with countersunk screw holes

Material thickness: 1.80 mm

Accessory note: Suitable fasteners can be found in the range "Screws and accessories".

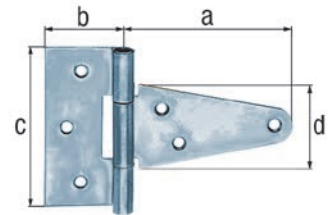

Dimension a	Dimension b	Dimension c	Dimension d	UNIT	PU	Contents per PU	Deliv-ery time	Order no. 4004338...
Material: raw steel, Surface: blue galvanised								
79 mm	40 mm	90 mm	50 mm	10	Piece	-	L	307684
102 mm	40 mm	90 mm	54 mm	10	Piece	-	L	307691
148 mm	40 mm	90 mm	46 mm	10	Piece	-	L	307516
198 mm	40 mm	90 mm	46 mm	10	Piece	-	L	307523
Material: raw steel, Surface: black cataphoretic coating								
79 mm	40 mm	90 mm	50 mm	10	Piece	-	L	306922
102 mm	40 mm	90 mm	54 mm	10	Piece	-	L	306939
148 mm	40 mm	90 mm	46 mm	10	Piece	-	L	306946
198 mm	40 mm	90 mm	46 mm	10	Piece	-	L	306953

Box hinge

with riveted pin

Type: rolled



Dimension a	Dimension b	Material thickness	UNIT	PU	Contents per PU	Deliv-ery time	Order no. 4004338...
Material: raw steel, Surface: galvanised, thick-film passivated							
148 mm	28 mm	1.50 mm	25	Piece	-	L	347109

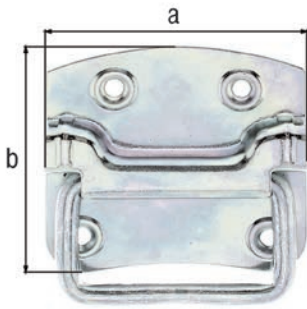

Box handle

with countersunk screw holes
with reinforced screw holes

Dimension a	Dimension b	Depth	Material thickness	UNIT	PU	Contents per PU	Deliv-ery time	Order no. 4004338...
Material: raw steel, Surface: galvanised, thick-film passivated								
80 mm	74 mm	11 mm	1.00 mm	10	Piece	-	L	347505
104 mm	80 mm	12 mm	1.20 mm	10	Piece	-	L	347529
120 mm	85 mm	12 mm	1.50 mm	10	Piece	-	L	347536
Material: raw steel, Surface: blue galvanised								
80 mm	74 mm	11 mm	1.00 mm	10	Piece	-	L	347499
120 mm	85 mm	12 mm	1.50 mm	10	Piece	-	L	347482
Material: stainless steel								
VA 92 mm	80 mm	12 mm	1.20 mm	10	Piece	-	L	361402

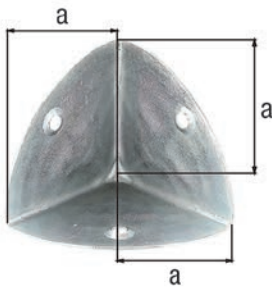

Box corner

with countersunk screw holes

Dimension a	Material thickness	UNIT	PU	Contents per PU	Deliv-ery time	Order no. 4004338...
Material: raw steel, Surface: galvanised, thick-film passivated						
30 mm	0.80 mm	50	Piece	-	L	347604
35 mm	0.80 mm	25	Piece	-	L	347611
Material: stainless steel						
VA 36 mm	1.00 mm	20	Piece	-	L	361396

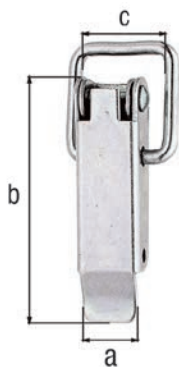

Hasp with latch without lock eye and without closing hook

with countersunk screw holes

Dimension a	Dimension b	Dimension c	Clip Ø	For hook width	UNIT	PU	Contents per PU	Deliv-ery time	Order no. 4004338...
Material: raw steel, Surface: galvanised, thick-film passivated									
13 mm	49 mm	15 mm	3 mm	13 mm	50	Piece	-	L	347703
18 mm	61 mm	22 mm	4 mm	18 mm	50	Piece	-	L	347710
24 mm	94 mm	30 mm	4 mm	25 mm	25	Piece	-	L	347727
Material: stainless steel									
VA 20 mm	94 mm	30 mm	4 mm	25 mm	10	Piece	-	L	361358

Hasp with latch without lock eye, with cranked closing hook

with countersunk screw holes

Dimension a	Dimension b	Dimension c	Clip Ø	For hook width	UNIT	PU	Contents per PU	Deliv-ery time	Order no. 4004338...
Material: raw steel, Surface: galvanised, thick-film passivated									
13 mm	49 mm	15 mm	3 mm	13 mm	10	Card	1 Piece	L	347956
18 mm	61 mm	22 mm	4 mm	18 mm	10	Card	1 Piece	L	347963



Hasp with latch with lock eye, without closing hook

with countersunk screw holes

with sash lock
suitable for padlocks of max. Ø 10 mm
For hook width: 25 mm
Clip Ø: 4 mm

Dimension a	Dimension b	Dimension c	UNIT	PU	Contents per PU	Deliv-ery time	Order no. 4004338...
Material: raw steel, Surface: galvanised, thick-film passivated							
24 mm	93 mm	30 mm	25	Piece	-	L	347772

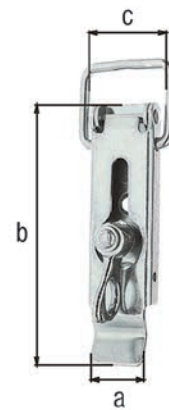

Hasp with latch with lock eye, without closing hook

suitable for padlocks of max. Ø 7 mm
For hook width: 25 mm

Dimension a	Dimension b	Dimension c	Clip Ø	UNIT	PU	Contents per PU	Deliv-ery time	Order no. 4004338...
Material: raw steel, Surface: galvanised, thick-film passivated								
24 mm	93 mm	30 mm	4 mm	25	Piece	-	L	347826
24 mm	93 mm	30 mm	4 mm	25	Piece	-	L	347826

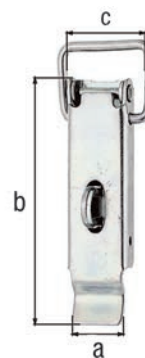

Closing hook, straight

Dimension a	Dimension b	For clip Ø	Material thickness	UNIT	PU	Contents per PU	Deliv-ery time	Order no. 4004338...
Material: raw steel, Surface: galvanised, thick-film passivated								
30 mm	12 mm	4 mm	1.50 mm	50	Piece	-	L	347857
23 mm	18 mm	6 mm	2.00 mm	50	Piece	-	L	347864
34 mm	25 mm	6 mm	2.00 mm	25	Piece	-	L	347871
Material: stainless steel								
34 mm	25 mm	6 mm	2.00 mm	10	Piece	-	L	361372

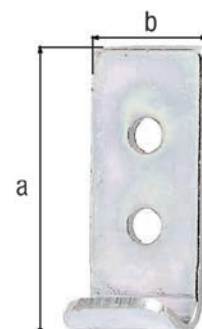

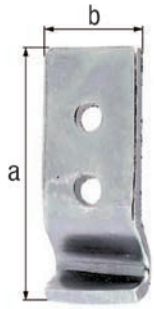

Closing hook, cranked

Material thickness: 2.00 mm

Dimension a	Dimension b	For clip Ø	UNIT	PU	Contents per PU	Deliv-ery time	Order no. 4004338...
Material: raw steel, Surface: galvanised, thick-film passivated							
32 mm	13 mm	4 mm	50	Piece	-	L	347901
50 mm	18 mm	4 mm	50	Piece	-	L	347918
83 mm	25 mm	6 mm	25	Piece	-	L	347925

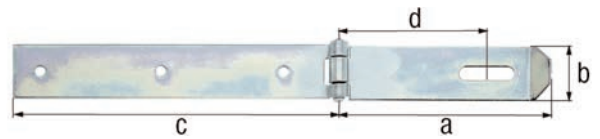

Hasp, straight end

Material thickness: 2.50 mm

Dimension a	Dimension b	Dimension c	Dimension d	UNIT	PU	Contents per PU	Delivery time	Order no.
Material: raw steel, Surface: galvanised, thick-film passivated								
140 mm	35 mm	210 mm	99.0 mm	10	Piece	-	L	315986
167 mm	35 mm	210 mm	126.5 mm	10	Piece	-	L	316020

Hasp

with countersunk screw holes

with eye plate
for padlocks with max. Ø 8 mm
Material thickness: 2.00 mm

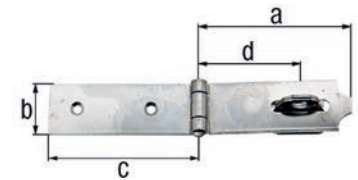

Dimension a	Dimension b	Dimension c	Dimension d	UNIT	PU	Contents per PU	Delivery time	Order no.
Material: stainless steel								
99 mm	35 mm	99 mm	66.5 mm	5	Piece	-	L	361419 VA

Hasp with staple, made of rolled wire

with countersunk screw holes

with eye plate
for padlocks with max. size, according to table

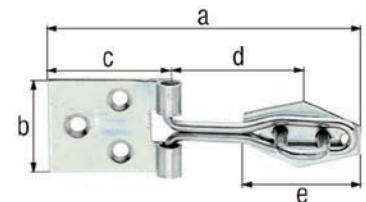

Dimension a	Dimension b	Dimension c	Dimension d	Dimension e	Padlock Ø	UNIT	PU	Contents per PU	Delivery time	Order no.
Material: raw steel, Surface: galvanised, thick-film passivated										
80.0 mm	26.0 mm	30.0 mm	35 mm	31 mm	7 mm	10	Piece	-	L	348205
93.5 mm	31.5 mm	33.5 mm	42 mm	42 mm	10 mm	10	Piece	-	L	348212
93.5 mm	31.5 mm	33.5 mm	42 mm	42 mm	10 mm	10	Piece	-	L	348212
120.0 mm	31.5 mm	35.0 mm	67 mm	43 mm	10 mm	10	Piece	-	L	348229
140.0 mm	36.0 mm	45.0 mm	73 mm	58 mm	12 mm	10	Piece	-	L	348267

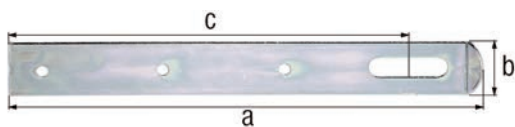

Hasp without hook

Material thickness: 3.00 mm

Dimension a	Dimension b	Dimension c	UNIT	PU	Contents per PU	Deliv-ery time	Order no.
Material: raw steel, Surface: galvanised, thick-film passivated							
250 mm	30 mm	112 mm	10	Piece	-	L	316266

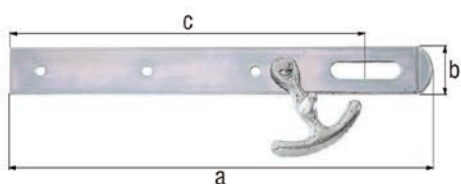

Hasp with hook

applicable DIN left and right
Material thickness: 3.00 mm

Dimension a	Dimension b	Dimension c	UNIT	PU	Contents per PU	Deliv-ery time	Order no.
Material: raw steel, Surface: galvanised, thick-film passivated							
250 mm	30 mm	112 mm	10	Piece	-	L	316389

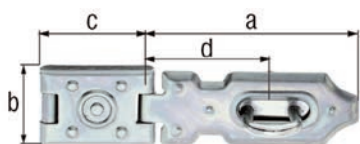

Security closing hasp, stamped

with blind screw holes
with eye plate
suitable for padlocks of max. Ø 10 mm

Dimension a	Dimension b	Dimension c	Dimension d	UNIT	PU	Contents per PU	Deliv-ery time	Order no.
Material: raw steel, Surface: galvanised, thick-film passivated								
70 mm	26 mm	35 mm	42 mm	10	Piece	-	L	348304

Security closing hasp

with blind screw holes
with countersunk screw holes
with eye plate

Dimen- sion a	Dimen- sion b	Dimen- sion c	Dimen- sion d	Padlock Ø	Material thickness	UNIT	PU	Contents per PU	Deliv- ery time	Order no. 4004338...
Material: raw steel, Surface: galvanised, thick-film passivated										
85 mm	37 mm	38 mm	62.5 mm	12 mm	2.00 mm	10	Piece	-	L	348359
93 mm	37 mm	38 mm	70.5 mm	12 mm	2.00 mm	10	Piece	-	L	348366
153 mm	50 mm	68 mm	121.5 mm	15 mm	3.00 mm	5	Piece	-	L	348373
Material: raw steel, Surface: blue galvanised										
85 mm	37 mm	38 mm	62.5 mm	12 mm	2.00 mm	10	Piece	-	L	348403
93 mm	37 mm	38 mm	70.5 mm	12 mm	2.00 mm	10	Piece	-	L	348410
153 mm	50 mm	68 mm	121.5 mm	15 mm	3.00 mm	5	Piece	-	L	348472

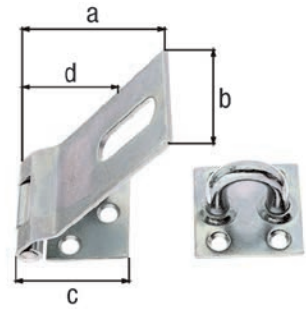

Security closing hasp

with blind screw holes
with countersunk screw holes
with eye plate
for padlocks with max. Ø 11 mm
Material thickness: 1.50 mm

Dimension a	Dimension b	Dimension c	Dimension d	Dimension e	UNIT	PU	Contents per PU	Deliv- ery time	Order no. 4004338...
Material: stainless steel									
83 mm	37 mm	30 mm	56 mm	35 mm	10	Piece	-	L	361426 VA

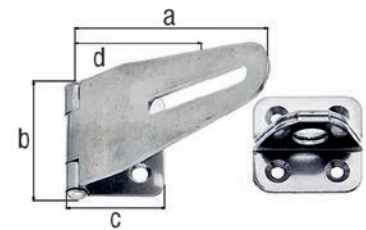

Security closing hasp, lockable

with countersunk screw holes
with blind screw holes
die-cast lock with brass interior parts
Material thickness: 1.75 mm

Accessory note: Two nickel-plated keys included.
The locks in a unit are not keyed alike.

Dimension a	Dimension b	Dimension c	Dimension d	UNIT	PU	Contents per PU	Deliv- ery time	Order no. 4004338...
Material: raw steel, Surface: chrome-plated								
100 mm	41.5 mm	40 mm	70 mm	10	Piece	-	L	348458

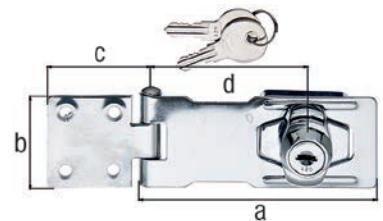

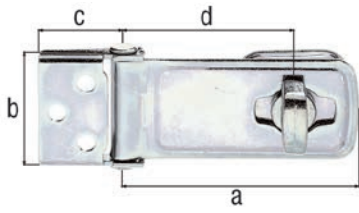

Security closing hasp

with blind screw holes

spring-mounted, rotatable eyelet can therefore be bolted without lock for padlocks with max. Ø 9 mm
Material thickness: 2.00 mm

Dimension a	Dimension b	Dimension c	Dimension d	UNIT	PU	Contents per PU	Deliv-ery time	Order no. 4004338...
Material: raw steel, Surface: galvanised, thick-film passivated								
85 mm	40 mm	30 mm	62 mm	10	Piece	-	L	348397

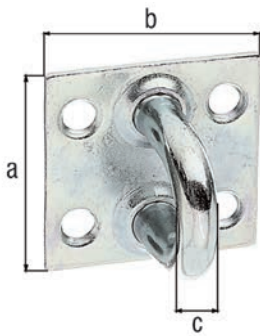

Eye plate

no. 348519 for hasp no. 348373
no. 348502 for hasps nos. 315986, 316020, 316266, 316389, 348359, 348366

Dimension a	Dimension b	Dimension c-Ø	Clip width	Clip height	Material thickness	UNIT	PU	Contents per PU	Deliv-ery time	Order no. 4004338...
Material: raw steel, Surface: galvanised, thick-film passivated										
37 mm	37 mm	7 mm	27.5 mm	27 mm	2.00 mm	25	Piece	-	L	348502
50 mm	50 mm	8 mm	32.0 mm	29 mm	3.00 mm	10	Piece	-	L	348519
Material: raw steel, Surface: blue galvanised										
37 mm	37 mm	7 mm	27.5 mm	27 mm	2.00 mm	25	Piece	-	L	348496

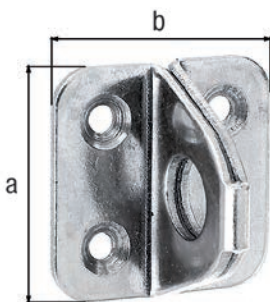

Eye plate

with countersunk screw holes

fits security hasps 361419, 361426
Material thickness: 2.00 mm

Dimension a	Dimension b	UNIT	PU	Contents per PU	Deliv-ery time	Order no. 4004338...
Material: stainless steel						
35 mm	35 mm	25	Piece	-	L	361433

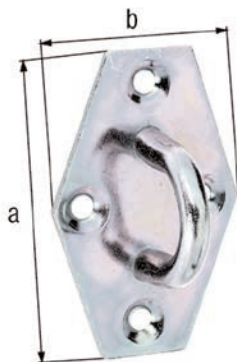

Eye plate

with countersunk screw holes

fits security hasps 315986, 316020, 316143, 316266
Clip width: 31 mm
Clip height: 23 mm
Clip Ø: 6 mm

Dimension a	Dimension b	UNIT	PU	Contents per PU	Deliv-ery time	Order no. 4004338...
Material: raw steel, Surface: galvanised, thick-film passivated						
64 mm	41 mm	25	Piece	-	L	316471

HINGES, SHUTTER HINGES AND HOOKS

Made to last.

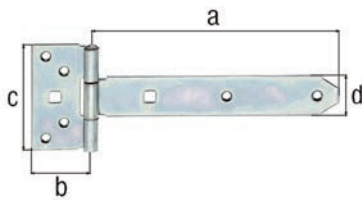

Tee hinge

with riveted pin

Type: light

Accessory note: Suitable fasteners can be found in the range "Screws and accessories".

	Dimension a	Dimension b	Dimension c	Dimension d	Material thickness	UNIT	PU	Contents per PU	Deliv-ery time	Order no. 4004338...
Material: raw steel, Surface: galvanised, thick-film passivated										
	192.0 mm	45 mm	90 mm	34 mm	2.00 mm	10	Piece	-	L	310615
	242.5 mm	45 mm	90 mm	34 mm	2.00 mm	10	Piece	-	L	310660
	292.5 mm	45 mm	90 mm	34 mm	2.30 mm	10	Piece	-	L	310714
	393.5 mm	44 mm	92 mm	34 mm	2.50 mm	10	Piece	-	L	310813
Material: raw steel, Surface: blue galvanised										
	192.0 mm	45 mm	90 mm	34 mm	2.00 mm	10	Piece	-	L	310608
Material: stainless steel										
VA	191.5 mm	44 mm	92 mm	34 mm	3.00 mm	6	Piece	-	L	327125
VA	242.0 mm	44 mm	92 mm	34 mm	3.00 mm	6	Piece	-	L	327132
VA	292.0 mm	44 mm	92 mm	34 mm	3.00 mm	6	Piece	-	L	326142

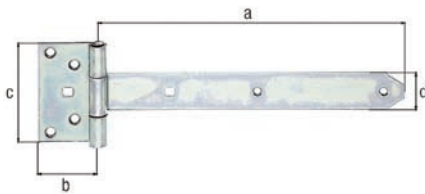

Tee hinge

with riveted pin

Type: heavy

Material thickness: 3.50 mm

Accessory note: Suitable fasteners can be found in the range "Screws and accessories".

	Dimension a	Dimension b	Dimension c	Dimension d	UNIT	PU	Contents per PU	Deliv-ery time	Order no. 4004338...
Material: raw steel, Surface: galvanised, thick-film passivated									
	291 mm	59 mm	103 mm	40 mm	10	Piece	-	L	310912
	391 mm	59 mm	103 mm	40 mm	10	Piece	-	L	310967
	491 mm	59 mm	103 mm	40 mm	10	Piece	-	L	311018
	591 mm	59 mm	103 mm	40 mm	10	Piece	-	L	311063

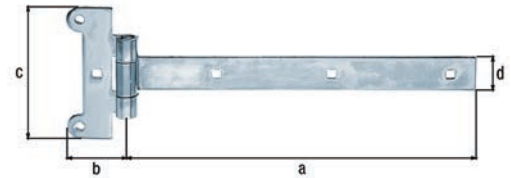

Tee hinge

with press-fitted pin

Material thickness: 4.00 mm

Dimension a	Dimension b	Dimension c	Dimension d	UNIT	PU	Contents per PU	Deliv-ery time	Order no. 4004338...
Material: raw steel, Surface: blue galvanised								
291 mm	45 mm	115 mm	30 mm	10	Piece	-	L	308834
391 mm	45 mm	115 mm	30 mm	10	Piece	-	L	308841
491 mm	45 mm	115 mm	30 mm	10	Piece	-	L	308858
591 mm	45 mm	115 mm	30 mm	10	Piece	-	L	308865
Material: raw steel, Surface: black cataphoretic coating								
291 mm	45 mm	115 mm	30 mm	10	Piece	-	L	307004
391 mm	45 mm	115 mm	30 mm	10	Piece	-	L	307011
491 mm	45 mm	115 mm	30 mm	10	Piece	-	L	307028
591 mm	45 mm	115 mm	30 mm	10	Piece	-	L	308872

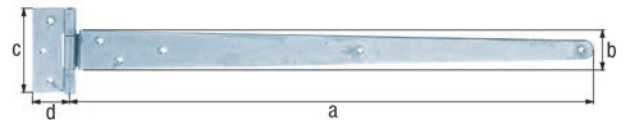

Tee hinge

with countersunk screw holes

with loose pin

Accessory note: Suitable fasteners can be found in the range "Screws and accessories".

Dimension a	Dimension b	Dimension c	Dimension d	Material thickness	UNIT	PU	Contents per PU	Deliv-ery time	Order no. 4004338...
Material: raw steel, Surface: blue galvanised									
248 mm	40 mm	90 mm	46 mm	1.80 mm	10	Piece	-	L	307530
294 mm	40 mm	90 mm	46 mm	2.50 mm	10	Piece	-	L	309800
348 mm	40 mm	90 mm	46 mm	2.50 mm	10	Piece	-	L	309817
397 mm	40 mm	90 mm	46 mm	2.50 mm	10	Piece	-	L	309824
495 mm	40 mm	90 mm	46 mm	2.50 mm	10	Piece	-	L	309831
596 mm	40 mm	90 mm	48 mm	2.50 mm	10	Piece	-	L	309848
Material: raw steel, Surface: black cataphoretic coating									
248 mm	40 mm	90 mm	46 mm	1.80 mm	10	Piece	-	L	306960
294 mm	40 mm	90 mm	46 mm	2.50 mm	10	Piece	-	L	309855
348 mm	40 mm	90 mm	46 mm	2.50 mm	10	Piece	-	L	309862
495 mm	40 mm	90 mm	46 mm	2.50 mm	10	Piece	-	L	309886
596 mm	40 mm	90 mm	48 mm	2.50 mm	10	Piece	-	L	309893
397 mm	40 mm	90 mm	46 mm	2.50 mm	10	Piece	-	L	309879

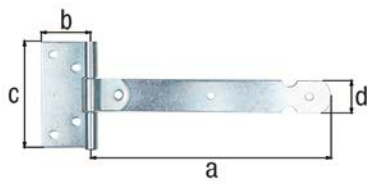

Tee hinge

Dimension a	Dimension b	Dimension c	Dimension d	UNIT	PU	Contents per PU	Deliv-ery time	Order no. 4004338...
Material: raw steel, Surface: blue galvanised								
145 mm	31 mm	65 mm	20 mm	6	Piece	-	L	220112

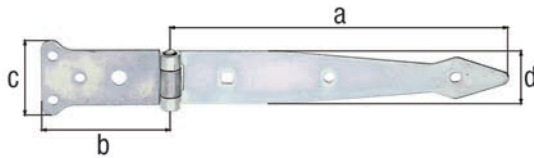

Strap hinge

with riveted pin

Type: light

Material thickness: 2.50 mm

Accessory note: Suitable fasteners can be found in the range "Screws and accessories".

Dimension a	Dimension b	Dimension c	Dimension d	UNIT	PU	Contents per PU	Deliv-ery time	Order no. 4004338...
Material: raw steel, Surface: galvanised, thick-film passivated								
202 mm	77 mm	48 mm	35 mm	10	Piece	-	L	315092
252 mm	77 mm	48 mm	35 mm	10	Piece	-	L	315146
302 mm	77 mm	48 mm	35 mm	10	Piece	-	L	315191
Material: raw steel, Surface: blue galvanised								
202 mm	77 mm	48 mm	35 mm	10	Piece	-	L	315085
302 mm	77 mm	48 mm	35 mm	10	Piece	-	L	315184

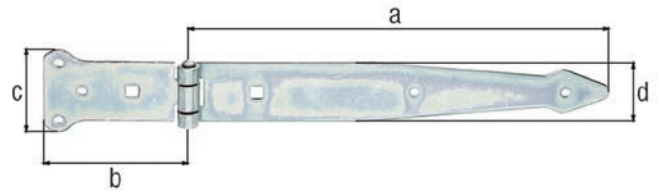

Strap hinge

with riveted pin

Type: heavy

Accessory note: Suitable fasteners can be found in the range "Screws and accessories".

Dimension a	Dimension b	Dimension c	Dimension d	Material thickness	UNIT	PU	Contents per PU	Delivery time	Order no. 4004338...
Material: raw steel, Surface: galvanised, thick-film passivated									
300 mm	101 mm	63 mm	45 mm	3.20 mm	10	Piece	-	L	315344
400 mm	101 mm	63 mm	45 mm	3.60 mm	10	Piece	-	L	315399
500 mm	101 mm	63 mm	45 mm	3.75 mm	10	Piece	-	L	315443
600 mm	101 mm	63 mm	45 mm	3.75 mm	10	Piece	-	L	315498
Material: raw steel, Surface: blue galvanised									
400 mm	101 mm	63 mm	45 mm	3.60 mm	10	Piece	-	L	315382

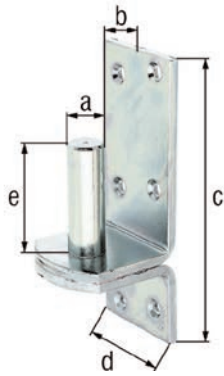

Hook on plate, DI

with countersunk screw holes

Accessory note: Suitable fasteners can be found in the range "Screws and accessories".

Dimension a-Ø	Dimension b	Dimension c	Dimension d	Dimension e	Material thickness	UNIT	PU	Contents per PU	Deliv-ery time	Order no. 4004338...	
Material: raw steel, Surface: galvanised, thick-film passivated											
10 mm	10 mm	90 mm	30 mm	30 mm	2.50 mm	10	Piece	-	L	311155	
13 mm	11 mm	100 mm	35 mm	40 mm	4.00 mm	10	Piece	-	L	311230	
16 mm	13 mm	115 mm	40 mm	45 mm	4.50 mm	10	Piece	-	L	311261	
20 mm	20 mm	167 mm	60 mm	60 mm	6.00 mm	1	Piece	-	L	311315	
Material: raw steel, Surface: blue galvanised											
16 mm	13 mm	115 mm	40 mm	45 mm	4.50 mm	10	Piece	-	L	311124	
Material: raw steel, Surface: hot-dip galvanised											
13 mm	11 mm	100 mm	35 mm	40 mm	4.00 mm	10	Piece	-	L	311209	
16 mm	13 mm	115 mm	40 mm	45 mm	4.50 mm	10	Piece	-	L	311254	
20 mm	20 mm	167 mm	60 mm	60 mm	6.00 mm	1	Piece	-	L	311308	
Material: raw steel, Surface: galvanised, black powder-coated											
16 mm	13 mm	115 mm	40 mm	45 mm	4.50 mm	6	Piece	-	L	309770	
Material: stainless steel											
VA	13 mm	10 mm	100 mm	35 mm	40 mm	4.00 mm	4	Piece	-	L	318215
VA	16 mm	13 mm	115 mm	40 mm	45 mm	5.00 mm	4	Piece	-	L	318222

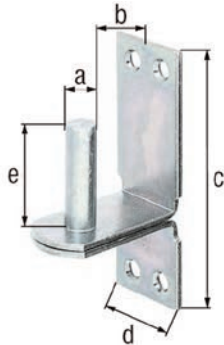

Hook on plate, DII

with countersunk screw holes

Accessory note: Suitable fasteners can be found in the range "Screws and accessories".

Dimension a-Ø	Dimension b	Dimension c	Dimension d	Dimension e	Material thickness	UNIT	PU	Contents per PU	Deliv-ery time	Order no. 4004338...
Material: raw steel, Surface: galvanised, thick-film passivated										
10 mm	25 mm	90 mm	30 mm	30 mm	2.50 mm	10	Piece	-	L	311353
13 mm	25 mm	100 mm	35 mm	40 mm	3.50 mm	10	Piece	-	L	311438
16 mm	28 mm	113 mm	40 mm	45 mm	4.00 mm	10	Piece	-	L	311469
20 mm	35 mm	189 mm	60 mm	60 mm	6.00 mm	1	Piece	-	L	311513
Material: raw steel, Surface: blue galvanised										
16 mm	28 mm	113 mm	40 mm	45 mm	4.50 mm	10	Piece	-	L	311117
Material: raw steel, Surface: hot-dip galvanised										
13 mm	25 mm	100 mm	35 mm	40 mm	4.00 mm	10	Piece	-	L	311407
16 mm	28 mm	113 mm	40 mm	45 mm	4.50 mm	10	Piece	-	L	311452
20 mm	35 mm	189 mm	60 mm	60 mm	6.00 mm	1	Piece	-	L	311506

Hook on plate, DI

Southern German look
with countersunk screw holes

Accessory note: Suitable fasteners can be found in the range "Screws and accessories".

Dimension a-Ø	Dimension b	Dimension c	Dimension d	Dimension e	Material thickness	UNIT	PU	Contents per PU	Deliv-ery time	Order no. 4004338...
Material: raw steel, Surface: galvanised, thick-film passivated										
13 mm	10 mm	110 mm	36 mm	45 mm	4.00 mm	10	Piece	-	L	318772
16 mm	13 mm	133 mm	40 mm	45 mm	5.00 mm	10	Piece	-	L	318796

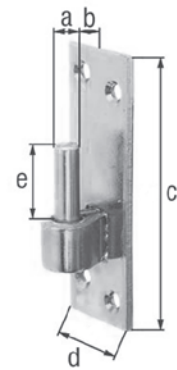

Hook on plate, DII

Southern German look
with countersunk screw holes

Accessory note: Suitable fasteners can be found in the range "Screws and accessories".

Dimension a-Ø	Dimension b	Dimension c	Dimension d	Dimension e	Material thickness	UNIT	PU	Contents per PU	Deliv-ery time	Order no. 4004338...
Material: raw steel, Surface: galvanised, thick-film passivated										
13 mm	25 mm	110 mm	36 mm	45 mm	4.00 mm	10	Piece	-	L	318789
16 mm	28 mm	133 mm	40 mm	45 mm	5.00 mm	10	Piece	-	L	318802

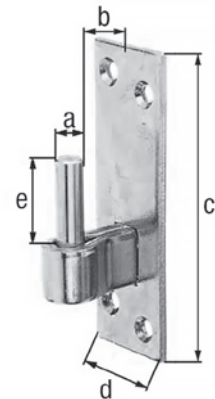

Hook on plate, DI

decorative plate
with countersunk screw holes

Material thickness: 3.50 mm

Dimension a-Ø	Dimension b	Dimension c	Dimension d	Dimension e	UNIT	PU	Contents per PU	Deliv-ery time	Order no. 4004338...
Material: raw steel, Surface: wet paint application, black									
14 mm	15 mm	105 mm	35 mm	45 mm	6	Piece	-	L	323608

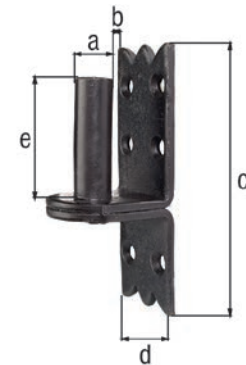

Hook on plate, DI

wrought iron

Type: hammered
Material thickness: 5.00 mm

Accessory note: Suitable fasteners can be found in the range "Screws and accessories".

Dimension a-Ø	Dimension b	Dimension c	Dimension d	Dimension e	UNIT	PU	Contents per PU	Deliv-ery time	Order no. 4004338...
Material: raw steel, Surface: galvanised, black powder-coated									
16 mm	10 mm	150 mm	45 mm	45 mm	2	Piece	-	L	320058

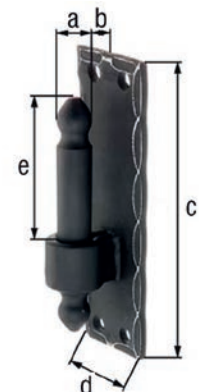

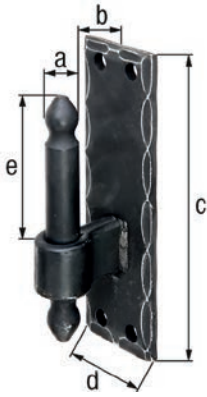

Hook on plate, DII

wrought iron

Type: hammered

Material thickness: 5.00 mm

Accessory note: Suitable fasteners can be found in the range "Screws and accessories".

Dimension a-Ø	Dimension b	Dimension c	Dimension d	Dimension e	UNIT	PU	Contents per PU	Deliv-ery time	Order no. 4004338...
Material: raw steel, Surface: galvanised, black powder-coated									
16 mm	25 mm	150 mm	45 mm	45 mm	2	Piece	-	L	320102

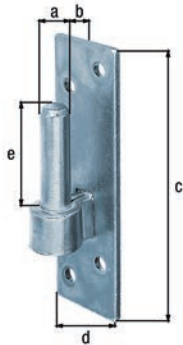

Hook on plate, DI

Accessory note: Suitable fasteners can be found in the range "Screws and accessories".

Dimension a-Ø	Dimension b	Dimension c	Dimension d	Dimension e	Material thickness	UNIT	PU	Contents per PU	Deliv-ery time	Order no. 4004338...
Material: raw steel, Surface: blue galvanised										
14 mm	12 mm	130 mm	40 mm	45 mm	4.00 mm	10	Piece	-	L	306809
16 mm	13 mm	180 mm	40 mm	45 mm	5.00 mm	10	Piece	-	L	306816
Material: raw steel, Surface: black cataphoretic coating										
12 mm	11 mm	130 mm	40 mm	35 mm	4.00 mm	10	Piece	-	L	306670
14 mm	12 mm	130 mm	40 mm	45 mm	4.00 mm	10	Piece	-	L	306687
16 mm	13 mm	180 mm	40 mm	45 mm	5.00 mm	10	Piece	-	L	306694

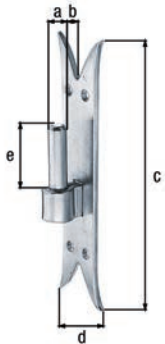

Hook on plate, DI

carp tail end

Material thickness: 5.00 mm

Dimension a-Ø	Dimension b	Dimension c	Dimension d	Dimension e	Material thickness	UNIT	PU	Contents per PU	Deliv-ery time	Order no. 4004338...
Material: raw steel, Surface: blue galvanised										
14 mm	11 mm	205 mm	54 mm	45 mm	5.00 mm	10	Piece	-	L	306830
16 mm	13 mm	205 mm	54 mm	45 mm	5.00 mm	10	Piece	-	L	306847
Material: raw steel, Surface: black cataphoretic coating										
14 mm	11 mm	205 mm	54 mm	45 mm	5.00 mm	10	Piece	-	L	306717
16 mm	13 mm	205 mm	54 mm	45 mm	5.00 mm	10	Piece	-	L	306724

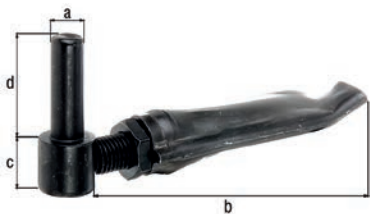

Hook for sealing, type F

can be adjusted by: 27 mm

Thread: M16

Dimension a-Ø	Dimension b	Dimension c	Dimension d	UNIT	PU	Contents per PU	Deliv-ery time	Order no. 4004338...
Material: raw steel, Surface: black cataphoretic coating								
14 mm	110 mm	30 mm	50 mm	1	Piece	-	L	307509

Hook for sealing, type F

Dimension a-Ø	Dimension b	Dimension c	Dimension d	Material thickness	UNIT	PU	Contents per PU	Delivery time	Order no. 4004338...
Material: raw steel, Surface: blue galvanised									
14 mm	92 mm	30 mm	45 mm	5.00 mm	10	Piece	-	L	306779
16 mm	105 mm	40 mm	45 mm	5.00 mm	10	Piece	-	L	306786
Material: raw steel, Surface: black cataphoretic coating									
14 mm	92 mm	30 mm	45 mm	5.00 mm	10	Piece	-	L	306656
16 mm	105 mm	40 mm	45 mm	5.00 mm	10	Piece	-	L	306663

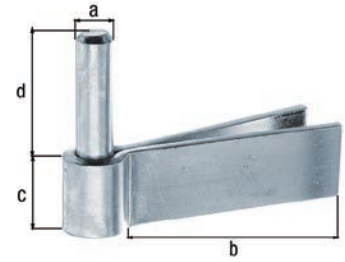

Hook for screwing through, without support

with countersunk screw holes

Accessory note: Square washer and nut included.

Dimension a-Ø	Dimension b	Dimension c	Square washer thickness	UNIT	PU	Contents per PU	Delivery time	Order no. 4004338...
Material: raw steel, Surface: galvanised, thick-film passivated								
16 mm	180 mm	45 mm	6 mm	10	Piece	-	L	318994

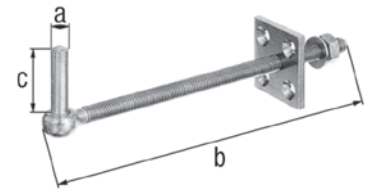

Hook for screwing through, type J

Thread: M12

Dimension a-Ø	Dimension b	Dimension c	UNIT	PU	Contents per PU	Delivery time	Order no. 4004338...
Material: raw steel, Surface: black cataphoretic coating							
16 mm	315 mm	55 mm	5	Piece	-	L	306861



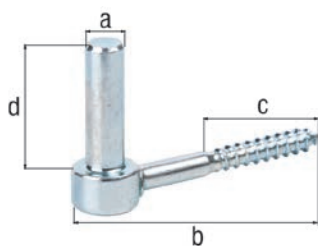

Hook for screwing in, type J

with wood thread

Dimension a-Ø	Dimension b	Dimension c	Dimension d	Wooden thread Ø	UNIT	PU	Contents per PU	Deliv-ery time	Order no. 4004338...
Material: raw steel, Surface: blue galvanised									
14 mm	105 mm	52 mm	45 mm	10 mm	10	Piece	-	L	306748
16 mm	110 mm	52 mm	45 mm	10 mm	10	Piece	-	L	305994
Material: raw steel, Surface: galvanised, thick-film passivated									
10 mm	120 mm	57 mm	35 mm	12 mm	10	Piece	-	L	312084
13 mm	115 mm	57 mm	45 mm	12 mm	10	Piece	-	L	312138
13 mm	165 mm	70 mm	45 mm	12 mm	10	Piece	-	L	312237
16 mm	110 mm	52 mm	45 mm	10 mm	10	Piece	-	L	306755
16 mm	165 mm	70 mm	45 mm	12 mm	10	Piece	-	L	312183
Material: raw steel, Surface: black cataphoretic coating									
12 mm	105 mm	52 mm	35 mm	10 mm	10	Piece	-	L	306618
14 mm	105 mm	52 mm	45 mm	10 mm	10	Piece	-	L	306625
16 mm	110 mm	52 mm	45 mm	10 mm	10	Piece	-	L	306632
Material: stainless steel									
13 mm	155 mm	65 mm	40 mm	12 mm	4	Piece	-	L	326128

VA



Hook for screwing in

Wooden thread Ø: 10 mm

Dimension a-Ø	Dimension b	Dimension c	Dimension d	UNIT	PU	Contents per PU	Deliv-ery time	Order no. 4004338...
Material: wood screw: raw steel, remaining parts: hard PVC, Surface: wood screw: blue galvanised, remaining parts: black								
14 mm	75 mm	50 mm	40 mm	10	Piece	-	L	308070

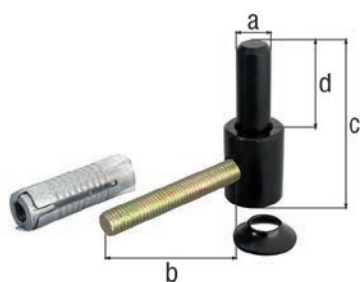

Hook for screwing in

Type: adjustable
Thread: M10

Accessory note: Expansion bolt included.

Dimension a-Ø	Dimension b	Dimension c	Dimension d	UNIT	PU	Contents per PU	Deliv-ery time	Order no. 4004338...
Material: raw steel, Surface: blue galvanised								
14 mm	65 mm	33 mm	35 mm	10	Piece	-	L	307356
16 mm	65 mm	33 mm	45 mm	10	Piece	-	L	307370
Material: raw steel, Surface: black cataphoretic coating								
14 mm	65 mm	33 mm	35 mm	10	Piece	-	L	307363
16 mm	65 mm	33 mm	45 mm	10	Piece	-	L	307387

Hook for screwing in

Thread: M10

Dimension a-Ø	Dimension b	Dimension c	Dimension d	UNIT	PU	Contents per PU	Deliv-ery time	Order no. 4004338...
Material: raw steel, Surface: blue galvanised								
14 mm	125 mm	82 mm	40 mm	10	Piece	-	L	307394
16 mm	125 mm	82 mm	43 mm	10	Piece	-	L	307417
Material: raw steel, Surface: black cataphoretic coating								
14 mm	125 mm	82 mm	40 mm	10	Piece	-	L	307400
16 mm	125 mm	82 mm	43 mm	10	Piece	-	L	307424

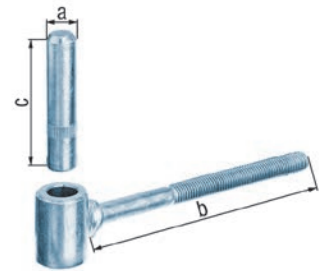

Hook for screwing on

with countersunk screw holes

with nuts and two suspension rings
can be adjusted by: 20 mm

- The hook allows the gate to be adjusted after it has been mounted.

Accessory note: Suitable fasteners can be found in the range "Screws and accessories".

Dimen-sion a-Ø	Dimen-sion b	Dimen-sion c	Dimen-sion d	Dimen-sion e	Thread	Material thickness	UNIT	PU	Contents per PU	Deliv-ery time	Order no. 4004338...
Material: raw steel, Surface: galvanised, thick-film passivated											
13 mm	10.5 mm	105 mm	45 mm	40 mm	M12	8.00 mm	6	Piece	-	L	318239
16 mm	9 mm	105 mm	45 mm	45 mm	M16	8.00 mm	6	Piece	-	L	318246
Material: raw steel, Surface: blue galvanised											
16 mm	9 mm	105 mm	45 mm	45 mm	M16	8.00 mm	6	Piece	-	L	318130
Material: raw steel, Surface: hot-dip galvanised											
13 mm	10.5 mm	105 mm	45 mm	40 mm	M12	4.50 mm	6	Piece	-	L	318758
16 mm	9 mm	105 mm	45 mm	45 mm	M16	4.50 mm	6	Piece	-	L	318765
Material: stainless steel											
13 mm	10.5 mm	105 mm	45 mm	40 mm	M12	4.50 mm	4	Piece	-	L	361471 VA
16 mm	9 mm	105 mm	45 mm	45 mm	M16	4.50 mm	4	Piece	-	L	361488 VA

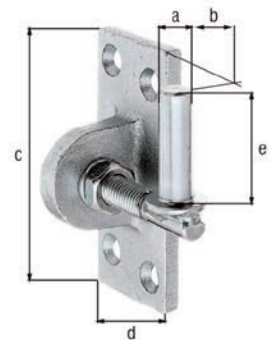

Hook for screwing on, wrought iron

Type: hammered
can be adjusted by: 20 mm
Material thickness: 6.00 mm

Accessory note: Suitable fasteners can be found in the range "Screws and accessories".

Dimension a-Ø	Dimension b	Dimension c	Dimension d	Dimension e	UNIT	PU	Contents per PU	Deliv-ery time	Order no. 4004338...
Material: raw steel, Surface: black powder-coated									
16 mm	13.5 mm	150 mm	45 mm	45 mm	1	Piece	-	L	323066

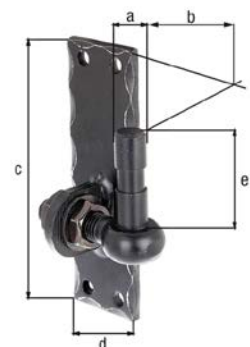

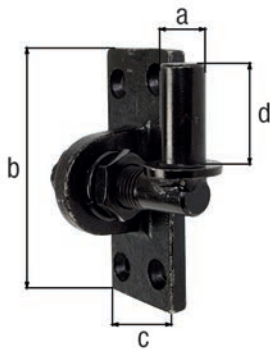

Hook for screwing on, adjustable

with nuts and two suspension rings
can be adjusted by: 20 mm

- The hook allows the gate to be adjusted after it has been mounted.

Accessory note: Suitable fasteners can be found in the range "Screws and accessories".

Dimension a-Ø	Dimension b	Dimension c	Dimension d	UNIT	PU	Contents per PU	Deliv-ery time	Order no.
Material: raw steel, Surface: galvanised black								
16 mm	105 mm	45 mm	35 mm	6	Piece	-	L	340766

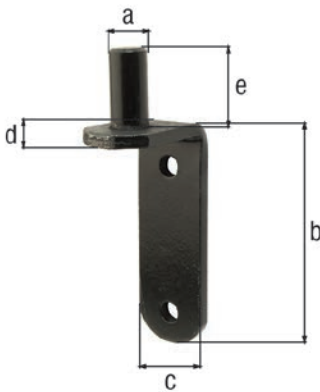

Hook for screwing on

Material thickness: 5.00 mm

Dimension a-Ø	Dimension b	Dimension c	Dimension d	Dimension e	UNIT	PU	Contents per PU	Deliv-ery time	Order no.
Material: raw steel, Surface: wet paint application, black									
14 mm	93 mm	30 mm	46 mm	30 mm	6	Piece	-	L	323547

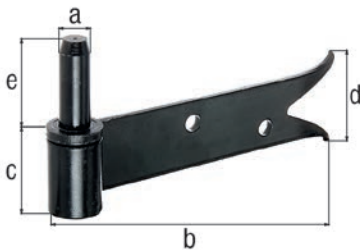

Hook for screwing on, decorative final

applicable DIN left and right
removable pin
Material thickness: 5.00 mm

Dimension a-Ø	Dimension b	Dimension c	Dimension d	Dimension e	UNIT	PU	Contents per PU	Deliv-ery time	Order no.
Material: raw steel, Surface: black cataphoretic coating									
14 mm	171 mm	35 mm	57 mm	40 mm	10	Piece	-	L	307080

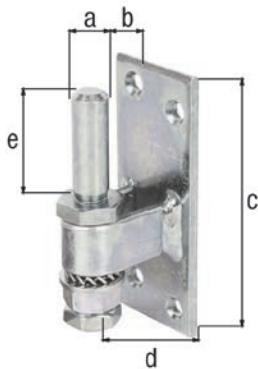

Hook for screwing on

with countersunk screw holes

Type: adjustable
Material thickness: 4.50 mm

Accessory note: Suitable fasteners can be found in the range "Screws and accessories".

Dimension a-Ø	Dimension b	Dimension c	Dimension d	Dimension e	UNIT	PU	Contents per PU	Deliv-ery time	Order no.
Material: raw steel, Surface: galvanised, thick-film passivated									
13 mm	5 - 23 mm	100 mm	40 mm	40 mm	10	Piece	-	L	311131
16 mm	5 - 25 mm	100 mm	40 mm	45 mm	10	Piece	-	L	311148

Hook with ornamental plate

applicable DIN left and right
removable pin

Dimension a-Ø	Dimension b	Dimension c	Dimension d	Dimension e	Material thickness	UNIT	PU	Contents per PU	Deliv-ery time	Order no. 4004338...
Material: raw steel, Surface: black cataphoretic coating										
14 mm	94 mm	94 mm	35 mm	40 mm	4.00 mm	10	Piece	-	L	306588

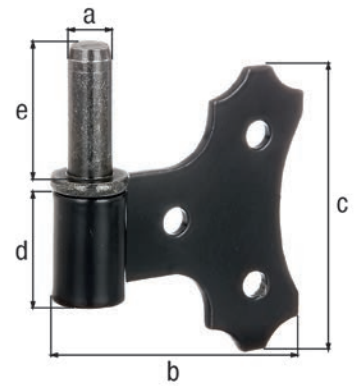

Corner hook to screw on, decorative final

applicable DIN left and right
removable pin
Material thickness: 5.00 mm

Dimension a-Ø	Dimension b	Dimension c	Dimension d	Dimension e	UNIT	PU	Contents per PU	Deliv-ery time	Order no. 4004338...	
Material: raw steel, Surface: black cataphoretic coating										
14 mm	140 mm	120 mm	60 mm	40 mm	4	Piece	-	L	306564	

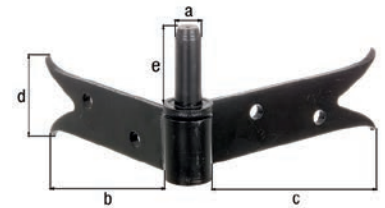

Corner hook for clamping, band adjustable

applicable DIN left and right
removable pin
adjustable from: 90 x 95 to 150 x 155 mm
Material thickness: 5.00 mm

Dimension a-Ø	Dimension b	Dimension c	Dimension d	Dimension e	UNIT	PU	Contents per PU	Deliv-ery time	Order no. 4004338...	
Material: raw steel, Surface: black cataphoretic coating										
14 mm	190 mm	190 mm	35 mm	40 mm	1	Piece	-	L	306571	

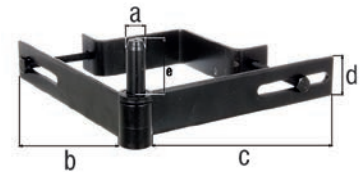

Adapter for hook with pin

suitable for all hooks with pin Ø12 mm

Assembly note: Used to increase the Pin Ø from 12 to 14 mm.

Dimension a-Ø	UNIT	PU	Contents per PU	Deliv-ery time	Order no. 4004338...
Material: PVC, colour: black					
14 mm	50	Piece	-	L	307851



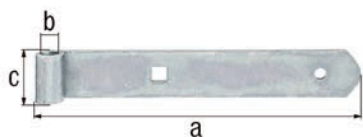

Band hook, straight, rounded

Material thickness: 3.00 mm

Accessory note: Suitable fasteners can be found in the range "Screws and accessories".

Dimension a	Dimension b-Ø	Dimension c	UNIT	PU	Contents per PU	Deliv-ery time	Order no. 4004338...
Material: raw steel, Surface: galvanised, thick-film passivated							
200 mm	10 mm	30 mm	10	Piece	-	L	313630
300 mm	10 mm	30 mm	10	Piece	-	L	313647
400 mm	10 mm	30 mm	10	Piece	-	L	313692
500 mm	10 mm	30 mm	10	Piece	-	L	313746



Band hook, straight, rounded

Accessory note: Suitable fasteners can be found in the range "Screws and accessories".

Dimension a	Dimension b-Ø	Dimension c	Material thickness	UNIT	PU	Contents per PU	Deliv-ery time	Order no. 4004338...
Material: raw steel, Surface: galvanised, thick-film passivated								
300 mm	13 mm	40 mm	5.00 mm	10	Piece	-	L	313807
400 mm	13 mm	40 mm	5.00 mm	10	Piece	-	L	313869
500 mm	13 mm	40 mm	5.00 mm	10	Piece	-	L	313913
600 mm	13 mm	40 mm	5.00 mm	10	Piece	-	L	313968
700 mm	13 mm	40 mm	5.00 mm	10	Piece	-	L	314002
800 mm	13 mm	40 mm	5.00 mm	6	Piece	-	L	314057
Material: raw steel, Surface: hot-dip galvanised								
300 mm	13 mm	40 mm	5.00 mm	10	Piece	-	L	313791
400 mm	13 mm	40 mm	5.00 mm	10	Piece	-	L	313845
500 mm	13 mm	40 mm	5.00 mm	10	Piece	-	L	313890
600 mm	13 mm	40 mm	5.00 mm	10	Piece	-	L	313944
Material: stainless steel								
VA	400 mm	13 mm	40 mm	4	Piece	-	L	313838
VA	600 mm	13 mm	40 mm	4	Piece	-	L	318192



Band hook, straight, rounded

Accessory note: Suitable fasteners can be found in the range “Screws and accessories”.

Dimension a	Dimension b-Ø	Dimension c	Material thickness	UNIT	PU	Contents per PU	Deliv-ery time	Order no. 4004338...
Material: raw steel, Surface: galvanised, thick-film passivated								
400 mm	16 mm	45 mm	5.00 mm	10	Piece	-	L	314101
500 mm	16 mm	45 mm	5.00 mm	10	Piece	-	L	314156
600 mm	16 mm	45 mm	5.00 mm	10	Piece	-	L	314200
700 mm	16 mm	45 mm	5.00 mm	10	Piece	-	L	314255
800 mm	16 mm	45 mm	5.00 mm	6	Piece	-	L	314309
1000 mm	16 mm	45 mm	5.00 mm	6	Piece	-	L	314354
1155 mm	16 mm	45 mm	5.00 mm	4	Piece	-	L	314378
Material: raw steel, Surface: hot-dip galvanised								
400 mm	16 mm	45 mm	5.00 mm	10	Piece	-	L	314095
500 mm	16 mm	45 mm	5.00 mm	10	Piece	-	L	314149
600 mm	16 mm	45 mm	5.00 mm	10	Piece	-	L	314194
700 mm	16 mm	45 mm	5.00 mm	10	Piece	-	L	314248
800 mm	16 mm	45 mm	5.00 mm	6	Piece	-	L	314293
1000 mm	16 mm	45 mm	5.00 mm	10	Piece	-	L	314347
Material: stainless steel								
800 mm	16 mm	45 mm	5.00 mm	4	Piece	-	L	318178 VA

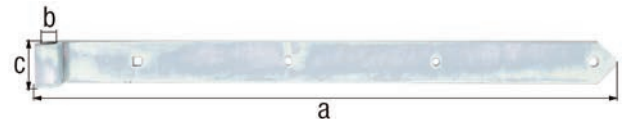

Band hook, straight, rounded

Material thickness: 8.00 mm

Accessory note: Suitable fasteners can be found in the range “Screws and accessories”.

Dimension a	Dimension b-Ø	Dimension c	UNIT	PU	Contents per PU	Deliv-ery time	Order no. 4004338...
Material: raw steel, Surface: galvanised, thick-film passivated							
782 mm	20 mm	60 mm	1	Piece	-	L	312343
982 mm	20 mm	60 mm	1	Piece	-	L	312398
1182 mm	20 mm	60 mm	1	Piece	-	L	312442
1382 mm	20 mm	60 mm	1	Piece	-	L	312497
Material: raw steel, Surface: hot-dip galvanised							
782 mm	20 mm	60 mm	1	Piece	-	L	312336
982 mm	20 mm	60 mm	1	Piece	-	L	312381
1182 mm	20 mm	60 mm	1	Piece	-	L	312435
1382 mm	20 mm	60 mm	1	Piece	-	L	312480

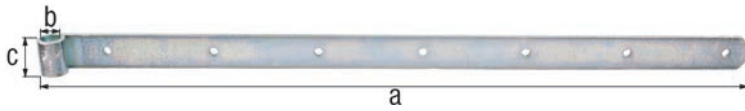

Band hook, straight, rounded

Distance between middle of first drill hole and middle of roller: 50 mm
 Material thickness: 4.00 mm

Accessory note: Suitable fasteners can be found in the range "Screws and accessories".

Dimension a	Dimension b-Ø	Dimension c	UNIT	PU	Contents per PU	Deliv-ery time	Order no. 4004338...
Material: raw steel, Surface: blue galvanised							
300 mm	16 mm	35 mm	6	Piece	-	L	340667
400 mm	16 mm	35 mm	6	Piece	-	L	340681
500 mm	16 mm	35 mm	6	Piece	-	L	340704
600 mm	16 mm	35 mm	6	Piece	-	L	340773
700 mm	16 mm	35 mm	6	Piece	-	L	340797
800 mm	16 mm	35 mm	6	Piece	-	L	340810
Material: raw steel, Surface: yellow galvanised, black powder-coated							
300 mm	16 mm	35 mm	6	Piece	-	L	340674
400 mm	16 mm	35 mm	6	Piece	-	L	340698
500 mm	16 mm	35 mm	6	Piece	-	L	340711
600 mm	16 mm	35 mm	6	Piece	-	L	340780
Material: stainless steel							
VA 300 mm	16 mm	35 mm	6	Piece	-	L	340834
VA 400 mm	16 mm	35 mm	6	Piece	-	L	340841
VA 600 mm	16 mm	35 mm	6	Piece	-	L	340865



Band hook, cranked, rounded

Offset: 15 mm
 Material thickness: 4.00 mm

Accessory note: Suitable fasteners can be found in the range "Screws and accessories".

Dimension a	Dimension b-Ø	Dimension c	UNIT	PU	Contents per PU	Deliv-ery time	Order no. 4004338...
Material: stainless steel							
VA 500 mm	13 mm	40 mm	4	Piece	-	L	318185



Band hook, cranked, rounded

Offset: 15 mm
Material thickness: 5.00 mm

Assembly note: With the hook on plate (type DI) the gate closes in alignment with the post!

Accessory note: Suitable fasteners can be found in the range "Screws and accessories".

Dimension a	Dimension b-Ø	Dimension c	UNIT	PU	Contents per PU	Deliv-ery time	Order no. 4004338...
Material: stainless steel							
704 mm	16 mm	45 mm	4	Piece	-	L	318208 VA

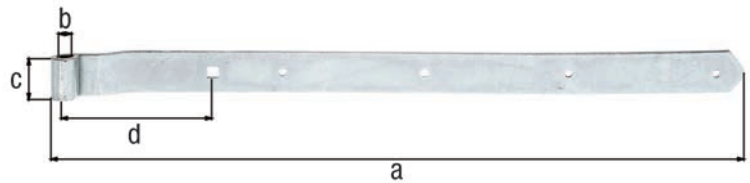

Band hook, cranked, rounded

Offset: 15 mm
Material thickness: 5.00 mm

Assembly note: With the hook on plate (type DI) the gate closes in alignment with the post!

Accessory note: Suitable fasteners can be found in the range "Screws and accessories".

Dimension a	Dimension b-Ø	Dimension c	Dimension d	UNIT	PU	Contents per PU	Deliv-ery time	Order no. 4004338...
Material: raw steel, Surface: galvanised, thick-film passivated								
642 mm	13 mm	40 mm	135 mm	6	Piece	-	L	318406
783.5 mm	16 mm	40 mm	135 mm	6	Piece	-	L	318413

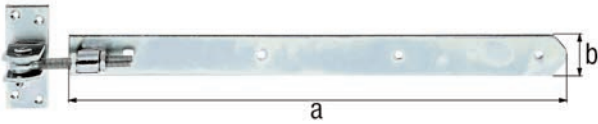

Band hook, straight, rounded

can be adjusted by: 30 mm
Material thickness: 5.00 mm

- The band hook allows the gate to be adjusted after it has been mounted.

Accessory note: Screw-on hooks included.
Suitable fasteners can be found in the range “Screws and accessories”.

Dimension a	Dimension b	Thread	UNIT	PU	Contents per PU	Deliv-ery time	Order no. 4004338...
Material: raw steel, Surface: galvanised, thick-film passivated							
463 mm	40 mm	M12	6	Piece	-	L	318253
660 mm	40 mm	M16	4	Piece	-	L	318260
Material: raw steel, Surface: blue galvanised							
463 mm	40 mm	M12	6	Piece	-	L	318321
660 mm	40 mm	M16	4	Piece	-	L	318338
Material: raw steel, Surface: hot-dip galvanised							
463 mm	40 mm	M12	6	Piece	-	L	318277
660 mm	40 mm	M16	4	Piece	-	L	318284

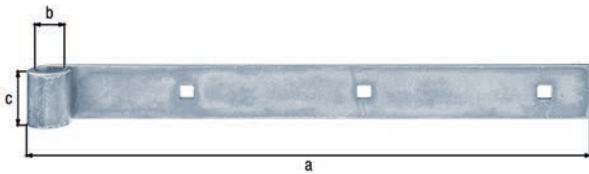

Band hook, straight, straight end

Dimension a	Dimension b-Ø	Dimension c	UNIT	PU	Contents per PU	Deliv-ery time	Order no. 4004338...
Material: raw steel, Surface: blue galvanised							
300 mm	14 mm	35 mm	10	Piece	-	L	308766
400 mm	14 mm	30 mm	10	Piece	-	L	308568
400 mm	14 mm	35 mm	10	Piece	-	L	306106
500 mm	14 mm	35 mm	10	Piece	-	L	306113
600 mm	14 mm	35 mm	10	Piece	-	L	306120
700 mm	14 mm	35 mm	10	Piece	-	L	308599
800 mm	14 mm	35 mm	10	Piece	-	L	306137
Material: raw steel, Surface: black powder-coated							
300 mm	14 mm	30 mm	10	Piece	-	L	308506
300 mm	14 mm	35 mm	10	Piece	-	L	306038
400 mm	14 mm	30 mm	10	Piece	-	L	308513
400 mm	14 mm	35 mm	10	Piece	-	L	306045
500 mm	14 mm	35 mm	10	Piece	-	L	306052
600 mm	14 mm	35 mm	10	Piece	-	L	306069
700 mm	14 mm	35 mm	10	Piece	-	L	308544
800 mm	14 mm	35 mm	6	Piece	-	L	308551

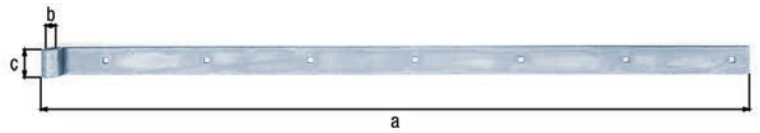

Band hook, straight, straight end

Material thickness: 5.00 mm

Dimension a	Dimension b-Ø	Dimension c	UNIT	PU	Contents per PU	Deliv-ery time	Order no. 4004338...
Material: raw steel, Surface: blue galvanised							
1000 mm	16 mm	40 mm	4	Piece	-	L	308735
1160 mm	16 mm	40 mm	4	Piece	-	L	308742
Material: raw steel, Surface: black powder-coated							
1000 mm	16 mm	40 mm	4	Piece	-	L	306083
1160 mm	16 mm	40 mm	4	Piece	-	L	306090

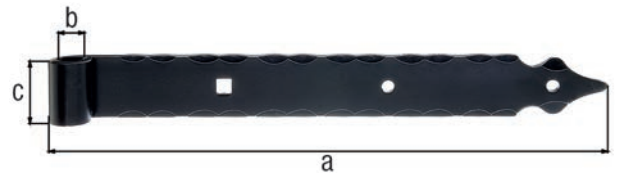

Band hook, straight, with decorative final

Type: hammered

Material thickness: 6.00 mm

Accessory note: Suitable fasteners can be found in the range "Screws and accessories".

Dimension a	Dimension b-Ø	Dimension c	UNIT	PU	Contents per PU	Deliv-ery time	Order no. 4004338...
Material: raw steel, Surface: galvanised, black powder-coated							
400 mm	16 mm	45 mm	2	Bag	-	L	320300
600 mm	16 mm	45 mm	2	Bag	-	L	320355
820 mm	16 mm	45 mm	2	Bag	-	L	320409

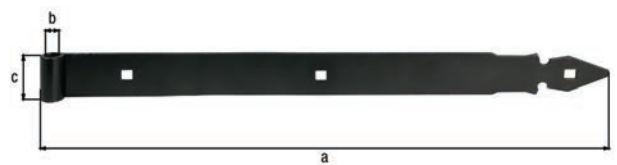

Band hook, straight, with decorative final

Material thickness: 4.00 mm

Dimension a	Dimension b-Ø	Dimension c	UNIT	PU	Contents per PU	Deliv-ery time	Order no. 4004338...
Material: raw steel, Surface: wet paint application, black							
395 mm	14.5 mm	45 mm	6	Piece	-	L	323509
495 mm	14.5 mm	45 mm	6	Piece	-	L	323530
595 mm	14.5 mm	45 mm	5	Piece	-	L	323516



Band hook, straight, with decorative final

Dimension a	Dimension b-Ø	Dimension c	Material thickness	UNIT	PU	Contents per PU	Deliv-ery time	Order no. 4004338...
Material: raw steel, Surface: wet paint application, black								
295 mm	14.5 mm	30 mm	4.00 mm	4	Piece	-	L	323523
395 mm	14.5 mm	30 mm	5.00 mm	4	Piece	-	L	323561

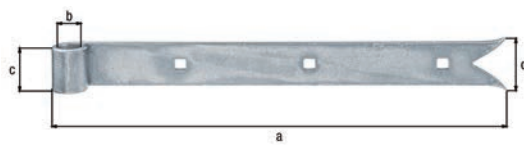

Band hook, straight, decorative final

Dimension a	Dimension b-Ø	Dimension c	Dimension d	Material thickness	UNIT	PU	Contents per PU	Deliv-ery time	Order no. 4004338...
Material: raw steel, Surface: blue galvanised									
400 mm	14 mm	35 mm	56 mm	5.00 mm	10	Piece	-	L	308780
500 mm	14 mm	35 mm	45 mm	5.00 mm	10	Piece	-	L	306229
600 mm	14 mm	35 mm	45 mm	5.00 mm	10	Piece	-	L	306236
700 mm	14 mm	35 mm	45 mm	5.00 mm	10	Piece	-	L	306243
800 mm	14 mm	35 mm	45 mm	5.00 mm	10	Piece	-	L	306250
Material: raw steel, Surface: black powder-coated									
300 mm	14 mm	35 mm	47 mm	5.00 mm	10	Piece	-	L	306144
400 mm	14 mm	35 mm	47 mm	5.00 mm	10	Piece	-	L	306151
500 mm	14 mm	35 mm	45 mm	5.00 mm	10	Piece	-	L	306168
600 mm	14 mm	35 mm	47 mm	5.00 mm	10	Piece	-	L	306175
700 mm	14 mm	35 mm	45 mm	5.00 mm	10	Piece	-	L	306182
800 mm	14 mm	35 mm	47 mm	5.00 mm	6	Piece	-	L	306199

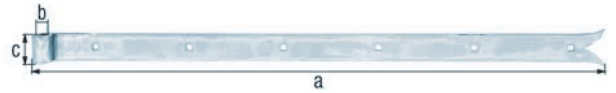

Band hook, straight, decorative final

Material thickness: 5.00 mm

Dimension a	Dimension b-Ø	Dimension c	Dimension d	UNIT	PU	Contents per PU	Delivery time	Order no. 4004338...
Material: raw steel, Surface: blue galvanised								
1000 mm	16 mm	40 mm	55 mm	4	Piece	-	L	308704
1160 mm	16 mm	40 mm	57 mm	4	Piece	-	L	308711
Material: raw steel, Surface: black powder-coated								
1000 mm	16 mm	40 mm	55 mm	4	Piece	-	L	306212
1160 mm	16 mm	40 mm	57 mm	4	Piece	-	L	308728

Gate middle hinge, straight, pointed end

for frame gates

Width of the roller: 40 mm
 Roller thickness: 5 mm
 Material thickness: 5.00 mm

Assembly note: Description at top/bottom applies to the left gate leaf. The bands on the right gate leaf must be replaced.

Accessory note: Suitable fasteners can be found in the range "Screws and accessories".

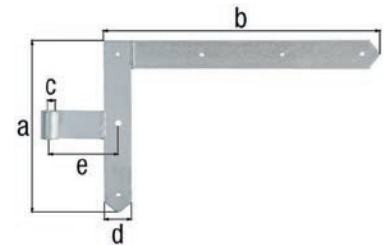

Fig. Top version

Item description	Dimension a	Dimension b	Dimension c-Ø	Dimension d	Dimension e	UNIT	PU	Contents per PU	Delivery time	Order no. 4004338...
Material: raw steel, Surface: hot-dip galvanised										
Top	250 mm	400 mm	13 mm	40 mm	100 mm	1	Piece	-	L	313166
Bottom	250 mm	400 mm	13 mm	40 mm	100 mm	1	Piece	-	L	313173

Gate middle hinge, straight, pointed end

Width of the roller: 40 mm
 Roller thickness: 5 mm
 Material thickness: 5.00 mm

Accessory note: Suitable fasteners can be found in the range "Screws and accessories".

Item description	Dimension a	Dimension b	Dimension c-Ø	Dimension d	Dimension e	UNIT	PU	Contents per PU	Delivery time	Order no. 4004338...
Material: raw steel, Surface: galvanised, thick-film passivated										
Top	400 mm	600 mm	16 mm	40 mm	105 mm	1	Piece	-	L	313104
Bottom	400 mm	600 mm	16 mm	40 mm	105 mm	1	Piece	-	L	313111
Top	400 mm	800 mm	16 mm	40 mm	105 mm	1	Piece	-	L	313128
Bottom	400 mm	800 mm	16 mm	40 mm	105 mm	1	Piece	-	L	313135

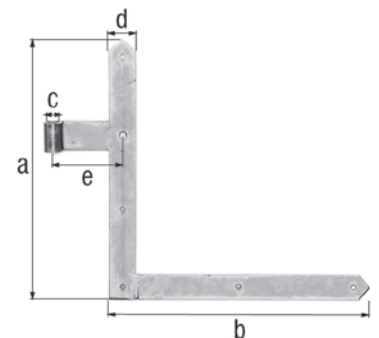
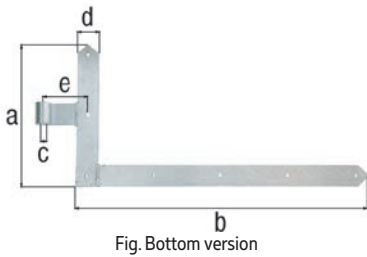

Fig. Bottom version



Gate middle hinge, straight, pointed end

for garage doors

Width of the roller: 60 mm
 Roller thickness: 8 mm
 Material thickness: 8.00 mm

Accessory note: Suitable fasteners can be found in the range "Screws and accessories".

Item description	Dimension a	Dimension b	Dimension c-Ø	Dimension d	Dimension e	UNIT	PU	Contents per PU	Deliv-ery time	Order no. 4004338...
Material: raw steel, Surface: hot-dip galvanised										
Top	600 mm	1000 mm	20 mm	60 mm	120 mm	1	Piece	-	L	312947
Bottom	600 mm	1000 mm	20 mm	60 mm	120 mm	1	Piece	-	L	312978

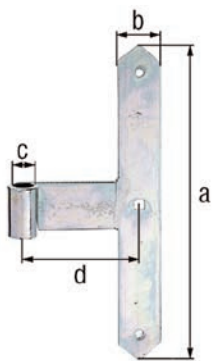

Gate middle hinge, straight, pointed end

Type: light
 Material thickness: 5.00 mm

Accessory note: Suitable fasteners can be found in the range "Screws and accessories".

Dimension a	Dimension b	Dimension c-Ø	Dimension d	UNIT	PU	Contents per PU	Deliv-ery time	Order no. 4004338...
Material: raw steel, Surface: galvanised, thick-film passivated								
300 mm	40 mm	16 mm	105 mm	5	Piece	-	L	312909
Material: raw steel, Surface: hot-dip galvanised								
300 mm	40 mm	16 mm	105 mm	5	Piece	-	L	312893

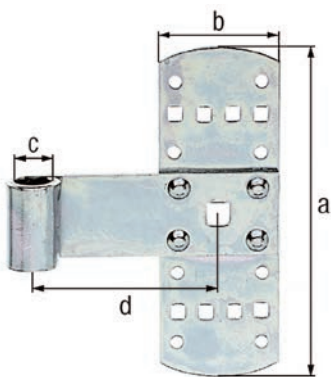

Tee hinge

Width of the roller: 35 mm
 Roller thickness: 4 mm

Accessory note: Suitable fasteners can be found in the range "Screws and accessories".

Dimension a	Dimension b	Dimension c-Ø	Dimension d	UNIT	PU	Contents per PU	Deliv-ery time	Order no. 4004338...
Material: raw steel, Surface: galvanised, thick-film passivated								
140 mm	50 mm	13 mm	75 mm	10	Piece	-	L	314996
160 mm	50 mm	13 mm	75 mm	6	Piece	-	L	315047
Material: raw steel, Surface: blue galvanised								
140 mm	50 mm	16 mm	75 mm	10	Piece	-	L	315016
180 mm	30 mm	16 mm	85 mm	6	Piece	-	L	315023
Material: raw steel, Surface: black cataphoretic coating								
180 mm	30 mm	16 mm	85 mm	6	Piece	-	L	315009

Hook and eye

with angle counter plates

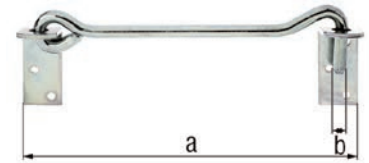

Dimension a	Dimension b-Ø	UNIT	PU	Contents per PU	Deliv-ery time	Order no. 4004338...
Material: raw steel, Surface: galvanised, thick-film passivated, for screwing on						
200 mm	8 mm	10	Piece	-	L	209209
280 mm	12 mm	10	Piece	-	L	209216
590 mm	12 mm	1	Piece	-	L	209223

Hook and eye

with eyes on plates
with countersunk screw holes

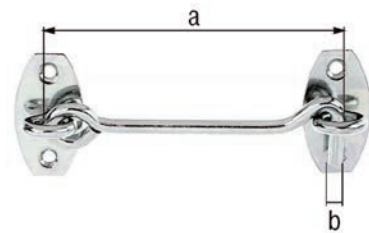

Dimension a	Dimension b-Ø	UNIT	PU	Contents per PU	Deliv-ery time	Order no. 4004338...
Material: raw steel, Surface: galvanised, thick-film passivated, for screwing on						
100 mm	5.2 mm	6	Card	1 Piece	L	903848
120 mm	5.8 mm	6	Card	1 Piece	L	903855
120 mm	5.8 mm	6	Card	1 Piece	L	903855

Hook and eye

with eyes

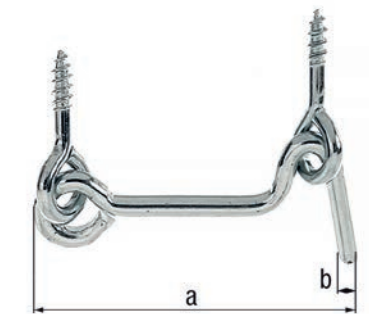

Dimension a	Dimension b-Ø	UNIT	PU	Contents per PU	Deliv-ery time	Order no. 4004338...
Material: raw steel, Surface: blue galvanised, for screwing in						
50 mm	3 mm	10	Piece	-	L	204433
76 mm	4 mm	10	Piece	-	L	204440
120 mm	4 mm	10	Piece	-	L	204457
157 mm	5 mm	10	Piece	-	L	204464
198 mm	6 mm	10	Piece	-	L	204471
250 mm	7 mm	10	Piece	-	L	204488

Hook and eye

with eyes

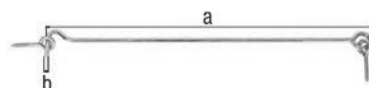

Dimension a	Dimension b-Ø	UNIT	PU	Contents per PU	Deliv-ery time	Order no. 4004338...
Material: raw steel, Surface: galvanised, thick-film passivated, for screwing in						
400 mm	6 mm	10	Piece	-	L	209230
Material: raw steel, Surface: blue galvanised, for screwing in						
300 mm	5 mm	10	Piece	-	L	903879
400 mm	6 mm	10	Piece	-	L	209384
500 mm	6 mm	10	Piece	-	L	204143



Hook and eye

with eyes

Dimension a	Dimension b-Ø	UNIT	PU	Contents per PU	Deliv-ery time	Order no. 4004338...
Material: raw steel, Surface: galvanised, thick-film passivated, for screwing in						
60 mm	4 mm	10	Card	1 Piece	L	903800
80 mm	4 mm	10	Card	1 Piece	L	903817
100 mm	4 mm	10	Card	1 Piece	L	903824
Material: raw steel, Surface: blue galvanised, for screwing in						
60 mm	4 mm	10	Piece	-	L	903886

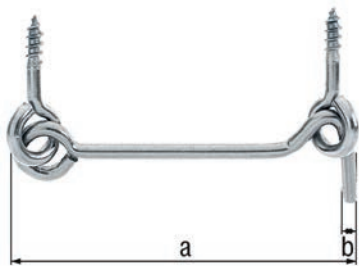

Hook and eye

with eyes

Dimension a	Dimension b-Ø	UNIT	PU	Contents per PU	Deliv-ery time	Order no. 4004338...
Material: stainless steel, for screwing in						
100 mm	3 mm	20	Piece	-	L	204150
120 mm	4.2 mm	20	Piece	-	L	209193
160 mm	3.5 mm	10	Piece	-	L	204167
200 mm	6 mm	10	Piece	-	L	903862

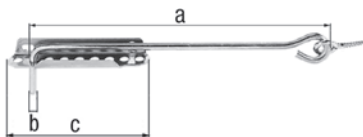

Hook and eye

with fixing plate

makes it possible to fix the gate in different positions

Dimension a	Dimension b-Ø	Dimension c	UNIT	PU	Contents per PU	Deliv-ery time	Order no. 4004338...
Material: raw steel, Surface: blue galvanised, for screwing in							
300 mm	8 mm	140 mm	12	Piece	-	L	204174
400 mm	8 mm	140 mm	12	Piece	-	L	204181
500 mm	8 mm	140 mm	12	Piece	-	L	204280
600 mm	8 mm	140 mm	12	Piece	-	L	204297
Material: raw steel, Surface: black cataphoretic coating, for screwing in							
300 mm	8 mm	140 mm	12	Piece	-	L	204228
400 mm	8 mm	140 mm	12	Piece	-	L	204242
500 mm	8 mm	140 mm	12	Piece	-	L	204266
600 mm	8 mm	140 mm	12	Piece	-	L	204273

Sash look box

suitable for key nos. 214791, 214807, 214814, 214821, 214838 and 214784
 perforation for warded lock
 with lifting latch
 applicable DIN left and right
 2-level
 Bolt recess: 14 / 28 mm
 Socket: 8 x 8 mm

Accessory note: Stop, handle, narrow lock case, long plate and one key included.

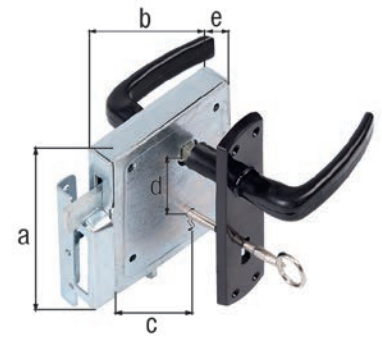

Item description	Dimension a	Dimension b	Dimension c	Dimension d	Dimension e	UNIT	PU	Contents per PU	Delivery time	Order no. 4004338...
Material: raw steel, Surface: blue galvanised										
With night lock, perforation for warded lock	118 mm	100 mm	60 mm	55 mm	20 mm	1	Piece	-	L	214845

Sash look box

suitable for key nos. 216924, 216931, 216948, 216979, 216993, 216986
 perforation for warded lock
 with lifting latch
 applicable DIN left and right
 2-level
 Bolt recess: 12 / 24 mm
 Socket: 8 x 8 mm

Accessory note: Stop, handle, narrow lock case, long plate and one key included.

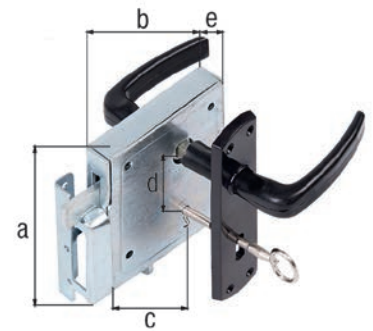

Item description	Dimension a	Dimension b	Dimension c	Dimension d	Dimension e	UNIT	PU	Contents per PU	Delivery time	Order no. 4004338...
Material: raw steel, Surface: blue galvanised										
With night lock, perforation for warded lock	100 mm	105 mm	60 mm	51 mm	22 mm	5	Card	1 Piece	L	901554

Key for box locks

suitable for box locks

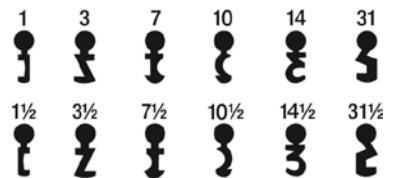

Upsweep	UNIT	PU	Contents per PU	Delivery time	Order no. 4004338...
Material: die-cast zinc					
1	1	Piece	-	L	214784
3	1	Piece	-	L	216986
7	1	Piece	-	L	216979
10	1	Piece	-	L	214807
14	1	Piece	-	L	214821
31	1	Piece	-	L	216948
11/2	1	Piece	-	L	214791
31/2	1	Piece	-	L	216931
71/2	1	Piece	-	L	216924
10 1/2	1	Piece	-	S	214814
14 1/2	1	Piece	-	L	214838
31 1/2	1	Piece	-	L	216993

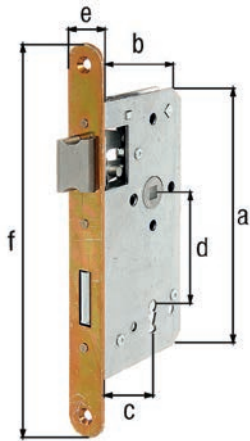

Deadbolt lock especially for frame gates

Heavy, stable design for use outdoors.
 All inner parts are galvanised to protect against rust.
 with countersunk screw holes

perforation for warded lock
 without locking plate
 applicable DIN left and right
 without switch-over
 2-level
 foldable latch
 rounded strike plate
 Bolt recess: 13 / 25 mm
 Socket: 8 x 8 mm

Dimension a	Dimension b	Dimension c	Dimension d	Dimension e	Dimension f	UNIT	PU	Contents per PU	Deliv-ery time	Order no. 4004338...
167 mm	85 mm	55 mm	72 mm	24 mm	235 mm	1	Piece	-	L	215200

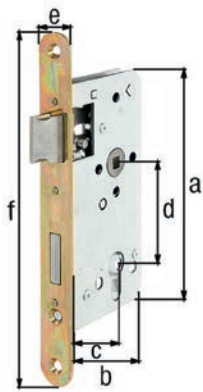

Deadbolt lock especially for frame gates

Heavy, stable design for use outdoors.
 All inner parts are galvanised to protect against rust.
 with countersunk screw holes

applicable DIN left and right
 PC perforation
 with switch-over
 2-level
 foldable latch
 rounded strike plate
 Bolt recess: 13 / 25 mm
 Socket: 8 x 8 mm

Dimension a	Dimension b	Dimension c	Dimension d	Dimension e	Dimension f	UNIT	PU	Contents per PU	Deliv-ery time	Order no. 4004338...
167 mm	85 mm	55 mm	72 mm	24 mm	235 mm	1	Piece	-	L	215224
167 mm	85 mm	55 mm	72 mm	24 mm	235 mm	1	Piece	-	L	215231

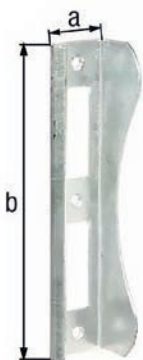

Stop for gates with deadbolt lock

applicable DIN left and right
 for fastening to wall columns or timber posts
 For frame thickness of: 37 mm

- Reliable function even if the gate has been affected by harsh weather conditions.

Dimension a	Dimension b	UNIT	PU	Contents per PU	Deliv-ery time	Order no. 4004338...
37 mm	181 mm	1	Piece	-	L	215378
37 mm	181 mm	1	Piece	-	L	215361

Door handle for deadbolt locks

Accessory note: 8 x 8 mm square pin and long plate with 72 mm distance included.

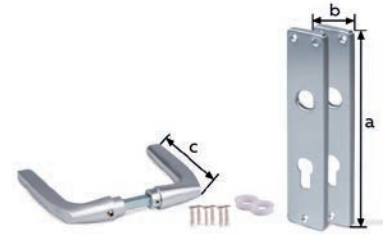

Item description	Dimension a	Dimension b	Dimension c	UNIT	PU	Contents per PU	Deliv-ery time	Order no. 4004338...
Material: aluminium, Surface: silver anodised								
one pair, perforation PC	220 mm	40 mm	124 mm	10	Pair	-	L	215668

Woven fence fastening latch for single gates

usable with left and right stop
closing option using security hasp number 210458

Set components: One set consists of one set of handles with rosettes and a special bolt latch and stop hook

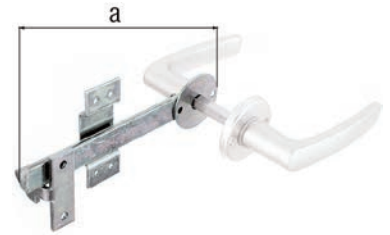

Dimension a	UNIT	PU	Contents per PU	Deliv-ery time	Order no. 4004338...
Material: raw steel, Surface: galvanised, thick-film passivated, handle and rosette: aluminium, packaged in a set					
170 mm	1	Piece	-	L	213565
Material: raw steel, Surface: blue galvanised, handle and rosette: aluminium, packaged in a set					
170 mm	1	Piece	-	L	213053

Latch set for woven fence gates and light wooden gates

Set components: One set consists of one handle, lever, cramp and hook. The cramp and hook are for driving in

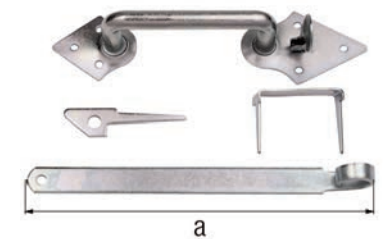

Dimension a	UNIT	PU	Contents per PU	Deliv-ery time	Order no. 4004338...
Material: raw steel, Surface: galvanised, thick-film passivated, for driving in					
260 mm	5	Piece	-	L	310332

Latch set for woven fence gates and light wooden gates

Set components: One set consists of one handle, lever, cramp and hook. The cramp and hook are for screwing on

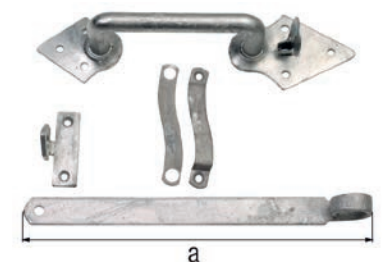

Dimension a	UNIT	PU	Contents per PU	Deliv-ery time	Order no. 4004338...
Material: raw steel, Surface: hot-dip galvanised, for screwing on					
260 mm	5	Piece	-	L	310387

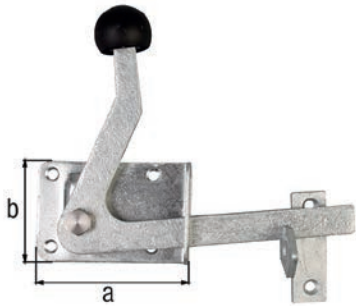

Fig. Version right

Garden gate latch

with countersunk screw holes
with door latch

applicable for left and right stop by turning the bolt height adjustable after installation by loosening the screw

Dimension a	Dimension b	UNIT	PU	Contents per PU	Deliv-ery time	Order no. 4004338...
Material: raw steel, Surface: hot-dip galvanised						
80 mm	55 mm	5	Piece	-	L	210120
Material: stainless steel, additionally shot blasted						
80 mm	55 mm	5	Piece	-	L	326005

VA

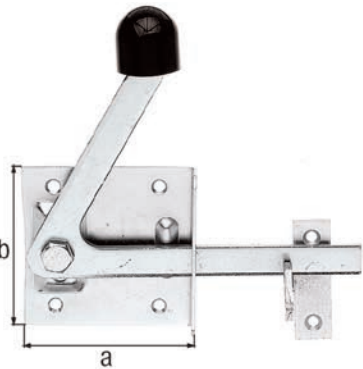

Fig. Version right

Garden gate latch

with countersunk screw holes
with door latch

applicable for left and right stop by turning the bolt height adjustable after installation by loosening the screw

Dimension a	Dimension b	UNIT	PU	Contents per PU	Deliv-ery time	Order no. 4004338...
Material: raw steel, Surface: galvanised, thick-film passivated						
80 mm	80 mm	5	Piece	-	L	210328

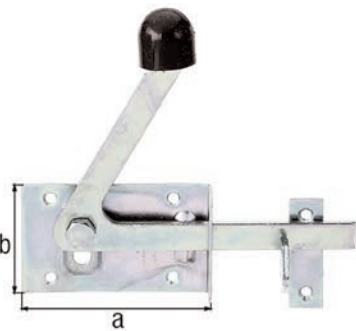

Fig. Version right

Garden gate latch especially for narrow frame timbers

with countersunk screw holes
with door latch

applicable for left and right stop by turning the bolt height adjustable after installation by loosening the screw

Dimension a	Dimension b	UNIT	PU	Contents per PU	Deliv-ery time	Order no. 4004338...
Material: raw steel, Surface: galvanised, thick-film passivated						
100 mm	60 mm	5	Piece	-	L	210397
Material: raw steel, Surface: blue galvanised						
100 mm	60 mm	5	Piece	-	L	210366

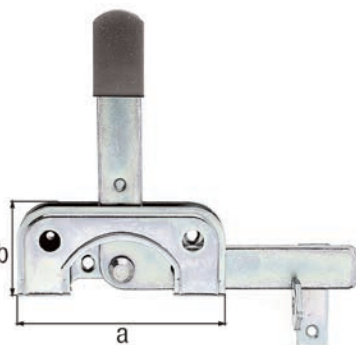

Fig. Version right

Garden gate latch especially for narrow frame timbers

with countersunk screw holes
with door latch

usable with left and right stop by swivelling the bolt and changing the handle cap over

Dimension a	Dimension b	UNIT	PU	Contents per PU	Deliv-ery time	Order no. 4004338...
Material: raw steel, Surface: galvanised, thick-film passivated						
120 mm	50 mm	5	Piece	-	L	209551

Garden gate fastening latch for high gates or woven fence doors

with countersunk screw holes
with door latch

can be opened and closed from inside and outside

Both rotating actuation rings are positioned in rosettes and are connected to each other via a square pin for wood thicknesses of up to 60 mm. The bolt is guided on one side through a guide plate, which is screwed to the gate frame and locked in the hook supplied.

Pin length: 77 mm

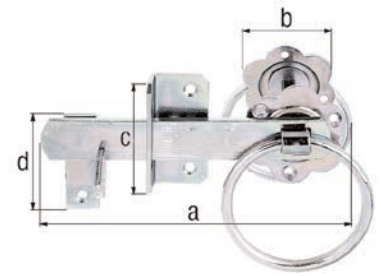

Dimension a	Dimension b-Ø	Dimension c	Dimension d	UNIT	PU	Contents per PU	Delivery time	Order no. 4004338...
Material: raw steel, Surface: galvanised, thick-film passivated								
155 mm	60 mm	70 mm	60 mm	1	Piece	-	L	210250

Garden gate fastening latch

applicable DIN left and right

Dimension a	Dimension b	UNIT	PU	Contents per PU	Delivery time	Order no. 4004338...
Material: raw steel, Surface: blue galvanised						
55 mm	45 mm	10	Piece	-	L	210182
Material: stainless steel						
55 mm	45 mm	5	Piece	-	L	326197 VA

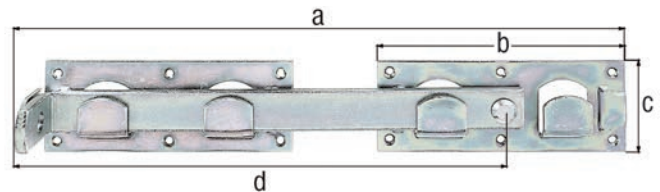
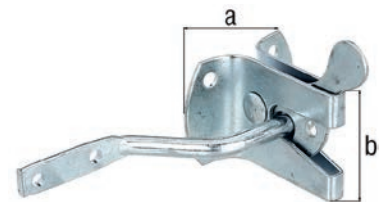

Double gate hasp

with countersunk screw holes

the closing bracket can be used on both sides
applicable DIN left and right
fixation of padlock possible

Accessory note: Padlocks not included.

Dimension a	Dimension b	Dimension c	Dimension d	UNIT	PU	Contents per PU	Delivery time	Order no. 4004338...
Material: raw steel, Surface: galvanised, thick-film passivated, individual parts attached with cable ties								
423 mm	180 mm	70 mm	333 mm	5	Piece	-	L	210625
Material: raw steel, Surface: blue galvanised, individual parts attached with cable ties								
423 mm	180 mm	70 mm	333 mm	5	Piece	-	L	210571
Material: raw steel, Surface: hot-dip galvanised, individual parts attached with cable ties								
430 mm	180 mm	70 mm	333 mm	5	Piece	-	L	210137
Material: raw steel, Surface: black cataphoretic coating, individual parts attached with cable ties								
423 mm	180 mm	70 mm	333 mm	5	Piece	-	L	210205

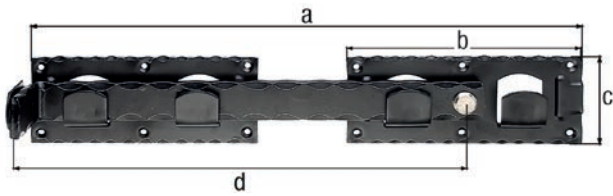

Double gate hasp wrought iron

with countersunk screw holes

applicable DIN left and right
fixation of padlock possible
Type: hammered

Accessory note: Padlocks not included.

Dimension a	Dimension b	Dimension c	Dimension d	UNIT	PU	Contents per PU	Deliv-ery time	Order no. 4004338...
Material: raw steel, Surface: galvanised, black powder-coated								
423 mm	180 mm	70 mm	333 mm	1	Piece	-	L	323011

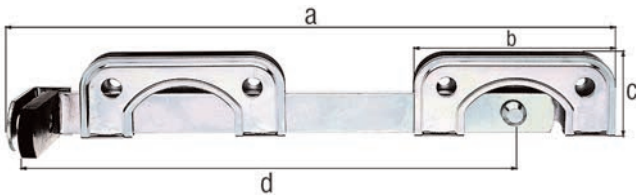

Double gate hasp especially for narrow frame timbers

the closing bracket can be used on both sides
applicable DIN left and right
fixation of padlock possible

Accessory note: Padlocks not included.

Dimension a	Dimension b	Dimension c	Dimension d	UNIT	PU	Contents per PU	Deliv-ery time	Order no. 4004338...
Material: raw steel, Surface: galvanised, thick-film passivated, individual parts attached with cable ties								
335 mm	120 mm	60 mm	275 mm	5	Piece	-	L	209803

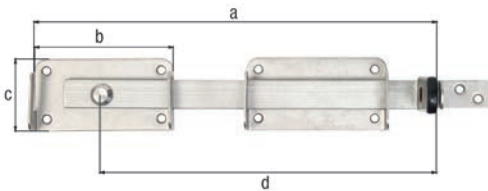

Double gate hasp

the closing bracket can be used on both sides
applicable DIN left and right
fixation of padlock possible

Accessory note: Padlocks not included.

Dimension a	Dimension b	Dimension c	Dimension d	UNIT	PU	Contents per PU	Deliv-ery time	Order no. 4004338...
Material: stainless steel, additionally shot blasted								
327 mm	118 mm	52 mm	268 mm	3	Piece	-	L	326012

VA

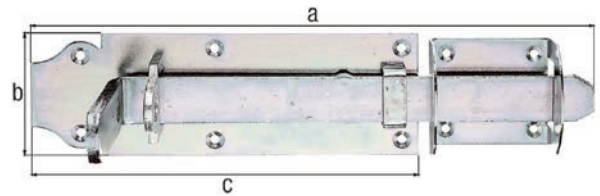

Double gate fastening latch especially for frame gates

with countersunk screw holes

applicable DIN left and right
fixation of padlock possible

Accessory note: Padlocks not included.

Dimension a	Dimension b	Dimension c	UNIT	PU	Contents per PU	Deliv-ery time	Order no. 4004338...
Material: raw steel, Surface: galvanised, thick-film passivated							
380 mm	80 mm	250 mm	5	Piece	-	L	210656

Garden gate fitting set for woven fence single gates

with countersunk screw holes

Set components: One set consists of one garden gate lock, for right and left side use, one safety hasp, two band hooks, 500 mm long, Ø 13 mm roller, two hooks, 13 mm pin, and one set of screws



UNIT	PU	Contents per PU	Delivery time	Order no. 4004338...
Material: raw steel, Surface: galvanised, thick-film passivated				
1	Piece	-	L	206505

Garden gate fitting set for lattice fence single gates

with countersunk screw holes

Set components: One set consists of one garden door latch, two band hooks, 500 mm long, Ø 13 mm roller, two hooks, 13 mm pin, and a set of screws



UNIT	PU	Contents per PU	Delivery time	Order no. 4004338...
Material: raw steel, Surface: galvanised, thick-film passivated				
1	Box	1 Set	L	216511

Garden gate fitting set for lattice fence single gates

with countersunk screw holes

Set components: One set consists of one garden door latch, two band hooks, cranked, 500 mm long, Ø 13 mm roller, two hooks, 13 mm pin, and a set of screws



UNIT	PU	Contents per PU	Delivery time	Order no. 4004338...
Material: stainless steel				
1	Piece	-	L	361495

VA



Garden gate fitting set for single frame gates

with countersunk screw holes

Set components: One set consists of one deadbolt lock, opening direction left and right, one stop, two shutter hinges, 500 mm, Ø 16 mm roller, two hooks, 16 mm pin, and one screw set

UNIT	PU	Contents per PU	Delivery time	Order no. 4004338...
Material: raw steel, Surface: galvanised, thick-film passivated				
1	Piece	-	S	223380



Garden gate fitting set for single sectional gates

with countersunk screw holes

Set components: One set consists of two corner hinges 215 x 112 x 25 mm, Ø 8 mm roller, two hooks to screw on, 8 mm pin, two angled lift-off protectors 16 x 2.5 mm, one gate latch with hook, bracket, bracket guide, handle with guide plates and one screw set

UNIT	PU	Contents per PU	Delivery time	Order no. 4004338...
Material: raw steel, Surface: hot-dip galvanised				
1	Piece	-	S	222277



Garden gate fitting set for round arch single gates

Set components: One set consists of two hooks, one angle bracket curved top and one angle bracket cranked bottom

UNIT	PU	Contents per PU	Delivery time	Order no. 4004338...
Material: raw steel, Surface: blue galvanised, black powder-coated, for right-opening gates				
3	Box	3 Set	L	206574
Material: raw steel, Surface: blue galvanised, black powder-coated, for left-opening gates				
3	Box	3 Set	L	206581

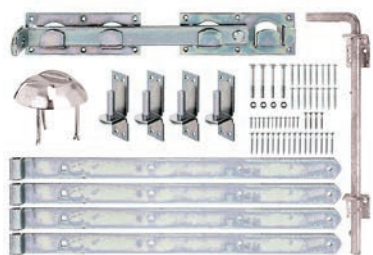

Garden gate fitting set for lattice fence double gates

with countersunk screw holes

Set components: One set consists of one double gate hasp, one drop bolt, 400 mm long, one gate stop, four band hooks, 700 mm long, Ø 16 mm roller, four hooks, 16 mm pin, and a set of screws

UNIT	PU	Contents per PU	Delivery time	Order no. 4004338...
Material: raw steel, Surface: galvanised, thick-film passivated				
1	Piece	-	L	216535

Garden gate fitting set for double gates

with countersunk screw holes

Set components: One set consists of one double gate hasp, one drop bolt, 400 mm long, one gate stop, four band hooks, 700 mm long, Ø 13 mm roller, four hooks, 13 mm pin, and one set of screws



UNIT	PU	Contents per PU	Delivery time	Order no. 4004338...
Material: raw steel, Surface: galvanised, thick-film passivated				
1	Piece	-	S	216474

Drop bolt

with two guide brackets

Assembly note: Put the lower guide onto the bar between the two lugs and screw it on high enough so that its upper lug rests on the lower guide and the bolt end does not extend past the gate when the bar is open.

Dimension a	Dimension b-Ø	Distance bolt - gate	UNIT	PU	Contents per PU	Deliv-ery time	Order no. 4004338...
Material: raw steel, Surface: hot-dip galvanised							
400 mm	16 mm	30 mm	1	Box	-	L	211011
400 mm	16 mm	40 mm	1	Box	-	L	211028
500 mm	16 mm	40 mm	1	Box	-	L	211042
600 mm	16 mm	40 mm	1	Box	-	L	211066

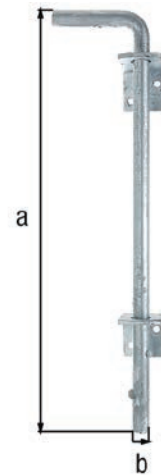

Drop bolt

with countersunk screw holes

with two plastic guides and plastic handle

Dimension a	Dimension b-Ø	Distance bolt - gate	UNIT	PU	Contents per PU	Deliv-ery time	Order no. 4004338...
Material: raw steel, Surface: galvanised, thick-film passivated, guide bracket and handle, fibreglass-reinforced plastic, black							
400 mm	16 mm	40 mm	1	Piece	-	L	207021
600 mm	16 mm	40 mm	1	Piece	-	L	207069
Material: stainless steel, guide bracket and handle: plastic, Surface: grey							
500 mm	16 mm	40 mm	1	Piece	-	L	326029



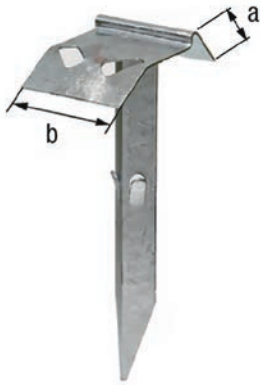

Gate stop

with long holes

for guide height: 30 - 40 mm
Drive-in depth: 370 mm

Dimension a	Dimension b	UNIT	PU	Contents per PU	Deliv-ery time	Order no. 4004338...
47 mm	125 mm	1	Piece	-	L	210854

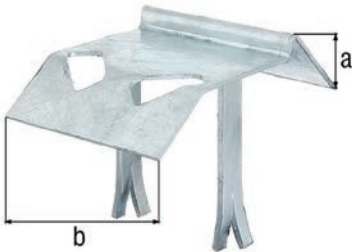

Gate stop

with long holes

for guide height: 30 - 40 mm
depth of encase in concrete: 90 mm

Dimension a	Dimension b	UNIT	PU	Contents per PU	Deliv-ery time	Order no. 4004338...
47 mm	125 mm	1	Piece	-	L	210939

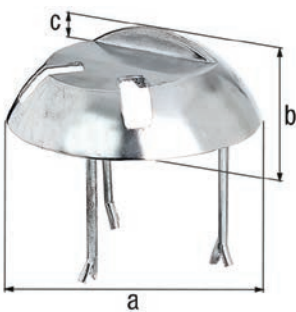

Gate stop

with long holes

for guide height: 50 - 60 mm
depth of encase in concrete: 125 mm

- The rounded form of this gate stop prevents tyres from being damaged when they roll over it.

Accessory note: Three screw-on concrete anchors included.

Dimension a-Ø	Dimension b	Dimension c	UNIT	PU	Contents per PU	Deliv-ery time	Order no. 4004338...
205 mm	65 mm	17 mm	1	Piece	-	L	210953



Gate stop

with long holes

with guide for drop bolt
for guide height: 50 - 80 mm
depth of encase in concrete: 30 mm
Material thickness: 4.00 mm

Dimension a	UNIT	PU	Contents per PU	Deliv-ery time	Order no. 4004338...
100 mm	1	Piece	-	L	137533
100 mm	1	Piece	-	L	137458

Gate stop

with long holes

for guide height: 0 - 15 mm
 depth of encase in concrete: 40 mm
 Material thickness: 2.50 mm

Dimension a	UNIT	PU	Contents per PU	Deliv-ery time	Order no. 4004338...
Material: raw steel, Surface: blue galvanised, for setting in concrete					
50 mm	1	Piece	-	L	137465

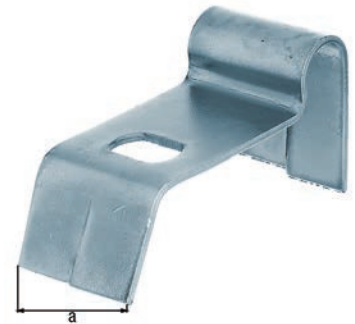

Gate stop

with countersunk screw holes

Type: not drilled
 for guide height: 5 - 35 mm
 Material thickness: 4.00 mm

Dimension a	Dimension b	UNIT	PU	Contents per PU	Deliv-ery time	Order no. 4004338...
Material: raw steel, Surface: black cataphoretic coating, for screwing on						
50 mm	90 mm	1	Piece	-	L	137434



Gate track roller for heavy gates

with rubber roller
 Max. load capacity: 50 kg

Dimension a-Ø	Dimension b	Dimension c	Dimension d	UNIT	PU	Contents per PU	Deliv-ery time	Order no. 4004338...
Material: raw steel, Surface: hot-dip galvanised, for screwing on								
80 mm	110 mm	65 mm	44.5 mm	1	Piece	-	L	214364

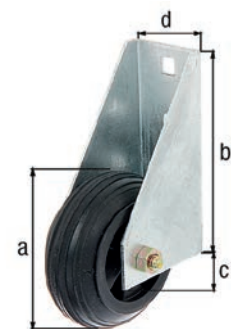

Gate spring

with countersunk screw holes

Dimension a	UNIT	PU	Contents per PU	Deliv-ery time	Order no. 4004338...
Material: raw steel, Surface: blue galvanised, for screwing on					
280 mm	5	Piece	-	L	204808

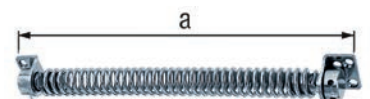

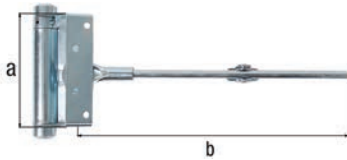

Door and gate bolt

with adjustable spring force
with adjusting pin and adjusting rivet
with guide roller
Type: self-closing
Max. gate weight: 40 kg

Dimension a	Dimension b	UNIT	PU	Contents per PU	Deliv-ery time	Order no. 4004338...
Material: raw steel, Surface: blue galvanised						
100 mm	242 mm	3	Card	1 Piece	L	417758



Lifting gate fitting for wooden gates

for uneven terrain

usable with left and right stop
the gate can open more than 90°
The gate rises when opened. The incline (up to 7°) can be adjusted at different positions and depends on the size of the gate.
load-bearing capacity of 75 kg for a gate width of 1500 mm

Assembly note: A square post at least 80 mm wide is required for assembly.

Set components: One set for a gate leaf consists of one upper and one lower hinge, each 550 mm, one upper screw-on plate 80 x 80 x 7 mm, one lower screw-on plate 100 x 80 x 100 mm, two ball angle joints, greased, galvanised, fixing screws, and assembly instructions. Packed in cardboard box.

UNIT	PU	Contents per PU	Delivery time	Order no. 4004338...
Material: fittings: raw steel, Surface: fittings: hot-dip galvanised, ball angle joint and fastening material: galvanised, for screwing on				
1	Piece	-	L	219611



Lifting gate fitting for wooden gates

for uneven terrain

the gate adapts to the terrain while opening because of the rotatable double hinge
Flat iron: 45 x 6 mm
Castor Ø: 80 mm
Roller dia.: 16 mm

Accessory note: Hooks not included.
Suitable hooks can be ordered separately.

Set components: One set for a gate leaf consists of one pivoting double hinge with roller and one rubber gate wheel

Length	UNIT	PU	Contents per PU	Deliv-ery time	Order no. 4004338...
Material: raw steel, Surface: hot-dip galvanised					
700 mm	1	Piece	-	L	213732

Gate handle

with countersunk screw holes

Dimension a	Dimension b	Material thickness	UNIT	PU	Contents per PU	Delivery time	Order no. 4004338...
Material: raw steel, Surface: galvanised, thick-film passivated							
168 mm	20 mm	3.50 mm	10	Piece	-	L	417901
190 mm	25 mm	5.00 mm	10	Piece	-	L	417918
Material: raw steel, Surface: blue galvanised							
190 mm	25 mm	5.00 mm	10	Piece	-	L	417932
Material: stainless steel							
168 mm	20 mm	3.50 mm	10	Piece	-	L	361440 VA



Gate handle

Type: straight
Handle-Ø: 14 mm

Dimension a	Dimension b	Dimension c	UNIT	PU	Contents per PU	Delivery time	Order no. 4004338...
Material: steel, Surface: black powder-coated							
275 mm	32 mm	60 mm	10	Piece	-	L	419103



Gate handle

with countersunk screw holes

Handle-Ø: 8 mm

Dimension a	Dimension b	UNIT	PU	Contents per PU	Delivery time	Order no. 4004338...
Material: raw steel, Surface: blue galvanised						
159 mm	13 mm	10	Piece	-	L	309558
Material: raw steel, Surface: galvanised, thick-film passivated						
159 mm	13 mm	10	Piece	-	L	307349
Material: raw steel, Surface: blue galvanised, black cataphoretic coating						
159 mm	13 mm	10	Piece	-	L	307332

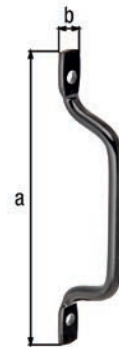

Gate handle

Type: angled
Handle-Ø: 12 mm

Dimension a	Dimension b	UNIT	PU	Contents per PU	Delivery time	Order no. 4004338...
Material: raw steel, Surface: blue galvanised						
120 mm	75 mm	10	Piece	-	L	307646

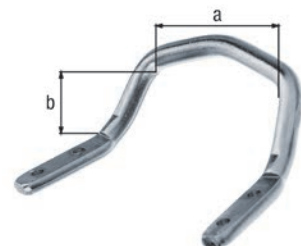

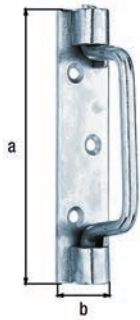

Gate handle, type St. Etienne

with countersunk screw holes

Handle-Ø: 7 mm

Dimension a	Dimension b	UNIT	PU	Contents per PU	Deliv-ery time	Order no. 4004338...
Material: raw steel, Surface: blue galvanised						
127 mm	30 mm	10	Piece	-	L	307615
142 mm	30 mm	10	Piece	-	L	307622
160 mm	30 mm	10	Piece	-	L	307639
Material: raw steel, Surface: black cataphoretic coating						
127 mm	30 mm	10	Piece	-	L	307455
142 mm	30 mm	10	Piece	-	L	307462
160 mm	30 mm	10	Piece	-	L	307479

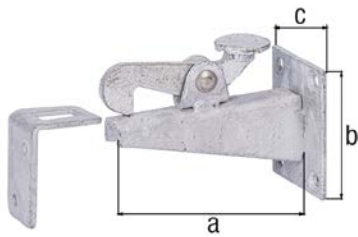

Gate stop for fixing on the wall

with countersunk screw holes

with counter plate

Dimension a	Dimension b	Dimension c	UNIT	PU	Contents per PU	Deliv-ery time	Order no. 4004338...
Material: raw steel, Surface: hot-dip galvanised, for screwing on							
100 mm	65 mm	50 mm	1	Piece	-	L	411756

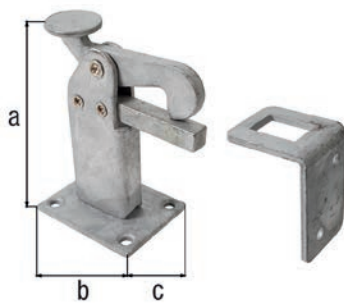

Gate stop for fixing on the ground

with countersunk screw holes

with counter plate

Dimension a	Dimension b	Dimension c	UNIT	PU	Contents per PU	Deliv-ery time	Order no. 4004338...
Material: raw steel, Surface: hot-dip galvanised, for screwing on							
95 mm	65 mm	50 mm	1	Piece	-	L	411763

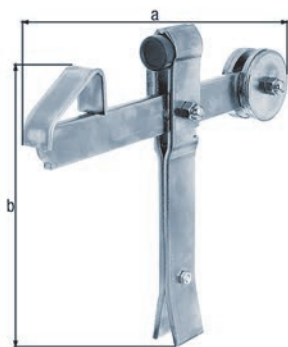

Gate stop with rocker

adjustable from: 45 - 80 mm

Dimension a	Dimension b	UNIT	PU	Contents per PU	Deliv-ery time	Order no. 4004338...
Material: raw steel, Surface: blue galvanised, for setting in concrete						
300 mm	240 mm	1	Piece	-	L	137496
Material: raw steel, Surface: black cataphoretic coating, for setting in concrete						
300 mm	240 mm	1	Piece	-	L	137472

Gate stop with spring

adjustable from: 50 - 90 mm

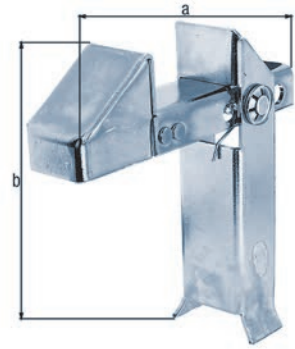

Dimension a	Dimension b	UNIT	PU	Contents per PU	Deliv-ery time	Order no. 4004338...
Material: raw steel, Surface: blue galvanised, for setting in concrete						
185 mm	200 mm	1	Piece	-	L	137502
Material: raw steel, Surface: black cataphoretic coating, for setting in concrete						
185 mm	200 mm	1	Piece	-	L	137519

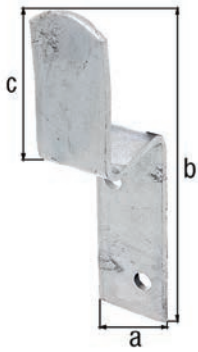

Fence rail connector

for hanging gates and fence panels
for traverses up to 40 mm thick
Material thickness: 4.00 mm

Dimension a	Dimension b	Dimension c	UNIT	PU	Contents per PU	Deliv-ery time	Order no.
Material: raw steel, Surface: hot-dip galvanised							
34 mm	160 mm	66 mm	10	Piece	-	L	210694

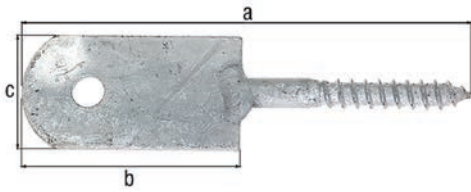

Fence rail connector

for easily fixing fences to timber posts
Material thickness: 4.00 mm
Wooden thread \varnothing : 8 x 60 mm

Assembly note: Holes with \varnothing 6 mm must be predrilled in the timber post before the fence bracket can be installed.

Dimension a	Dimension b	Dimension c	UNIT	PU	Contents per PU	Deliv-ery time	Order no.
Material: raw steel, Surface: hot-dip galvanised, for screwing on							
120 mm	60 mm	30 mm	20	Piece	-	L	210731

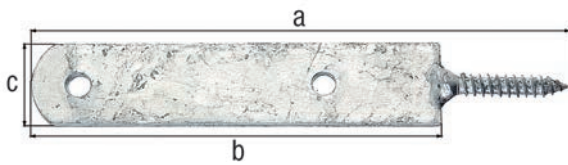

Fence rail connector

for easily fixing fences to timber posts
Material thickness: 4.00 mm
Wooden thread \varnothing : 8 x 60 mm

Assembly note: Holes with \varnothing 6 mm must be predrilled in the timber post before the fence bracket can be installed.

Dimension a	Dimension b	Dimension c	UNIT	PU	Contents per PU	Deliv-ery time	Order no.
Material: raw steel, Surface: hot-dip galvanised, for screwing on							
210 mm	150 mm	30 mm	10	Piece	-	L	210779

Angle

for fixing pergolas etc.
Material thickness: 3.50 mm

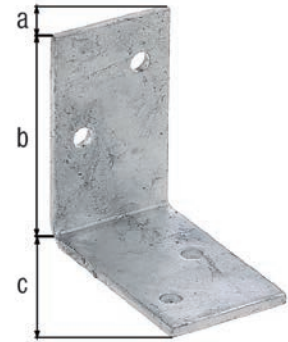

Dimension a	Dimension b	Dimension c	UNIT	PU	Contents per PU	Deliv-ery time	Order no. 4004338...
Material: raw steel, Surface: hot-dip galvanised							
40 mm	70 mm	70 mm	10	Piece	-	L	213244

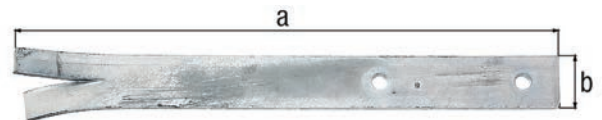

Fence rail connector

for fixing fence traverses to wall columns or masonry
Material thickness: 5.00 mm

Dimension a	Dimension b	UNIT	PU	Contents per PU	Deliv-ery time	Order no. 4004338...
Material: raw steel, Surface: hot-dip galvanised, for setting in concrete						
300 mm	30 mm	10	Piece	-	L	213008

Fence post made of T-profile

for fixing transverse rails
Material thickness: 5.00 mm

Assembly note: The plates for fixing the traverse rails are struck onto the T-iron post at the required height and wedged in by screwing on the traverse rail.

Accessory note: Two plates no. 211561 included.



Dimension a	Dimension b	Length	UNIT	PU	Contents per PU	Deliv-ery time	Order no. 4004338...
Material: raw steel, Surface: hot-dip galvanised passivated							
40 mm	40 mm	1200 mm	1	Piece	-	L	212438

Clip for fence post made of T-profile

suitable for fence post no. 212421f.
Material thickness: 3.00 mm

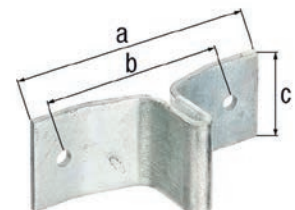

Dimension a	Dimension b	Dimension c	UNIT	PU	Contents per PU	Deliv-ery time	Order no. 4004338...
Material: raw steel, Surface: hot-dip galvanised							
114 mm	85 mm	40 mm	10	Piece	-	L	211554
148 mm	108 mm	40 mm	10	Piece	-	L	211561

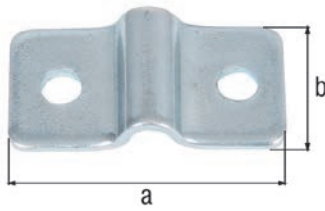

Fixing plate

Material thickness: 2.00 mm

Dimension a	Dimension b	UNIT	PU	Contents per PU	Deliv-ery time	Order no. 4004338...
Material: raw steel, Surface: blue galvanised						
40 mm	20 mm	50	Bag	4 Piece	L	213312

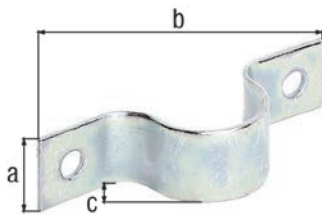

Tube clip

suitable for fastening fence posts to walls, L blocks, etc.

Dimension a	Dimension b	Dimension c	For tube-Ø	For tube-Ø	Material thickness	UNIT	PU	Contents per PU	Deliv-ery time	Order no. 4004338...
Material: raw steel, Surface: galvanised, thick-film passivated										
20 mm	79.0 mm	19.0 mm	19 mm	3/4 Inch	2.00 mm	20	Piece	-	L	216627
20 mm	86.5 mm	24.0 mm	25 mm	1 Inch	2.00 mm	20	Piece	-	L	216634
25 mm	107.0 mm	32.0 mm	31.8 mm	1 1/4 Inch	3.00 mm	20	Piece	-	L	216641
40 mm	104.0 mm	39.5 mm	42.4 mm	1 2/3 Inch	3.00 mm	10	Piece	-	L	216658
40 mm	119.0 mm	44.0 mm	44.5 mm	1 3/4 Inch	3.00 mm	10	Piece	-	L	216665
40 mm	133.0 mm	55.0 mm	57 mm	2 1/4 Inch	3.00 mm	10	Piece	-	L	216672
Material: raw steel, Surface: blue galvanised										
20 mm	86.5 mm	24.0 mm	25 mm	1 Inch	2.00 mm	20	Piece	-	L	216559
25 mm	107.0 mm	32.0 mm	31.8 mm	1 1/4 Inch	3.00 mm	20	Piece	-	L	216573
40 mm	119.0 mm	44.0 mm	44.5 mm	1 3/4 Inch	3.00 mm	10	Piece	-	L	216610

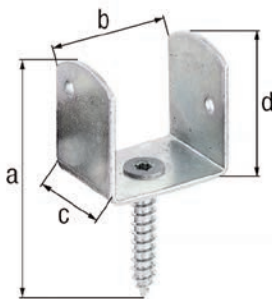

Fence bracket U shape

with wood screw
 Drive: hexagon head (star) size 30
 Material thickness: 2.00 mm
 Wooden thread Ø: 8 x 45 mm

Assembly note: Holes with Ø 6 mm must be predrilled in the timber post before the fence bracket can be installed.

Dimension a	Dimension b	Dimension c	Dimension d	UNIT	PU	Contents per PU	Deliv-ery time	Order no. 4004338...
Material: raw steel, Surface: galvanised, thick-film passivated								
83 mm	38 mm	30 mm	38 mm	100	Piece	-	L	213374

Fence bracket L shape

with wood screw
 Wooden thread Ø: 8 x 45 mm
 Drive: hexagon head (star) size 30
 Material thickness: 2.00 mm

Assembly note: Holes with Ø 6 mm must be predrilled in the timber post before the fence bracket can be installed.

Accessory note: For easy fixation and adjustment use our drive-in tool for fence bracket no. 208790

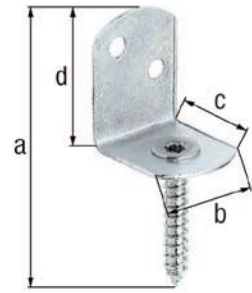

Dimension a	Dimension b	Dimension c	Dimension d	UNIT	PU	Contents per PU	Deliv-ery time	Order no. 4004338...	
Material: raw steel, Surface: galvanised, thick-film passivated									
83 mm	30 mm	32 mm	38 mm	50	Piece	-	L	213442	
83 mm	30 mm	32 mm	38 mm	20	Card	4 Piece	L	213466 GP	
83 mm	30 mm	32 mm	38 mm	6	Pack	24 Piece	L	212209 GP	
Material: raw steel, Surface: blue galvanised									
83 mm	32 mm	30 mm	38 mm	50	Piece	-	L	213060	
83 mm	32 mm	30 mm	38 mm	6	Bag	12 Piece	L	204822 GP	
Material: raw steel, Surface: hot-dip galvanised									
83 mm	30 mm	32 mm	38 mm	100	Piece	-	L	213459	
Material: stainless steel									
83 mm	30 mm	32 mm	38 mm	50	Piece	-	L	213336 VA	
83 mm	30 mm	32 mm	38 mm	20	Card	4 Piece	L	213275 VA	

Fence bracket L shape

with wood screw
 Drive: hexagon head (star) size 30
 Wooden thread Ø: 8 x 45 mm

Assembly note: Holes with Ø 6 mm must be predrilled in the timber post before the fence bracket can be installed.

Accessory note: For easy fixation and adjustment use our drive-in tool for fence bracket no. 208790

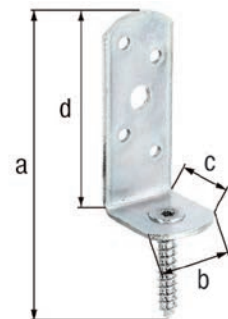

Dimension a	Dimension b	Dimension c	Dimension d	Material thickness	UNIT	PU	Contents per PU	Deliv-ery time	Order no. 4004338...
Material: raw steel, Surface: galvanised, thick-film passivated									
115 mm	31.5 mm	30 mm	75 mm	2.50 mm	50	Piece	-	L	213237
Material: stainless steel									
115 mm	31.5 mm	30 mm	75 mm	2.00 mm	24	Piece	-	L	326159 VA

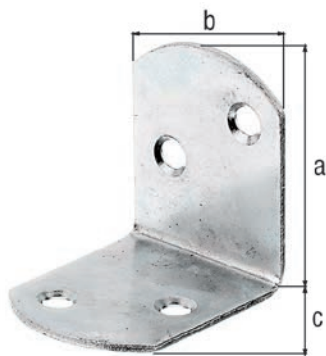

Fence angle bracket L shape

with countersunk screw holes

Type: equal sided

Material thickness: 2.00 mm

Assembly note: Holes with \varnothing 6 mm must be predrilled in the timber post before the fence bracket can be installed.

Accessory note: For easy fixation and adjustment use our drive-in tool for fence bracket no. 208790

Dimension a	Dimension b	Dimension c	UNIT	PU	Contents per PU	Deliv-ery time	Order no.
Material: raw steel, Surface: galvanised, thick-film passivated							
37 mm	37 mm	30 mm	100	Piece	-	L	204747

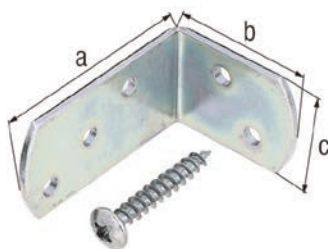

Fence angle bracket

Material thickness: 2.50 mm

Screw length: 27 mm

Screw \varnothing : 4 mm

Accessory note: Screws included.

Dimension a	Dimension b	Dimension c	UNIT	PU	Contents per PU	Deliv-ery time	Order no.
Material: raw steel, Surface: galvanised, thick-film passivated							
60 mm	40 mm	30 mm	10	Pack	24 Piece	L	208820

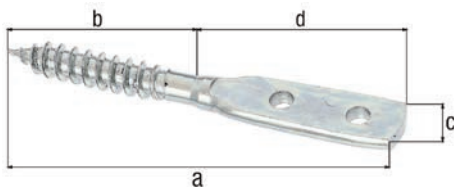

Fence bracket, flat-leaf screw shape

Distance from middle to middle of holes: 15 mm

Material thickness: 3.00 mm

Thread- \varnothing : 7 mm

Assembly note: Holes with \varnothing 6 mm must be predrilled in the timber post before the fence bracket can be installed.

Dimension a	Dimension b	Dimension c	Dimension d	UNIT	PU	Contents per PU	Deliv-ery time	Order no.
Material: raw steel, Surface: galvanised, thick-film passivated, for screwing in								
77 mm	35 mm	11.5 mm	34 mm	25	Piece	-	L	213473

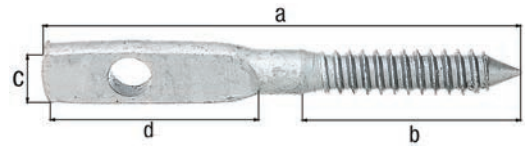

Fence bracket, flat-leaf screw shape

Material thickness: 3.00 mm
Thread-Ø: 10 mm

Assembly note: Holes with Ø 6 mm must be predrilled in the timber post before the fence bracket can be installed.

Dimension a	Dimension b	Dimension c	Dimension d	UNIT	PU	Contents per PU	Deliv-ery time	Order no. 4004338...
Material: raw steel, Surface: hot-dip galvanised, for screwing in								
100 mm	40 mm	14.5 mm	47 mm	50	Piece	-	L	213534

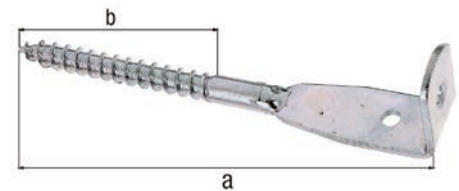

Fence bracket, flat-leaf screw shape

for assembly of timber or metal espaliers to indoor or outdoor walls
Type: angled
Thread-Ø: 10 mm

Assembly note: Holes with Ø 6 mm must be predrilled in the timber post before the fence bracket can be installed.

Dimension a	Dimension b	UNIT	PU	Contents per PU	Deliv-ery time	Order no. 4004338...
Material: raw steel, Surface: galvanised, thick-film passivated, for screwing in						
160 mm	75 mm	20	Piece	-	L	213251

Fence hinge

with unattached brass pin
with countersunk screw holes
Type: rolled
Material thickness: 2.50 mm

Dimension a	Dimension b	UNIT	PU	Contents per PU	Deliv-ery time	Order no. 4004338...
Material: raw steel, Surface: galvanised, thick-film passivated						
90 mm	90 mm	10	Piece	-	L	213299

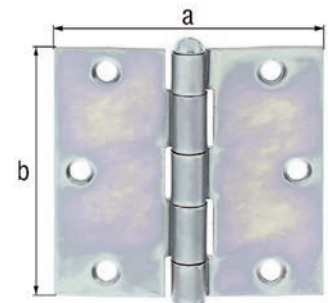

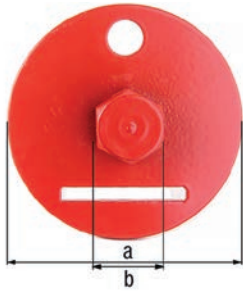

Screw-in tool for fence bracket

- Easy installation of the fence bracket to the post. Prevents surface damage.

Dimension a-Ø	Dimension b	UNIT	PU	Contents per PU	Deliv-ery time	Order no.
Material: raw steel, Surface: zinc phosphate plated, ruby red powder-coated RAL 3003						
60 mm	17 mm	10	Piece	-	L	208790

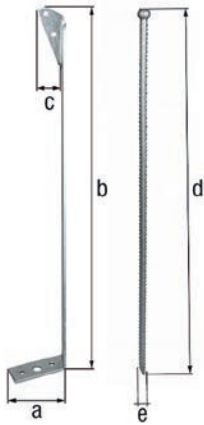

Ground anchor

ground spike made of ripple steel
ground anchor and ground spike connected by cable tie
Flat iron: 40 x 5 mm

Assembly note: Ground anchor can be fixed either by screws in a foundation or with a ground spike in earth.

Dimension a	Dimension b	Dimension c	Dimension d	Dimension e-Ø	UNIT	PU	Contents per PU	Deliv-ery time	Order no.
Material: raw steel, Surface: hot-dip galvanised									
109 mm	637 mm	50 mm	700 mm	12 mm	1	Piece	-	L	219338

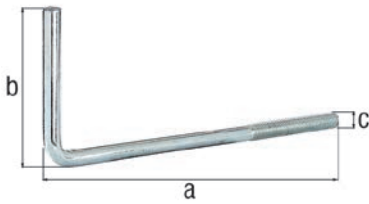

Fence rail connector

suitable for securing fence traverses to wooden and concrete posts
Thread: M12

Dimension a	Dimension b	Dimension c-Ø	UNIT	PU	Contents per PU	Deliv-ery time	Order no.
Material: raw steel, Surface: blue galvanised, for screwing through							
190 mm	110 mm	10.7 mm	30	Piece	-	L	218232

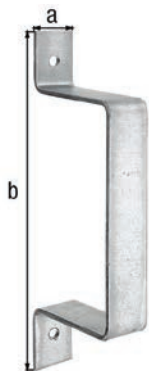

Slip rail bracket

fittings for paddock gates
Material thickness: 5.00 mm

Dimension a	Dimension b	UNIT	PU	Contents per PU	Deliv-ery time	Order no.
Material: raw steel, Surface: hot-dip galvanised						
40 mm	320 mm	1	Piece	-	L	202873

Palisade fencing bracket

for posts and half-round fence rails, Ø 100 mm

fittings for paddock fence middle assembly
Material thickness: 2.50 mm

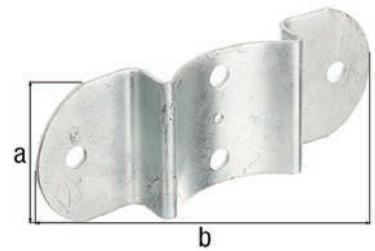

Dimension a	Dimension b	UNIT	PU	Contents per PU	Deliv-ery time	Order no. 4004338...
Material: raw steel, Surface: hot-dip galvanised						
70 mm	180 mm	10	Piece	-	L	202835

Palisade fencing bracket

for posts and half-round fence rails, Ø 100 mm

fittings for handrail assembly
Material thickness: 2.00 mm

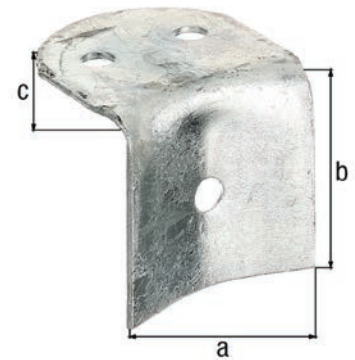

Dimension a	Dimension b	Dimension c	UNIT	PU	Contents per PU	Deliv-ery time	Order no. 4004338...
Material: raw steel, Surface: hot-dip galvanised							
70 mm	65 mm	70 mm	10	Piece	-	L	202880

Palisade fencing bracket

for posts and palisade posts, Ø 100 mm

fittings for paddock fence middle assembly
Material thickness: 2.50 mm

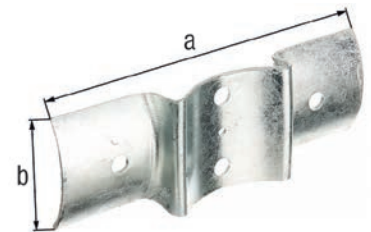

Dimension a	Dimension b	UNIT	PU	Contents per PU	Deliv-ery time	Order no. 4004338...
Material: raw steel, Surface: hot-dip galvanised						
200 mm	70 mm	10	Piece	-	L	202811

Palisade fencing bracket

for posts and palisade posts, Ø 100 mm

fittings for paddock fence corner and end assembly
Material thickness: 2.50 mm

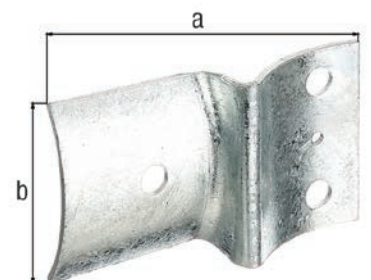

Dimension a	Dimension b	UNIT	PU	Contents per PU	Deliv-ery time	Order no. 4004338...
Material: raw steel, Surface: hot-dip galvanised						
117.5 mm	70 mm	10	Piece	-	L	202828

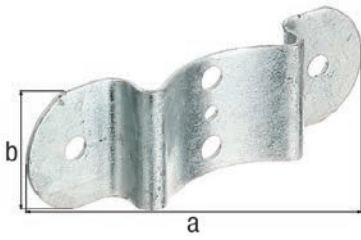

Palisade fencing bracket

for posts and half-round fence rails, Ø 80 mm
 fittings for lattice and picket fence middle assembly
 Material thickness: 2.00 mm

Dimension a	Dimension b	UNIT	PU	Contents per PU	Deliv-ery time	Order no. 4004338...
121 mm	40 mm	10	Piece	-	L	202859

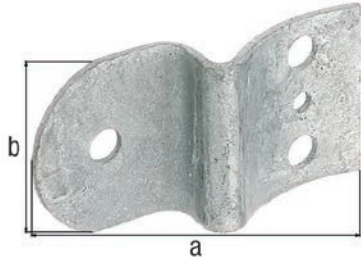

Palisade fencing bracket

for posts and half-round fence rails, Ø 80 mm
 fittings for lattice and picket fence corner and end assembly
 Material thickness: 2.00 mm

Dimension a	Dimension b	UNIT	PU	Contents per PU	Deliv-ery time	Order no. 4004338...
78 mm	40 mm	10	Piece	-	L	202866



Drive-in tool for round wooden posts

Insertion depth: 60 mm

- The drive-in tool prevents major damage to the palisade timber when driving into the ground.

Assembly note: can be used for palisade timber up to a diameter of 80 mm
 As plastic diffuses and the plasticisers in the material are gradually lost over time, the plastic will become rough and dry. We therefore recommend that you place the tool in water over night the day before it is used.

Dimension a-Ø	Dimension b	Insertion depth	Type	UNIT	PU	Contents per PU	Deliv-ery time	Order no. 4004338...
95 mm	90 mm	60 mm	pot closed	1	Piece	-	L	211219

Door lifter to hang or unhinge doors

with black rubberised tread
 fulcrum reinforced with felt
 Width: 30 mm
 Max. latch height: 70 mm
 Material thickness: 5.00 mm
 Material thickness of felt: 4.00 mm



UNIT	PU	Contents per PU	Delivery time	Order no. 4004338...
10	Piece	-	L	870119

Door stopper

Dimension a	UNIT	PU	Contents per PU	Deliv- ery time	Order no. 4004338...
180 mm	3	Card	1 Piece	L	417666



Door stopper

reversible with lever
 Distance from middle to middle of holes: 60 mm

Dimension a	Dimension b	Dimension c	Dimension d	UNIT	PU	Contents per PU	Deliv- ery time	Order no. 4004338...
230 mm	23 mm	20 mm	75 mm	5	Piece	-	L	417673
230 mm	23 mm	20 mm	75 mm	5	Piece	-	L	417642

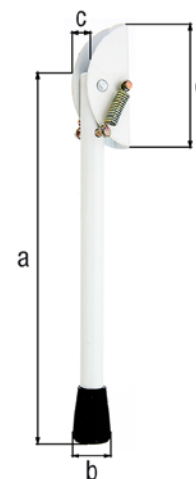

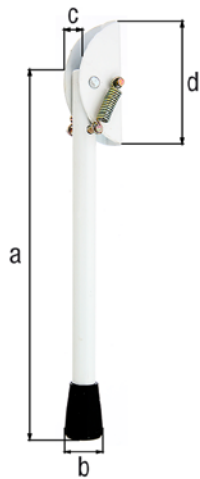

Door stopper, for attaching to doors

reversible with lever
Distance from middle to middle of holes: 60 mm

Dimension a	Dimension b	Dimension c	Dimension d	UNIT	PU	Contents per PU	Deliv-ery time	Order no. 4004338...
Material: raw steel, Surface: blue galvanised								
150 mm	29 mm	18 mm	63.5 mm	10	Piece	-	L	417628

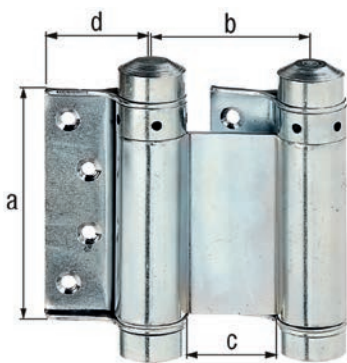

Swinging door hinge

with countersunk screw holes
with adjusting pin and adjusting rivet
For: 18 - 25 mm

Assembly note: Maximum leaf weight when used in pairs (2 pcs. per leaf) and maximum leaf width of 600 mm: 15 kg

Dimension a	Dimension b	Dimension c	Dimension d	UNIT	PU	Contents per PU	Deliv-ery time	Order no. 4004338...
Material: raw steel, Surface: blue galvanised								
76 mm	52 mm	29 mm	34 mm	5	Card	1 Piece	L	411664

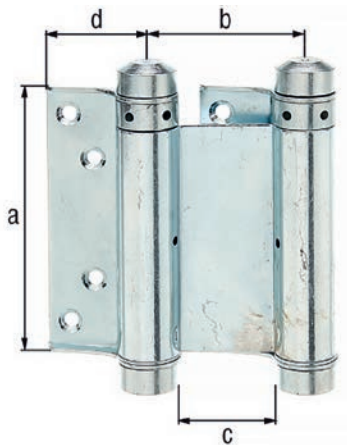

Swinging door hinge

with countersunk screw holes
with adjusting pin and adjusting rivet
For: 25 - 30 mm

Assembly note: Maximum leaf weight when used in pairs (2 pcs. per leaf) and maximum leaf width of 700 mm: 18 kg

Dimension a	Dimension b	Dimension c	Dimension d	UNIT	PU	Contents per PU	Deliv-ery time	Order no. 4004338...
Material: raw steel, Surface: blue galvanised								
100 mm	53 mm	31 mm	36 mm	5	Card	1 Piece	L	411671

Roller snap lock for swinging gates

with countersunk screw holes

with adjustable roller
with locking plate
Plate: 18 x 90 mm

UNIT	PU	Contents per PU	Delivery time	Order no. 4004338...
Material: raw steel, Surface: galvanised, thick-film passivated				
5	Card	1 Piece	L	411695



Gate fastener

Material thickness: 2.00 mm

Dimension a	Dimension b	UNIT	PU	Contents per PU	Deliv- ery time	Order no. 4004338...
Material: raw steel, Surface: blue galvanised						
122 mm	85 mm	10	Piece	-	L	210502
Material: raw steel, Surface: blue galvanised, black powder-coated						
122 mm	85 mm	10	Piece	-	L	209414

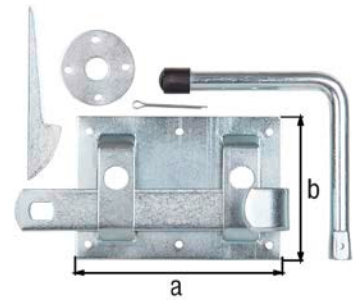

Gate storm spring chain

Max. gate weight: 40 kg

Dimension a	Dimension b	UNIT	PU	Contents per PU	Deliv- ery time	Order no. 4004338...
Material: raw steel, Surface: blue galvanised						
40.5 mm	40.5 mm	5	Piece	-	L	209391



Gate catcher with buffer and hook

Material thickness: 4.00 mm

Dimension a	Dimension b	Dimension c	UNIT	PU	Contents per PU	Deliv- ery time	Order no. 4004338...
Material: raw steel, Surface: galvanised							
290 mm	40 mm	220 mm	1	Bag	-	L	411794
Material: raw steel, Surface: galvanised, black powder-coated							
290 mm	40 mm	220 mm	1	Bag	-	L	411732

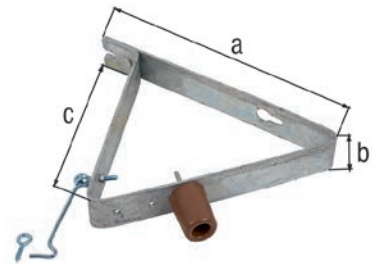



Swing hook for round timber

with carabiner for attaching the swing rope
 carabiner located in plastic ring
 carabiner connected to hook with S hook
 carabiner not available separately
 Max. load capacity: 70 kg

Assembly note: use screw to prevent the hook from turning

Dimension a-Ø	UNIT	PU	Contents per PU	Deliv-ery time	Order no. 4004338...
Material: raw steel, Surface: galvanised, thick-film passivated					
100 mm	6	Piece	-	L	207502
120 mm	6	Piece	-	L	207519

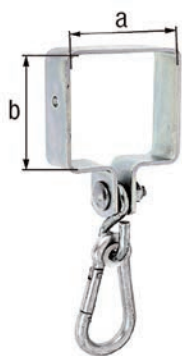

Swing hook for square timber

with carabiner for attaching the swing rope
 carabiner located in plastic ring
 carabiner connected to hook with S hook
 suitable for wooden swings made of squared timber
 carabiner not available separately
 Max. load capacity: 70 kg

Assembly note: use screw to prevent the hook from turning

Dimension a	Dimension b	UNIT	PU	Contents per PU	Deliv-ery time	Order no. 4004338...
Material: raw steel, Surface: galvanised, thick-film passivated						
90 mm	90 mm	6	Piece	-	L	217518



Swing hook

with carabiner for attaching the swing rope
 carabiner located in plastic ring
 carabiner not available separately
 Thread: M12
 Carabiner: 10 x 100 mm
 Max. load capacity: 70 kg

Accessory note: delivery includes accessories consisting of one nut, one safety nut and two washers

Dimension a	UNIT	PU	Contents per PU	Deliv-ery time	Order no. 4004338...
Material: raw steel, Surface: galvanised, thick-film passivated, for screwing through					
200 mm	10	Piece	-	L	204907

Swing hook with wood thread

Thread-Ø: 12 x 55 mm

Assembly note:

Swing hook with wood thread: must be screwed in a minimum of 10 mm beyond the thread (70 mm) into the wooden beam so that the bending moment, the main load, does not act on the thread. The wooden beam must be at least 80 mm thick: For a 12 mm swing hook, a 9 mm drill must be used to drill to a depth of 75 mm. For a 10 mm swing hook, it must be pre-drilled to a depth of 50 mm with a 7 mm drill. In the event of dry cracks in the wood in the area of the boreholes, the hooks must be removed as there is a risk that the hooks could break due to the notch effect.

Swing hook in masonry: If the wire is 10 mm thick, the S 12 dowel plug must be used to secure the swing hook in masonry; if the wire is 12 mm thick, the S 14 dowel plug must be used. The swing hook must be screwed into the dowel plug 15 mm beyond the thread. The dowel opening must be flush with the wall.

Important: For all methods of fastening, the eyelets of the swing hooks must be transverse to the direction of the swing. All locations that are in contact with metal parts must always be well lubricated. All of the load-bearing parts of a swing must be inspected regularly. Only use in pairs.

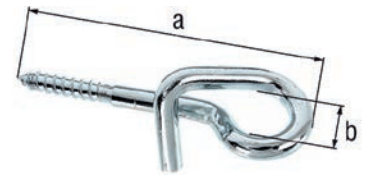

Dimension a	Dimension b-Ø	UNIT	PU	Contents per PU	Deliv-ery time	Order no. 4004338...
Material: raw steel, Surface: blue galvanised, for screwing in						
160 mm	11.5 mm	5	Piece	-	L	204525

Swing hook with thread

Thread: M12
Thread length: 80 mm

Assembly note:

For swing hooks with metric thread, the lower nut must be screwed tightly to the end of the thread. The thread thickness of the hook is 12 +/- 0.5 mm; the hole must be 12 + 0.5 mm. The upper nut must be locked. A constant check of the nuts must be carried out. The swing hook must not move in its support under any circumstances.

Important: For all methods of fastening, the eyelets of the swing hooks must be transverse to the direction of the swing. All locations that are in contact with metal parts must always be well lubricated. All of the load-bearing parts of a swing must be inspected regularly. Only use in pairs.

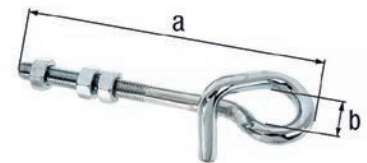

Dimension a	Dimension b-Ø	UNIT	PU	Contents per PU	Deliv-ery time	Order no. 4004338...
Material: raw steel, Surface: blue galvanised, for screwing through						
180 mm	10 mm	5	Piece	-	L	204532

Swing anchor for fixing in the ground

Screw length: 60 mm
Screw Ø: 8 mm

Assembly note:

The supporting post does not have to be embedded in the ground.

Set components:

One set consists of one clip, one ground nail and one lag bolt

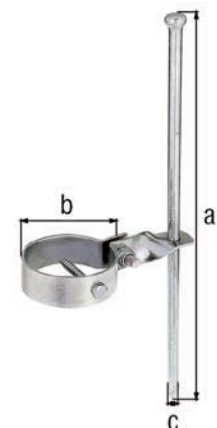

Dimension a	Dimension b-Ø	Dimension c-Ø	UNIT	PU	Contents per PU	Deliv-ery time	Order no. 4004338...
Material: raw steel, Surface: galvanised, thick-film passivated, individual parts attached with cable ties							
390 mm	80 mm	12 mm	6	Card	1 Piece	L	204853
390 mm	100 mm	12 mm	6	Card	1 Piece	L	204877



Ground anchor

Type: for screwing in
Volute Ø: 100 mm

Accessory note: Delivery includes fastening material consisting of one hexagonal screw DIN 571, Ø 10 x 70 mm and washer DIN 440, outer diameter Ø 34 mm, hot galvanized.

Dimension a	UNIT	PU	Contents per PU	Deliv-ery time	Order no. 4004338...
Material: raw steel, Surface: hot-dip galvanized					
525 mm	1	Piece	-	L	204938

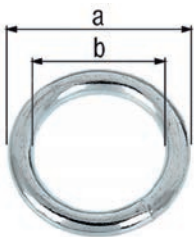

Mounting ring

Material thickness: 9.00 mm

Dimension a-Ø	Dimension b-Ø	UNIT	PU	Contents per PU	Deliv-ery time	Order no. 4004338...
Material: raw steel, Surface: blue galvanized						
65 mm	45 mm	10	Piece	-	L	204587

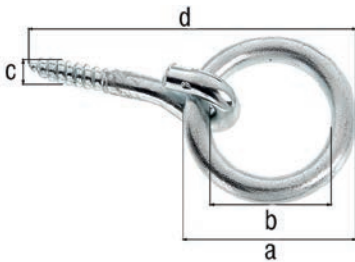

Mounting ring with screw

Thread length: 40 mm
Material thickness: 10.00 mm

Dimension a-Ø	Dimension b-Ø	Dimension c-Ø	Dimension d	UNIT	PU	Contents per PU	Deliv-ery time	Order no. 4004338...
Material: raw steel, Surface: blue galvanized, for screwing in								
65 mm	45 mm	10 mm	125 mm	10	Piece	-	L	204594



Mounting ring

Dimension a	Dimension b-Ø	Dimension c-Ø	Dimension d-Ø	Thread length	UNIT	PU	Contents per PU	Deliv-ery time	Order no. 4004338...
Material: raw steel, Surface: blue galvanized, for screwing in									
160 mm	36 mm	8 mm	22 mm	60 mm	25	Piece	-	L	204419
170 mm	47 mm	12 mm	25 mm	70 mm	10	Piece	-	L	204426

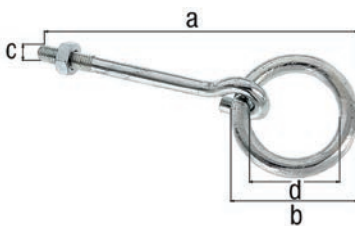

Mounting ring with thread

Thread: M10
Thread length: 30 mm
Material thickness: 10.00 mm

Dimension a	Dimension b-Ø	Dimension c-Ø	Dimension d-Ø	UNIT	PU	Contents per PU	Deliv-ery time	Order no. 4004338...
Material: raw steel, Surface: blue galvanized, for screwing through								
130 mm	65 mm	9 mm	45	10	Piece	-	L	204518

Mounting ring

Square bar: 5 x 5 mm

Material thickness: 10.00 mm

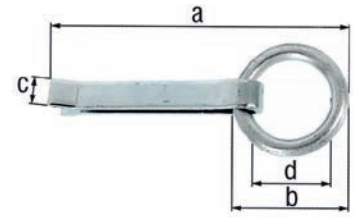

Dimension a	Dimension b-Ø	Dimension c	Dimension d-Ø	UNIT	PU	Contents per PU	Deliv-ery time	Order no. 4004338...
Material: raw steel, Surface: blue galvanised, for fixing in a wall								
170 mm	65 mm	15 mm	45 mm	10	Piece	-	L	204600

POST SUPPORTS

Made to last.

DECLARATION OF PERFORMANCE

GAH/LE-004 dated 14.07.2020

1. Product type: ETA 10/0210 post support
Type no.: 326, 327, 345, 365, 365v, 366, 367, 394, 451, 472, 480, 481, 665
2. Intended use: Post support for supporting timber pillars and posts as load-bearing elements
3. Manufacturer:
Gust. Alberts GmbH & Co. KG
Blumenthal 2
58849 Herscheid
Manufacturing plants 6166, 6167, 6168
4. Authorised representative: Not applicable
5. Assessment system: 2+
6. **+ 7 Technical specifications and notified bodies:**

	Name	No.	Assessment system	Reference document	EAD (ETAG) No. / EN standard
Technical assessment	ETA Danmark A/S	--	2+	ETA 10 / 0210 dated 02.07.2015	ETAG015:2013-04
In-house production control	Karlsruhe Institute of Technology	0769	2+	0769-CPR-6166-01 0769-CPR-6167-01 0769-CPR-6168-01	

8. Declared performance:

Essential characteristics	Performance	ETA section / EN standard
Characteristic load-bearing capacity	See annex	Annex B from ETA
Stiffness	No performance determined	
Ductility in cyclic testing	No performance determined	
Fire behaviour	Euroclass A1	DIN EN 13501-1: 2010-01
Hygiene, health and environmental protection	The product does not contain hazardous substances given in TR 034 of March 2012	ETA item 3
Sustainable utilisation of natural resources	No performance determined	
Durability	Steel S235JR, hot galvanized >55 µm Service class 1, 2 and 3 Stainless steel 1.4301 Service class 3	EN 1461:2009-10 EN 10088-3:2014-12 ETA II - item 3.11
Identification	See annex	See annex A from ETA 10/0210

9. The performance of the product in number 1 corresponds to the declared performance in number 8. The responsibility for the issuing of this declaration of performance in compliance with (EU) No. 305/2011 lies solely with the manufacturer stated in number 3. Signed for and in the name of the manufacturer by:

Lukas Sonntag

Name

Head of Quality Management

Role









Herscheid, 14 July 2020

Location and date of issue

i.A.

Signature

TABLE OF GUIDELINES

	CE	CE	CE	CE	CE	CE													CE
 max. 2,50 m Height max. 1,20 m		●	●	●	●	●	●	●	●	●	●	●	●	●	●	●	●	●	●
 max. 2,50 m Height max. 1,50 m	●	●	●	●		●		●	●	●	●	●	●	●	●	●	●	●	●
 max. 1,80 m Height max. 1,20 m	●	●	●		●			●	●	●	●	●	●	●	●			●	●
 max. 1,80 m Height max. 1,50 m	●	●	●					●	●	●	●	●	●	●	●			●	●
 max. 1,80 m Height max. 1,80 m	●																		
 max. 2,50 m Height max. 1,80 m	●	●	●																
 max. 2,00 m Height max. 1,80 m	●	●	●																
 max. 2,50 m Height max. 2,60 m	●																		
 max. 2,50 m Height max. 2,60 m	●																		

H post support

Material thickness: 5.00 mm

Assembly note: Statically suitable for high wooden and privacy fences. Suitable for timber construction and wooden fences as per the standard value table.

Accessory note: Suitable fasteners can be found in the range "Screws and accessories".

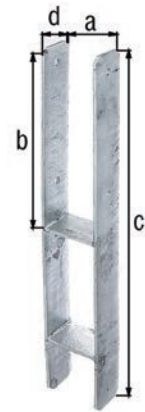

Dimension a	Dimension b	Dimension c	Dimension d	UNIT	PU	Contents per PU	Delivery time	Order no. 4004338...	
Material: raw steel, Surface: hot-dip galvanised, for setting in concrete, with CE marking in accordance with ETA-10/0210									
71 mm	300 mm	600 mm	60 mm	1	Piece	-	L	213800	CE
81 mm	300 mm	600 mm	60 mm	1	Piece	-	L	213817	CE
91 mm	300 mm	600 mm	60 mm	1	Piece	-	L	213824	CE
101 mm	300 mm	600 mm	60 mm	1	Piece	-	L	203917	CE
111 mm	300 mm	600 mm	60 mm	1	Piece	-	L	203924	CE
116 mm	300 mm	600 mm	60 mm	1	Piece	-	L	203931	CE
121 mm	300 mm	600 mm	60 mm	1	Piece	-	L	203948	CE

H post support

Material thickness: 6.00 mm

Assembly note: Statically suitable for carports, high wooden and privacy fences. Suitable for timber construction and wooden fences as per the standard value table.

Accessory note: Suitable fasteners can be found in the range "Screws and accessories".

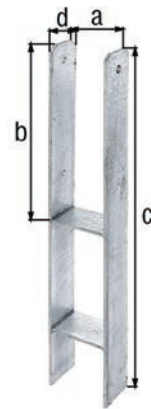

Dimension a	Dimension b	Dimension c	Dimension d	UNIT	PU	Contents per PU	Delivery time	Order no. 4004338...	
Material: raw steel, Surface: hot-dip galvanised, for setting in concrete, with CE marking in accordance with ETA-10/0210									
91 mm	300 mm	600 mm	60 mm	1	Piece	-	L	213626	CE
95 mm	300 mm	600 mm	60 mm	1	Piece	-	L	213886	CE
101 mm	300 mm	600 mm	60 mm	1	Piece	-	L	213831	CE
111 mm	300 mm	600 mm	60 mm	1	Piece	-	L	213879	CE
116 mm	300 mm	600 mm	60 mm	1	Piece	-	L	213916	CE
121 mm	300 mm	600 mm	60 mm	1	Piece	-	L	213848	CE
141 mm	300 mm	600 mm	60 mm	1	Piece	-	L	213893	CE
91 mm	300 mm	800 mm	60 mm	1	Piece	-	L	219925	CE
111 mm	300 mm	800 mm	60 mm	1	Piece	-	L	219949	CE
116 mm	300 mm	800 mm	60 mm	1	Piece	-	L	208417	CE
121 mm	300 mm	800 mm	60 mm	1	Piece	-	L	208424	CE
141 mm	300 mm	800 mm	60 mm	1	Piece	-	L	208431	CE

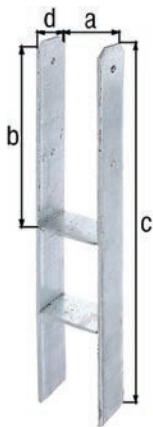

H post support

Material thickness: 8.00 mm

Assembly note: Statically suitable for carports, gate posts, high wooden and privacy fences. Suitable for timber construction and wooden fences as per the standard value table.

Accessory note: Suitable fasteners can be found in the range "Screws and accessories".

	Dimension a	Dimension b	Dimension c	Dimension d	UNIT	PU	Contents per PU	Deliv-ery time	Order no. 4004338...
Material: raw steel, Surface: hot-dip galvanised, for setting in concrete, with CE marking in accordance with ETA-10/0210									
CE	116 mm	400 mm	800 mm	80 mm	1	Piece	-	L	208448
CE	121 mm	400 mm	800 mm	80 mm	1	Piece	-	L	205003
CE	141 mm	400 mm	800 mm	80 mm	1	Piece	-	L	205010
CE	161 mm	400 mm	800 mm	80 mm	1	Piece	-	L	208455

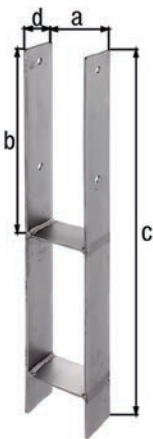

H post support

Material thickness: 4.00 mm

Accessory note: Suitable fasteners can be found in the range "Screws and accessories".

	Dimension a	Dimension b	Dimension c	Dimension d	UNIT	PU	Contents per PU	Deliv-ery time	Order no. 4004338...
Material: stainless steel, for setting in concrete									
VA	91 mm	300 mm	600 mm	60 mm	1	Piece	-	L	213718



U post support with concrete anchor made of riffle steel

Concrete anchor Ø: 16 mm
Material thickness: 4.00 mm

Assembly note: Not statically suitable for high wooden and privacy fences. Suitable for timber construction and wooden fences as per the standard value table.

Accessory note: Suitable fasteners can be found in the range "Screws and accessories".

	Dimension a	Dimension b	Dimension c	Dimension d	UNIT	PU	Contents per PU	Deliv-ery time	Order no. 4004338...
Material: raw steel, Surface: hot-dip galvanised, for setting in concrete, with CE marking in accordance with ETA-10/0210									
15 CE	71 mm	104 mm	200 mm	60 mm	1	Piece	-	L	214234
CE	75 mm	104 mm	200 mm	60 mm	1	Piece	-	L	214241
CE	81 mm	104 mm	200 mm	60 mm	1	Piece	-	L	214258
15 CE	91 mm	104 mm	200 mm	60 mm	1	Piece	-	L	214265
15 CE	101 mm	104 mm	200 mm	60 mm	1	Piece	-	L	214289
CE	121 mm	104 mm	200 mm	60 mm	1	Piece	-	L	214296
CE	141 mm	104 mm	200 mm	60 mm	1	Piece	-	L	214302

U post support with concrete anchor made of riffle steel

with post supports on the side for constructive wood protection
 Concrete anchor Ø: 16 mm
 Material thickness: 4.00 mm

Assembly note: Not statically suitable for high wooden and privacy fences.

Accessory note: Suitable fasteners can be found in the range "Screws and accessories".

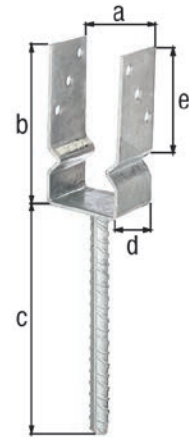

Dimension a	Dimension b	Dimension c	Dimension d	Dimension e	UNIT	PU	Contents per PU	Deliv-ery time	Order no. 4004338...
Material: raw steel, Surface: hot-dip galvanised, for setting in concrete									
71 mm	150 mm	200 mm	60 mm	100 mm	1	Piece	-	L	208509
91 mm	150 mm	200 mm	60 mm	100 mm	1	Piece	-	L	208523

U post support with extra long concrete anchor made of riffle steel

Concrete anchor Ø: 16 mm
 Material thickness: 4.00 mm

Assembly note: Not statically suitable for high wooden and privacy fences. Suitable for timber construction and wooden fences as per the standard value table.

Accessory note: Suitable fasteners can be found in the range "Screws and accessories".

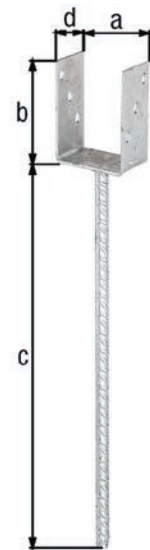

Dimension a	Dimension b	Dimension c	Dimension d	UNIT	PU	Contents per PU	Deliv-ery time	Order no. 4004338...
Material: raw steel, Surface: hot-dip galvanised, for setting in concrete								
91 mm	100 mm	400 mm	60 mm	1	Piece	-	L	214401
101 mm	100 mm	400 mm	60 mm	1	Piece	-	L	214418
121 mm	100 mm	400 mm	60 mm	1	Piece	-	L	212711





U post support with concrete anchor made of round steel

Concrete anchor Ø: 16 mm
 Material thickness: 4.00 mm

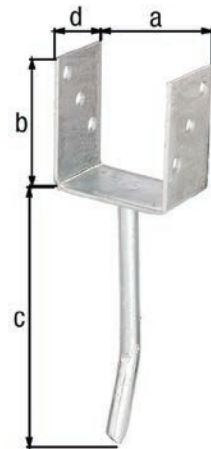
Assembly note: Not statically suitable for high wooden and privacy fences.

Accessory note: Suitable fasteners can be found in the range "Screws and accessories".



Dimension a	Dimension b	Dimension c	Dimension d	UNIT	PU	Contents per PU	Deliv-ery time	Order no. 4004338...
Material: raw steel, Surface: hot-dip galvanised, for setting in concrete, with CE marking in accordance with ETA-10/0210								
71 mm	104 mm	200 mm	60 mm	1	Piece	-	L	214043 
81 mm	104 mm	200 mm	60 mm	1	Piece	-	L	214067 
91 mm	104 mm	200 mm	60 mm	1	Piece	-	L	214074 
101 mm	104 mm	200 mm	60 mm	1	Piece	-	L	214098 
121 mm	104 mm	200 mm	60 mm	1	Piece	-	L	214104 



U post support with concrete anchor made of round steel

Concrete anchor Ø: 16 mm
Material thickness: 4.00 mm

Assembly note: Not statically suitable for high wooden and privacy fences.

Accessory note: Suitable fasteners can be found in the range "Screws and accessories".

	Dimension a	Dimension b	Dimension c	Dimension d	UNIT	PU	Contents per PU	Deliv-ery time	Order no. 4004338...
Material: stainless steel, for setting in concrete									
VA	71 mm	104 mm	200 mm	60 mm	1	Piece	-	L	214203
VA	91 mm	104 mm	200 mm	60 mm	1	Piece	-	L	214210

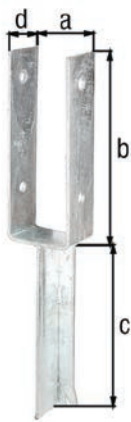

U post support with concrete anchor made of T-iron

Concrete anchor: 40 x 4 mm
Material thickness: 4.00 mm

Assembly note: Statically suitable for fence heights up to a maximum of 1500 mm with normal post distance. Suitable for timber construction and wooden fences as per the standard value table.
The post support leg must be mounted perpendicular to the course of the fence in order to be able to absorb the strong lateral wind forces.

Accessory note: Suitable fasteners can be found in the range "Screws and accessories".

	Dimension a	Dimension b	Dimension c	Dimension d	UNIT	PU	Contents per PU	Deliv-ery time	Order no. 4004338...
Material: raw steel, Surface: hot-dip galvanised, for setting in concrete, with CE marking in accordance with ETA-10/0210									
CE	71 mm	200 mm	200 mm	50 mm	1	Piece	-	L	216740
CE	91 mm	200 mm	200 mm	50 mm	1	Piece	-	L	216771
CE	101 mm	200 mm	200 mm	50 mm	1	Piece	-	L	216795

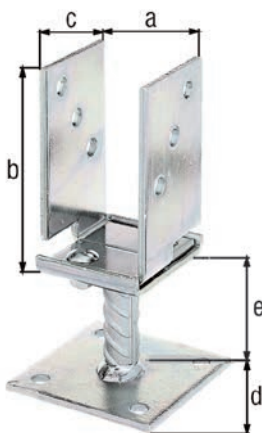

U post support

type: width adjustable

for wooden posts thicknesses from 71 to 131 mm
Rippled steel Ø: 19 mm
Distance from ground: 90 mm
Material thickness: 5.00 mm

Assembly note: Not statically suitable for high wooden and privacy fences.

Accessory note: Suitable fasteners can be found in the range "Screws and accessories".

	Dimension a	Dimension b	Dimension c	Dimension d	Dimension e	UNIT	PU	Contents per PU	Deliv-ery time	Order no. 4004338...
Material: raw steel, Surface: galvanised, thick-film passivated, for screwing on										
	71 - 131 mm	110 mm	70 mm	70 mm	100 mm	1	Piece	-	L	214500

U post support with concrete anchor made of rifle steel

type: width adjustable

for wooden posts thicknesses from 71 to 131 mm
 Concrete anchor Ø: 16 mm
 Material thickness: 5.00 mm

Assembly note: Not statically suitable for high wooden and privacy fences. Suitable for timber construction and wooden fences as per the standard value table.

Accessory note: Suitable fasteners can be found in the range "Screws and accessories".

Dimension a	Dimension b	Dimension c	Dimension d	UNIT	PU	Contents per PU	Deliv-ery time	Order no. 4004338...
Material: raw steel, Surface: galvanised, thick-film passivated, for setting in concrete								
71 - 131 mm	110 mm	200 mm	70 mm	1	Piece	-	L	214494

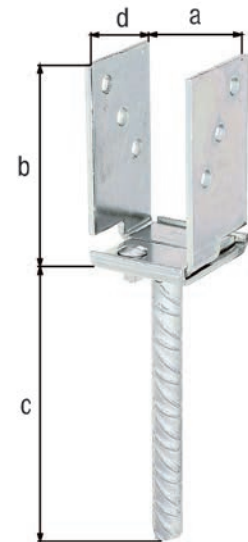

U post support with concrete anchor made of rifle steel

type: width adjustable

for wooden posts thicknesses from 75 bis 180 mm
 Concrete anchor Ø: 20 mm
 Material thickness: 4.00 mm

Assembly note: Not statically suitable for high wooden and privacy fences. Suitable for timber construction and wooden fences as per the standard value table.

Accessory note: Suitable fasteners can be found in the range "Screws and accessories".

Dimension a	Dimension b	Dimension c	Dimension d	UNIT	PU	Contents per PU	Deliv-ery time	Order no. 4004338...
Material: raw steel, Surface: blue galvanised, for setting in concrete								
75 - 180 mm	108 mm	200 mm	61 mm	1	Piece	-	L	214890

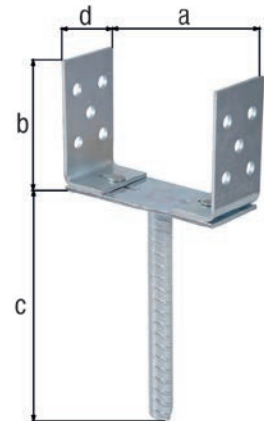

U post support

type: height and width adjustable

for wooden posts thicknesses from 71 to 161 mm
 Plate thickness: 5 mm
 Material thickness: 5.00 mm

- The M20 thread allows the height of the ground clearance to be adjusted from 150 to 190 mm while mounted.

Assembly note: Suitable for timber construction and wooden fences as per the standard value table.

Accessory note: Suitable fasteners can be found in the range "Screws and accessories".

Dimension a	Dimension b	Dimension c	Dimension d	Dimension e	UNIT	PU	Contents per PU	Deliv-ery time	Order no. 4004338...
Material: raw steel, Surface: galvanised, thick-film passivated, for screwing on									
71 - 161 mm	120 mm	150 - 190 mm	70 mm	100 mm	1	Piece	-	L	218058

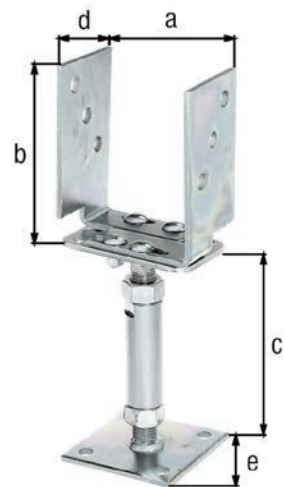

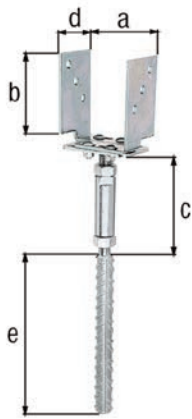

U post support with concrete anchor made of rifle steel

type: height and width adjustable

for wooden posts thicknesses from 71 to 161 mm
 Concrete anchor Ø: 24 mm
 Material thickness: 5.00 mm

- Ground clearance to be adjusted by 60 mm while mounted.

Assembly note: Suitable for timber construction and wooden fences as per the standard value table.

Accessory note: Suitable fasteners can be found in the range "Screws and accessories".

Dimension a	Dimension b	Dimension c	Dimension d	Dimension e	UNIT	PU	Contents per PU	Deliv-ery time	Order no. 4004338...
71 - 161 mm	110 mm	125 - 185 mm	70 mm	250 mm	1	Piece	-	L	219901

Material: raw steel, Surface: galvanised, thick-film passivated, for setting in concrete

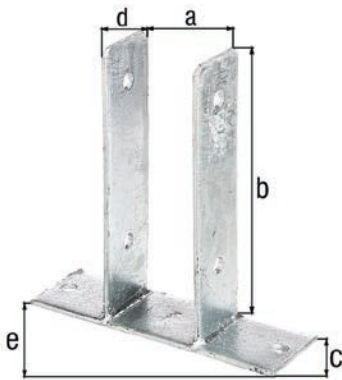

U post support

Material thickness: 4.00 mm

Assembly note: Statically suitable for lattice, plank, and lath fences up to 1800 mm for light pergolas. Suitable for timber construction and wooden fences as per the standard value table.

Accessory note: Suitable fasteners can be found in the range "Screws and accessories".

	Dimension a	Dimension b	Dimension c	Dimension d	Dimension e	UNIT	PU	Contents per PU	Deliv-ery time	Order no. 4004338...
CE	71 mm	200 mm	60 mm	50 mm	200 mm	1	Piece	-	L	212766
CE	81 mm	200 mm	60 mm	50 mm	200 mm	1	Piece	-	L	212780
CE	91 mm	200 mm	60 mm	50 mm	200 mm	1	Piece	-	L	212797
CE	101 mm	200 mm	60 mm	50 mm	200 mm	1	Piece	-	L	212810
CE	121 mm	200 mm	60 mm	50 mm	200 mm	1	Piece	-	L	212827

Material: raw steel, Surface: hot-dip galvanised, for screwing on, with CE marking in accordance with ETA-10/0210

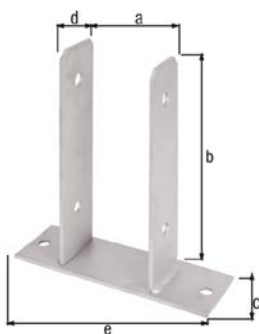

U post support

Material thickness: 4.00 mm

Assembly note: Statically suitable for lattice, plank, and lath fences up to 1800 mm for light pergolas. Suitable for timber construction and wooden fences as per the standard value table.

Accessory note: Suitable fasteners can be found in the range "Screws and accessories".

	Dimension a	Dimension b	Dimension c	Dimension d	Dimension e	UNIT	PU	Contents per PU	Deliv-ery time	Order no. 4004338...
VA	71 mm	200 mm	60 mm	50 mm	200 mm	1	Piece	-	L	212902
VA	91 mm	200 mm	60 mm	50 mm	200 mm	1	Piece	-	L	212919

Material: stainless steel, for screwing on

U post support

with post supports on the side for constructive wood protection
Material thickness: 4.00 mm

Assembly note: Not statically suitable for high wooden and privacy fences. Suitable for timber construction and wooden fences as per the standard value table.

Accessory note: Suitable fasteners can be found in the range "Screws and accessories".

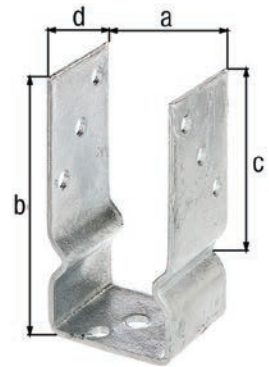

Dimension a	Dimension b	Dimension c	Dimension d	UNIT	PU	Contents per PU	Deliv-ery time	Order no. 4004338...
Material: raw steel, Surface: hot-dip galvanised, for screwing on, with CE marking in accordance with ETA-10/0210								
71 mm	150 mm	100 mm	60 mm	1	Piece	-	L	217600 15 CE
81 mm	150 mm	100 mm	60 mm	1	Piece	-	L	217617 CE
91 mm	150 mm	100 mm	60 mm	1	Piece	-	L	217624 15 CE
101 mm	150 mm	100 mm	60 mm	1	Piece	-	L	217631 CE
121 mm	150 mm	100 mm	60 mm	1	Piece	-	L	217648 CE

U post support for L border blocks

for square timber posts 90 mm

Square tube: 60 x 40 x 2 mm
Flat iron: 60 x 6 mm
Material thickness: 2.00 mm

Assembly note: Suitable for timber construction and wooden fences as per the standard value table.

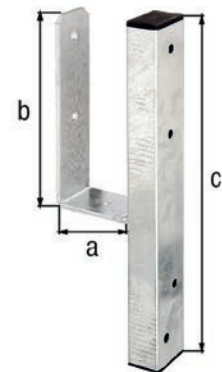

Dimension a	Dimension b	Dimension c	UNIT	PU	Contents per PU	Deliv-ery time	Order no. 4004338...
Material: raw steel, Surface: hot-dip galvanised, for screwing on, with CE marking in accordance with ETA-10/0210							
91 mm	230 mm	410 mm	1	Piece	-	L	214432 CE

L post support with concrete anchor made of riffle steel

Concrete anchor Ø: 16 mm
Material thickness: 4.00 mm

Assembly note: Not statically suitable for high wooden and privacy fences.

Accessory note: Suitable fasteners can be found in the range "Screws and accessories".

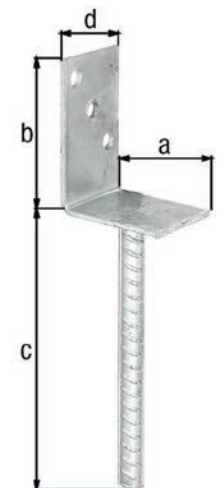

Dimension a	Dimension b	Dimension c	Dimension d	UNIT	PU	Contents per PU	Deliv-ery time	Order no. 4004338...
Material: raw steel, Surface: hot-dip galvanised, for setting in concrete, with CE marking in accordance with ETA-10/0210								
80 mm	104 mm	200 mm	60 mm	1	Piece	-	L	213954 15 CE

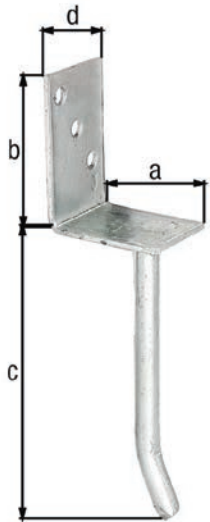

L post support with concrete anchor made of round steel

Concrete anchor Ø: 16 mm
Material thickness: 4.00 mm

Assembly note: Not statically suitable for high wooden and privacy fences. Suitable for timber construction and wooden fences as per the standard value table.

Accessory note: Suitable fasteners can be found in the range "Screws and accessories".

	Dimension a	Dimension b	Dimension c	Dimension d	UNIT	PU	Contents per PU	Deliv-ery time	Order no. 4004338...
Material: raw steel, Surface: hot-dip galvanised, for setting in concrete, with CE marking in accordance with ETA-10/0210									
CE	80 mm	104 mm	200 mm	60 mm	1	Piece	-	L	214005

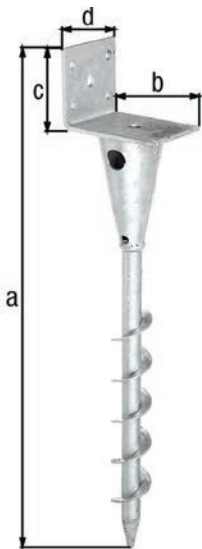

L post support for square timber posts

suitable for timbers up to 90 x 90 mm
suitable for terraces with wooden tiles
Material thickness: 4.00 mm

Assembly note: Suitable for fixing horizontal square fence posts on the ground. For the installation we recommend drive-in tool no. 208394.

Accessory note: Suitable fasteners can be found in the range "Screws and accessories".

	Dimension a	Dimension b	Dimension c	Dimension d	UNIT	PU	Contents per PU	Deliv-ery time	Order no. 4004338...
Material: raw steel, Surface: hot-dip galvanised, for screwing in									
	470 mm	95 mm	70 mm	70 mm	1	Piece	-	L	212278

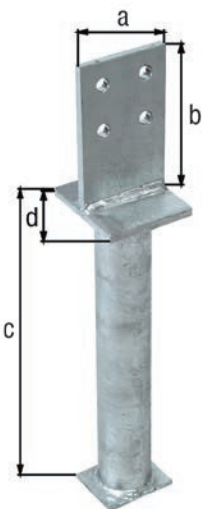

T post support with flitch plate

Tube Ø: 48.3 mm
Material thickness: 8.00 mm

	Dimension a	Dimension b	Dimension c	Dimension d	UNIT	PU	Contents per PU	Deliv-ery time	Order no. 4004338...
Material: raw steel, Surface: hot-dip galvanised, for setting in concrete									
	80 mm	130 mm	500 mm	90 mm	1	Piece	-	L	212681

T post support with flitch plate

Plate thickness: 6 mm
 Concrete anchor Ø: 16 mm
 Material thickness of flitch plate: 6.00 mm

Assembly note: Not statically suitable for high wooden and privacy fences.

Dimension a	Dimension b	Dimension c	Dimension d	UNIT	PU	Contents per PU	Delivery time	Order no. 4004338...
Material: raw steel, Surface: hot-dip galvanised, for setting in concrete								
80 mm	130 mm	200 mm	80 mm	1	Piece	-	L	215521

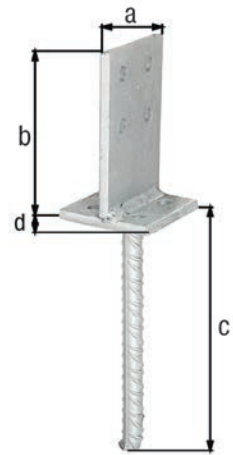

T post support with flitch plate

Plate thickness: 5 mm
 Material thickness of flitch plate: 8.00 mm

Assembly note: Not statically suitable for high wooden and privacy fences.

Dimension a	Dimension b	Dimension c	UNIT	PU	Contents per PU	Delivery time	Order no. 4004338...
Material: raw steel, Surface: hot-dip galvanised, for screwing on							
80 mm	130 mm	100 mm	1	Piece	-	L	215538

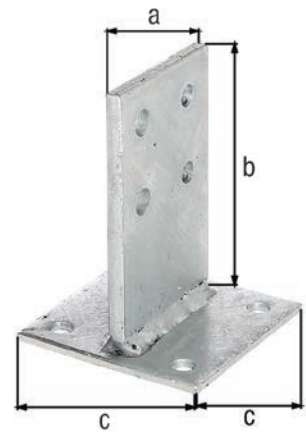

I post support with pin

Plate thickness: 5 mm
 Concrete anchor Ø: 16 mm

Assembly note: Not statically suitable for high wooden and privacy fences.

Accessory note: Suitable fasteners can be found in the range "Screws and accessories".

Dimension a	Dimension b	Dimension c	Dimension d	Dimension e-Ø	UNIT	PU	Contents per PU	Delivery time	Order no. 4004338...
Material: raw steel, Surface: hot-dip galvanised, for setting in concrete									
100 mm	200 mm	70 mm	70 mm	16 mm	1	Piece	-	L	215446

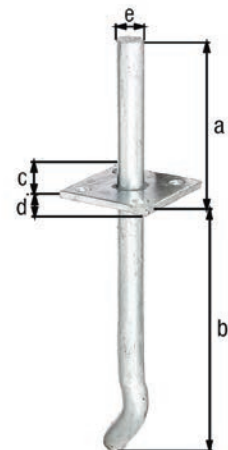

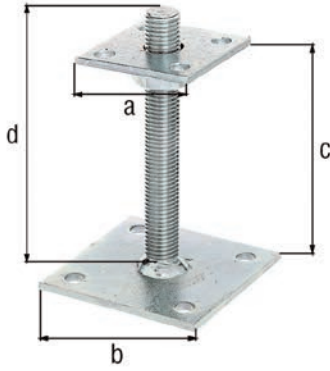

I post support

type: height adjustable

Material thickness: 5.00 mm
Thread: M20

Assembly note: Not statically suitable for high wooden and privacy fences.

Accessory note: Suitable fasteners can be found in the range "Screws and accessories".

Dimension a	Dimension b	Dimension c	Dimension d	UNIT	PU	Contents per PU	Deliv-ery time	Order no. 4004338...
Material: raw steel, Surface: galvanised, thick-film passivated, for screwing on								
70 mm	100 mm	30 - 150 mm	150 mm	1	Piece	-	L	218102
150 mm	100 mm	30 - 150 mm	150 mm	1	Piece	-	L	218119

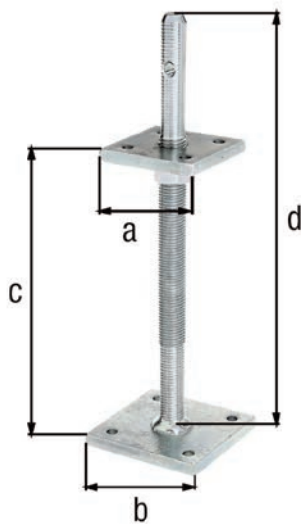

I post support

type: height adjustable

Thread: M22

Assembly note: Not statically suitable for high wooden and privacy fences.

Accessory note: Suitable fasteners can be found in the range "Screws and accessories".

Dimension a	Dimension b	Dimension c	Dimension d	UNIT	PU	Contents per PU	Deliv-ery time	Order no. 4004338...
Material: raw steel, Surface: galvanised, thick-film passivated, for screwing on								
80 mm	100 mm	100 - 230 mm	340 mm	1	Piece	-	L	217532

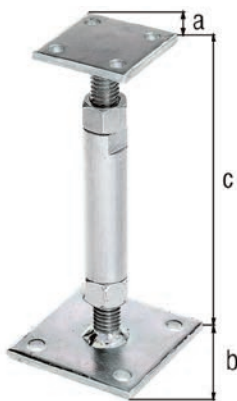

Post support

type: height adjustable

Material thickness of upper plate: 6.00 mm
Material thickness of lower plate: 5.00 mm

• The M20 thread allows the height of the ground clearance to be adjusted from 150 to 190 mm while mounted.

Accessory note: Suitable fasteners can be found in the range "Screws and accessories".

Dimension a	Dimension b	Dimension c	UNIT	PU	Contents per PU	Deliv-ery time	Order no. 4004338...
Material: raw steel, Surface: galvanised, thick-film passivated, for screwing on							
70 mm	100 mm	150 - 190 mm	1	Piece	-	L	212391

Post support

Accessory note: Suitable fasteners can be found in the range "Screws and accessories".

Dimension a	Dimension b	Dimension c	Dimension d	Dimension e	Tube Ø	Plate thickness	UNIT	PU	Contents per PU	Delivery time	Order no. 4004338...
Material: raw steel, Surface: hot-dip galvanised, for screwing on											
90 mm	70 mm	70 mm	90 mm	78 mm	27 mm	4 mm	1	Piece	-	L	219826
100 mm	100 mm	100 mm	100 mm	100 mm	42 mm	5 mm	1	Piece	-	L	219802

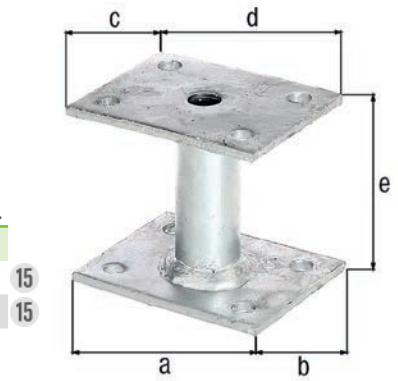

Post support

Tube Ø: 42 mm
Plate thickness: 5 mm

Dimension a	Dimension b	Dimension c	UNIT	PU	Contents per PU	Delivery time	Order no. 4004338...
Material: raw steel, Surface: hot-dip galvanised, for screwing on							
150 mm	100 mm	100 mm	1	Piece	-	L	219819
150 mm	100 mm	150 mm	1	Piece	-	L	210823

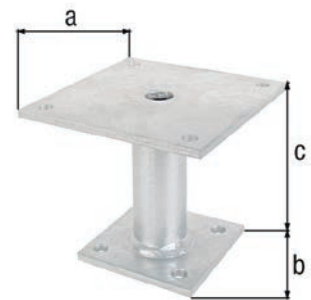

Post support for blind wood attachment

with concrete anchor from round tube

- No fittings are visible when the post (at least 90 x 90 mm) is mounted.
- The stable screw on the post support keeps the post seated properly.

Assembly note: Statically suitable for lattice, lath and plank fences up to 1500 mm high. Only to be used for wooden fences when wall connections or angle constructions form a structural unit. Holes of a Ø 15 mm must be predrilled in the timber post before the fence bracket can be installed.

Dimension a	Dimension b	Dimension c-Ø	Dimension d-Ø	UNIT	PU	Contents per PU	Delivery time	Order no. 4004338...
Material: raw steel, Surface: hot-dip galvanised, for setting in concrete, with CE marking in accordance with ETA-10/0210								
400 mm	140 mm	42 mm	70 mm	1	Piece	-	L	208028

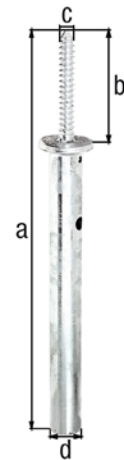

Post support for blind wood attachment

- The stable screw on the post support keeps the post seated properly.

Assembly note: Suitable for timber construction and wooden fences as per the standard value table. Holes of a Ø 15 mm must be predrilled in the timber post before the fence bracket can be installed.

Dimension a	Dimension b	Dimension c	Dimension d	Dimension e-Ø	UNIT	PU	Contents per PU	Delivery time	Order no. 4004338...
Material: raw steel, Surface: hot-dip galvanised, for screwing on, with CE marking in accordance with ETA-10/0210									
45 mm	140 mm	100 mm	120 mm	70 mm	1	Piece	-	L	208035

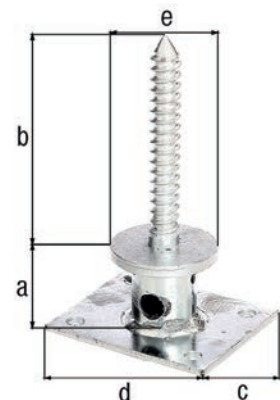



Post support with movable upper part for angular walls

Assembly note: Suitable for fence construction (here use of at least 2 posts connected with fence rails), bracing posts or similar applications. Post support can not be fixed in the joint.

Accessory note: Suitable fasteners can be found in the range "Screws and accessories".

Dimension a	Dimension b	Dimension c	UNIT	PU	Contents per PU	Deliv-ery time	Order no. 4004338...
Material: raw steel, Surface: hot-dip galvanised, for screwing on							
71 mm	60 mm	100 mm	1	Piece	-	L	208707
91 mm	60 mm	100 mm	1	Piece	-	L	208714

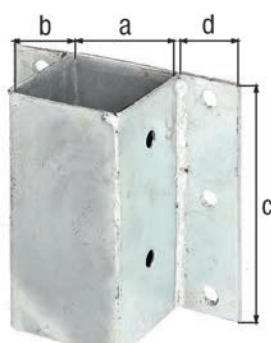

Post support for L and U border blocks or walls

Assembly note: Suitable for timber construction and wooden fences as per the standard value table.

Accessory note: Suitable fasteners can be found in the range "Screws and accessories".

Dimension a	Dimension b	Dimension c	Dimension d	UNIT	PU	Contents per PU	Deliv-ery time	Order no. 4004338...
Material: raw steel, Surface: hot-dip galvanised, for screwing on								
71 mm	71 mm	150 mm	40 mm	1	Piece	-	L	208721
91 mm	91 mm	150 mm	40 mm	1	Piece	-	L	208738

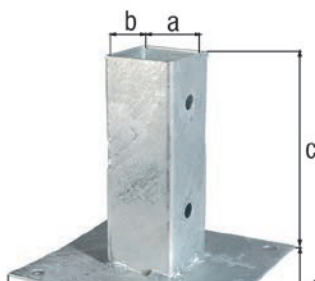

Bolt down post support for square timber posts

Assembly note: Suitable for timber construction and wooden fences as per the standard value table.

Accessory note: Suitable fasteners can be found in the range "Screws and accessories".

Dimension a	Dimension b	Dimension c	Dimension d	Dimension e	UNIT	PU	Contents per PU	Deliv-ery time	Order no. 4004338...
Material: raw steel, Surface: hot-dip galvanised									
61 mm	61 mm	150 mm	150 mm	150 mm	1	Piece	-	L	211608
71 mm	71 mm	150 mm	150 mm	150 mm	1	Piece	-	L	211615
91 mm	91 mm	150 mm	150 mm	150 mm	1	Piece	-	L	211639
101 mm	101 mm	150 mm	150 mm	150 mm	1	Piece	-	L	216245
121 mm	121 mm	150 mm	180 mm	180 mm	1	Piece	-	L	217679

Bolt down post support for square timber posts

for flush fixing to corners

Assembly note: Suitable for timber construction and wooden fences as per the standard value table.

Accessory note: Suitable fasteners can be found in the range "Screws and accessories".

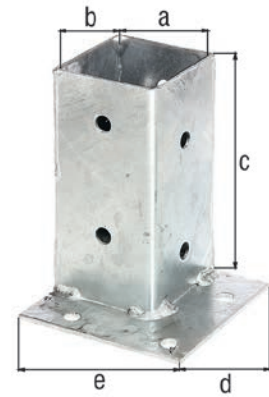

Dimension a	Dimension b	Dimension c	Dimension d	Dimension e	UNIT	PU	Contents per PU	Deliv-ery time	Order no. 4004338...
Material: raw steel, Surface: hot-dip galvanised, for screwing on									
71 mm	71 mm	150 mm	114 mm	114 mm	1	Piece	-	L	211714
91 mm	91 mm	150 mm	134 mm	134 mm	1	Piece	-	L	211721

Bolt down post support for square timber posts

for flush fixing to straight surfaces

Assembly note: Suitable for timber construction and wooden fences as per the standard value table.

Accessory note: Suitable fasteners can be found in the range "Screws and accessories".

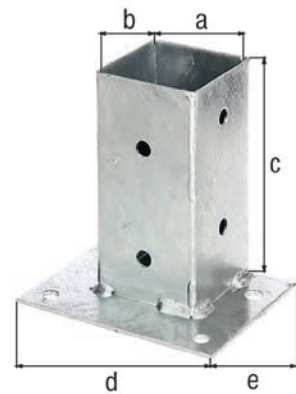

Dimension a	Dimension b	Dimension c	Dimension d	Dimension e	UNIT	PU	Contents per PU	Deliv-ery time	Order no. 4004338...
Material: raw steel, Surface: hot-dip galvanised, for screwing on									
71 mm	71 mm	150 mm	143 mm	114 mm	1	Piece	-	L	211738
91 mm	91 mm	150 mm	163 mm	134 mm	1	Piece	-	L	211745

Ground sleeve for square timber posts

Accessory note: Suitable fasteners can be found in the range "Screws and accessories".

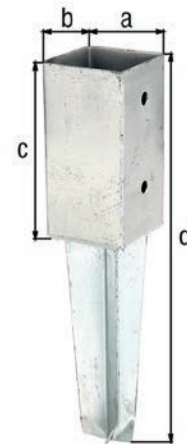

Dimension a	Dimension b	Dimension c	Dimension d	UNIT	PU	Contents per PU	Deliv-ery time	Order no. 4004338...
Material: raw steel, Surface: hot-dip galvanised, for setting in concrete								
71 mm	71 mm	150 mm	350 mm	1	Piece	-	L	211851
91 mm	91 mm	150 mm	350 mm	1	Piece	-	L	211868

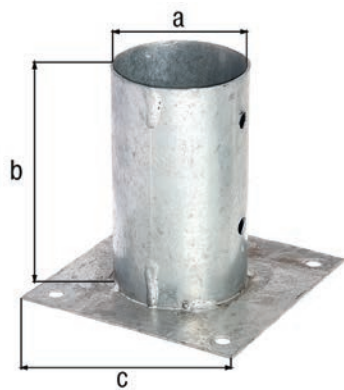

Bolt down post support for round timber posts

Assembly note: Suitable for timber construction and wooden fences as per the standard value table.

Accessory note: Suitable fasteners can be found in the range "Screws and accessories".

Dimension a-Ø	Dimension b	Dimension c	UNIT	PU	Contents per PU	Deliv-ery time	Order no. 4004338...
Material: raw steel, Surface: hot-dip galvanised, for screwing on							
81 mm	150 mm	150 mm	1	Piece	-	L	211653
101 mm	150 mm	150 mm	1	Piece	-	L	211707
121 mm	147 mm	180 mm	1	Piece	-	L	211806
141 mm	147 mm	200 mm	1	Piece	-	L	211776



Assembly aid for post supports, ground sleeves, metal posts

- Use mason's lacing cord to ensure that the fence course is straight
- We recommend a spirit level with angle to align the posts
- Carpenter's pencil

Set components: One set consists of one angle spirit level, adjustable by 270°, three levels, four magnets, one adjustable rubber band for detent, one 20 m roll of mason's lacing cord Ø 1.0 mm thick, and one carpenter's pencil

UNIT	PU	Contents per PU	Delivery time	Order no. 4004338...
Material: plastic, colour: grey, packed in polybag with plastic slider				
5	Bag	1 Set	L	212087

Fence post spike for square timber posts

Assembly note: Suitable for timber construction and wooden fences as per the standard value table.

Accessory note: Suitable fasteners can be found in the range "Screws and accessories".

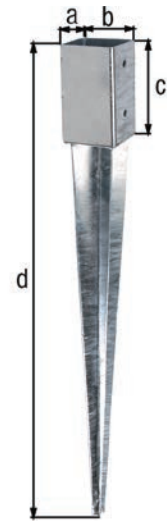

Dimension a	Dimension b	Dimension c	Dimension d	UNIT	PU	Contents per PU	Deliv-ery time	Order no. 4004338...
Material: raw steel, Surface: hot-dip galvanised, for driving in								
46 mm	46 mm	100 mm	550 mm	1	Piece	-	L	208172
61 mm	61 mm	150 mm	750 mm	1	Piece	-	L	208288
71 mm	71 mm	150 mm	750 mm	1	Piece	-	L	211271
71 mm	71 mm	150 mm	900 mm	1	Piece	-	L	211295
91 mm	91 mm	150 mm	750 mm	1	Piece	-	L	211288
91 mm	91 mm	150 mm	900 mm	1	Piece	-	L	211301
101 mm	101 mm	150 mm	900 mm	1	Piece	-	L	211318

Fence post spike for square timber posts

with adjustable support for later adjustment of the timber post

Assembly note: Suitable for timber construction and wooden fences as per the standard value table.

Accessory note: Suitable fasteners can be found in the range "Screws and accessories".

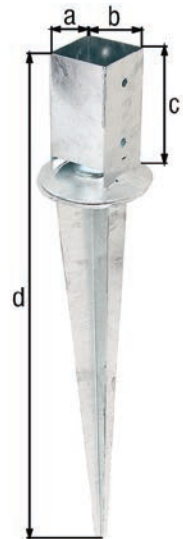

Dimension a	Dimension b	Dimension c	Dimension d	UNIT	PU	Contents per PU	Deliv-ery time	Order no. 4004338...
Material: raw steel, Surface: hot-dip galvanised								
71 mm	71 mm	150 mm	750 mm	1	Piece	-	L	208103
71 mm	71 mm	150 mm	900 mm	1	Piece	-	L	208127
91 mm	91 mm	150 mm	750 mm	1	Piece	-	L	208110
91 mm	91 mm	150 mm	900 mm	1	Piece	-	L	208134

Fence post spike for round timber posts

Assembly note: Suitable for timber construction and wooden fences as per the standard value table.

Accessory note: Suitable fasteners can be found in the range "Screws and accessories".

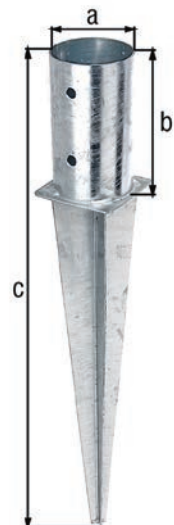

Dimension a-Ø	Dimension b	Dimension c	UNIT	PU	Contents per PU	Deliv-ery time	Order no. 4004338...
Material: raw steel, Surface: hot-dip galvanised, for driving in							
81 mm	150 mm	600 mm	1	Piece	-	L	211387
101 mm	150 mm	600 mm	1	Piece	-	L	211394
121 mm	145 mm	750 mm	1	Piece	-	L	211462
141 mm	145 mm	750 mm	1	Piece	-	L	211455

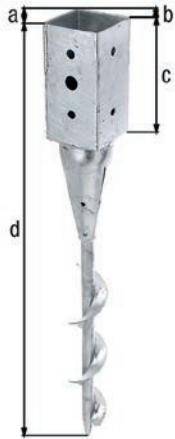

Ground screw for square timber posts

Assembly note: Suitable for timber construction and wooden fences as per the standard value table.
For the installation we recommend drive-in tool no. 208394.

Accessory note: Suitable fasteners can be found in the range "Screws and accessories".

Dimension a	Dimension b	Dimension c	Dimension d	UNIT	PU	Contents per PU	Deliv-ery time	Order no. 4004338...
Material: raw steel, Surface: hot-dip galvanised, for screwing in								
71 mm	71 mm	150 mm	595 mm	1	Piece	-	L	208370
91 mm	91 mm	150 mm	595 mm	1	Piece	-	L	208387

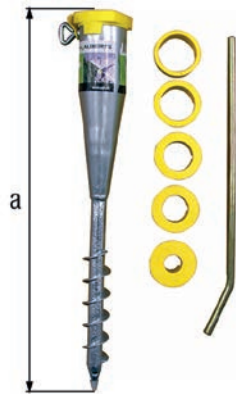

Ground screw for tubes

suitable for all supporting tubes from Ø25 to 65 mm

Accessory note: Drive-in tool, 440mm included.

	Dimension a	UNIT	PU	Contents per PU	Deliv-ery time	Order no. 4004338...
Material: raw steel, Surface: hot-dip galvanised						
15	560 mm	8	Piece	-	L	610630
15	560 mm	100	Piece	-	L	610647



Drive-in tool

for drive-in ground sleeves 70 x 70 mm and 80 mm Ø

Assembly note: As plastic diffuses and the plasticisers in the material are gradually lost over time, the plastic will become rough and dry. We therefore recommend that you place the tool in water over night the day before it is used.

	Dimension a	UNIT	PU	Contents per PU	Deliv-ery time	Order no. 4004338...
Material: plastic, impact resistant						
	195 mm	1	Piece	-	L	211233

Drive-in tool

for drive-in ground sleeves 90 x 90 mm, 100 x 100 mm and 100 mm Ø

Assembly note: As plastic diffuses and the plasticisers in the material are gradually lost over time, the plastic will become rough and dry. We therefore recommend that you place the tool in water over night the day before it is used.



Dimension a	UNIT	PU	Contents per PU	Deliv-ery time	Order no. 4004338...
Material: plastic, impact resistant					
170 mm	1	Piece	-	L	211240

Screw-in tool for all ground screws

Dimension a	Dimension b-Ø	UNIT	PU	Contents per PU	Deliv-ery time	Order no. 4004338...
Material: raw steel, Surface: galvanised, thick-film passivated						
950 mm	15 mm	1	Piece	-	L	208394



Assembly aid for post supports, ground sleeves, metal posts

- Use mason's lacing cord to ensure that the fence course is straight
- We recommend a spirit level with angle to align the posts
- Carpenter's pencil

Set components: One set consists of one angle spirit level, adjustable by 270°, three levels, four magnets, one adjustable rubber band for detent, one 20 m roll of mason's lacing cord Ø 1.0 mm thick, and one carpenter's pencil



UNIT	PU	Contents per PU	Delivery time	Order no. 4004338...
Material: plastic, colour: grey, packed in polybag with plastic slider				
5	Bag	1 Set	L	212087

CAPS FOR WOODEN POSTS

Made to last.

Post cap for wooden post, square

with countersunk screw holes
flat shaped

- Protects wood from weather effects.
- Can also be used for bevelled posts.

Assembly note: Secure attachment due to side screw connections.

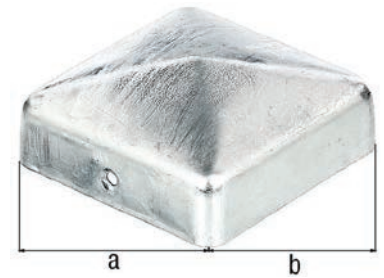

Dimension a	Dimension b	UNIT	PU	Contents per PU	Deliv-ery time	Order no. 4004338...
Material: raw steel, Surface: hot-dip galvanised						
70 mm	70 mm	10	Piece	-	L	205805
90 mm	90 mm	10	Piece	-	L	205843
100 mm	100 mm	10	Piece	-	L	216689
120 mm	120 mm	10	Piece	-	L	205881
Material: copper, Surface: zaponised (corrosion protection with clear varnish)						
70 mm	70 mm	10	Piece	-	L	217280
90 mm	90 mm	10	Piece	-	L	217297
Material: raw steel, Surface: blue galvanised, anthracite powder-coated						
70 mm	70 mm	10	Piece	-	L	205669
Material: raw steel, Surface: blue galvanised, black powder-coated						
70 mm	70 mm	10	Piece	-	L	205676
Material: stainless steel						
70 mm	70 mm	10	Piece	-	L	327064 VA
90 mm	90 mm	10	Piece	-	L	327071 VA

Post cap for wooden post, round

with countersunk screw holes
flat shaped

- Protects wood from weather effects.
- Can also be used for bevelled posts.

Assembly note: Secure attachment due to side screw connections.



Dimension a-Ø	UNIT	PU	Contents per PU	Deliv-ery time	Order no. 4004338...
Material: raw steel, Surface: hot-dip galvanised					
80 mm	10	Piece	-	L	205928
100 mm	10	Piece	-	L	205966



Post cap for wooden post

with ball top
with countersunk screw holes

- Protects wood from weather effects.
- Can also be used for bevelled posts.

Assembly note: Secure attachment due to side screw connections.

	Dimension a	Dimension b	Dimension c-Ø	UNIT	PU	Contents per PU	Deliv-ery time	Order no. 4004338...
Material: raw steel, Surface: hot-dip galvanised								
	70 mm	70 mm	60 mm	6	Piece	-	L	205829
	90 mm	90 mm	80 mm	6	Piece	-	L	205867
Material: copper, Surface: zaponised (corrosion protection with clear varnish)								
	70 mm	70 mm	60 mm	6	Piece	-	L	217303
	90 mm	90 mm	80 mm	6	Piece	-	L	217310
Material: stainless steel								
VA	70 mm	70 mm	60 mm	6	Piece	-	L	327088
VA	90 mm	90 mm	80 mm	6	Piece	-	L	327095

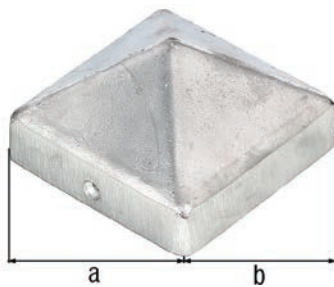

Post cap for wooden post

high shape
with countersunk screw holes

- Protects wood from weather effects.
- Can also be used for bevelled posts.

Assembly note: Secure attachment due to side screw connections.

	Dimension a	Dimension b	UNIT	PU	Contents per PU	Deliv-ery time	Order no. 4004338...
Material: cast aluminium, Surface: raw							
	70 mm	70 mm	10	Piece	-	L	217228
	90 mm	90 mm	10	Piece	-	L	217235
	111 mm	111 mm	10	Piece	-	L	217396
	120 mm	120 mm	10	Piece	-	L	217242
Material: cast aluminium, Surface: anthracite-metallic powder-coated							
	70 mm	70 mm	5	Piece	-	L	217082
	90 mm	90 mm	5	Piece	-	L	217099
Material: cast aluminium, Surface: white powder-coated RAL 9010							
	111 mm	111 mm	6	Piece	-	S	217402

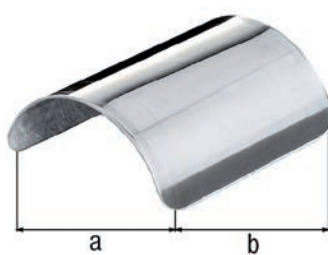

Post cap for rounded wooden posts

- Protects wood from weather effects.

Assembly note: With welded on nail

	Dimension a	Dimension b	UNIT	PU	Contents per PU	Deliv-ery time	Order no. 4004338...
Material: stainless steel							
VA	93 mm	110 mm	6	Piece	-	L	205638

WINDOW SHUTTER FITTINGS

Made to last.

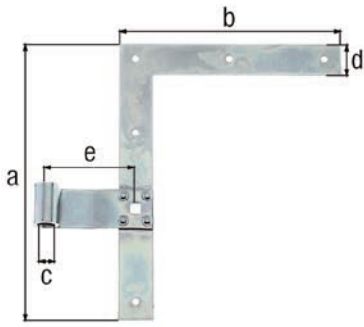

Fig. Top version

Window shutter corner hinge, straight, straight end

Width of the roller: 35 mm
 Roller thickness: 4 mm
 Material thickness: 3.00 mm

Accessory note: Suitable fasteners can be found in the range "Screws and accessories".

Item description	Dimension a	Dimension b	Dimension c-Ø	Dimension d	Dimension e	UNIT	PU	Contents per PU	Deliv-ery time	Order no. 4004338...
Material: raw steel, Surface: galvanised, thick-film passivated										
Top	250 mm	200 mm	13 mm	30 mm	75 mm	5	Piece	-	L	313326
Bottom	250 mm	200 mm	13 mm	30 mm	75 mm	5	Piece	-	L	313319

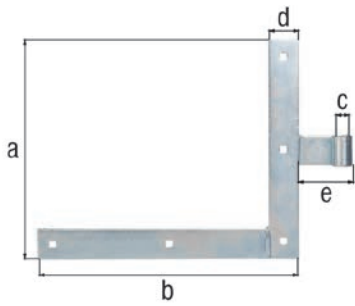

Window shutter corner hinge, straight, straight end

Width of the roller: 35 mm
 Roller thickness: 4 mm
 Material thickness: 4.00 mm

Item description	Dimension a	Dimension b	Dimension c-Ø	Dimension d	Dimension e	UNIT	PU	Contents per PU	Deliv-ery time	Order no. 4004338...
Material: raw steel, Surface: blue galvanised										
Top	250 mm	300 mm	14 mm	35 mm	68 mm	5	Piece	-	L	306403
Bottom	250 mm	300 mm	14 mm	35 mm	68 mm	5	Piece	-	L	308308
Material: raw steel, Surface: black cataphoretic coating										
Top	250 mm	300 mm	14 mm	35 mm	68 mm	5	Piece	-	L	306342
Bottom	250 mm	300 mm	14 mm	35 mm	68 mm	5	Piece	-	L	306373

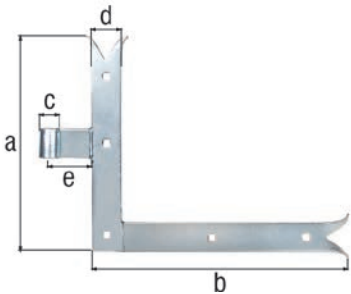

Window shutter corner hinge, straight, with decorative final

Width of the roller: 35 mm
 Roller thickness: 4 mm
 Material thickness: 4.00 mm

Item description	Dimension a	Dimension b	Dimension c-Ø	Dimension d	Dimension e	UNIT	PU	Contents per PU	Deliv-ery time	Order no. 4004338...
Material: raw steel, Surface: blue galvanised										
Top	250 mm	300 mm	14 mm	35 mm	68 mm	5	Piece	-	L	308483
Bottom	250 mm	300 mm	14 mm	35 mm	68 mm	5	Piece	-	L	308490
Material: raw steel, Surface: black cataphoretic coating										
Top	250 mm	300 mm	14 mm	35 mm	68 mm	5	Piece	-	L	306427
Bottom	250 mm	300 mm	14 mm	35 mm	68 mm	5	Piece	-	L	306458

Window shutter middle hinge, straight, straight end

Width of the roller: 35 mm
 Roller thickness: 4 mm
 Material thickness: 3.00 mm

Accessory note: Suitable fasteners can be found in the range "Screws and accessories".

Dimension a	Dimension b	Dimension c-Ø	Dimension d	UNIT	PU	Contents per PU	Deliv-ery time	Order no. 4004338...
Material: raw steel, Surface: galvanised, thick-film passivated								
200 mm	30 mm	13 mm	75 mm	5	Piece	-	L	313548
Material: stainless steel								
200 mm	30 mm	13 mm	75 mm	6	Piece	-	L	326135 VA

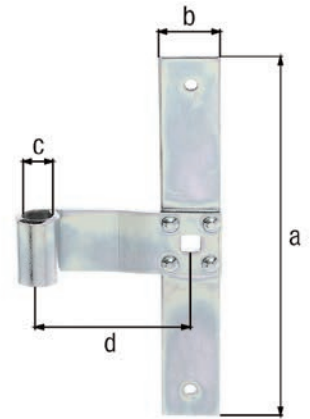

Window shutter middle hinge, straight, straight end

Width of the roller: 35 mm
 Roller thickness: 4 mm
 Material thickness: 4.00 mm

Dimension a	Dimension b	Dimension c-Ø	Dimension d	UNIT	PU	Contents per PU	Deliv-ery time	Order no. 4004338...
Material: raw steel, Surface: blue galvanised								
250 mm	35 mm	14 mm	68 mm	5	Piece	-	L	306526
Material: raw steel, Surface: black cataphoretic coating								
250 mm	35 mm	14 mm	68 mm	5	Piece	-	L	306502

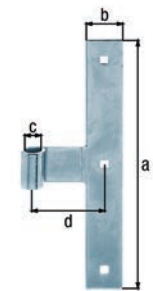

Window shutter middle hinge, straight, with decorative final

Width of the roller: 35 mm
 Roller thickness: 4 mm
 Material thickness: 4.00 mm

Dimension a	Dimension b	Dimension c-Ø	Dimension d	UNIT	PU	Contents per PU	Deliv-ery time	Order no. 4004338...
Material: raw steel, Surface: blue galvanised								
250 mm	35 mm	14 mm	68 mm	5	Piece	-	L	306557
Material: raw steel, Surface: black cataphoretic coating								
250 mm	35 mm	14 mm	68 mm	5	Piece	-	L	306519

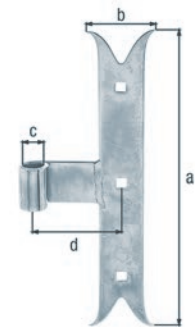

Window shutter middle hinge, centred

Width of the roller: 35 mm
 Roller thickness: 4 mm
 Material thickness: 4.00 mm

Dimension a	Dimension b	Dimension c-Ø	Dimension d	UNIT	PU	Contents per PU	Deliv-ery time	Order no. 4004338...
Material: raw steel, Surface: blue galvanised								
250 mm	35 mm	16 mm	50 mm	6	Piece	-	L	340544
Material: raw steel, Surface: blue galvanised, black powder-coated								
250 mm	35 mm	16 mm	50 mm	6	Piece	-	L	340551

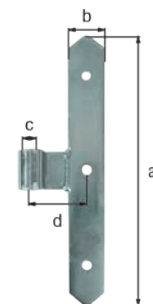

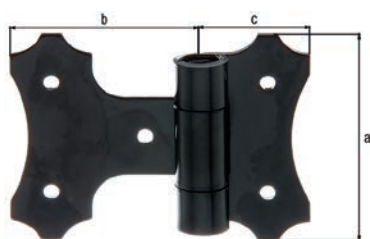

Window shutter hinge

Material thickness: 4.00 mm

Dimension a	Dimension b	Dimension c	UNIT	PU	Contents per PU	Deliv-ery time	Order no. 4004338...
Material: raw steel, Surface: zinc phosphate plated, black powder-coated							
94 mm	82 mm	48 mm	5	Piece	-	L	307035

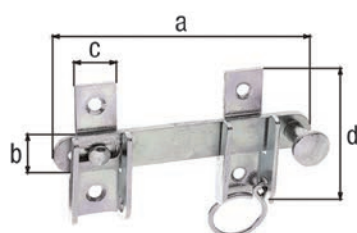

Shutter hasp with locking device

with countersunk screw holes
with ring for easy closing of window shutter

Dimension a	Dimension b	Dimension c	Dimension d	UNIT	PU	Contents per PU	Deliv-ery time	Order no. 4004338...
Material: raw steel, Surface: blue galvanised								
120 mm	18 mm	18 mm	65 mm	20	Piece	-	L	314330
Material: raw steel, Surface: galvanised, thick-film passivated								
120 mm	18 mm	18 mm	65 mm	20	Piece	-	L	314446
Material: raw steel, Surface: black cataphoretic coating								
120 mm	18 mm	18 mm	65 mm	10	Piece	-	L	307653



Security latch for window shutter

with countersunk screw holes

Set components: One set consists of eight screws Ø5 x 30 mm

Dimension a	UNIT	PU	Contents per PU	Deliv-ery time	Order no. 4004338...
Material: raw steel, Surface: galvanised black					
260 mm	3	Card	1 Piece	L	309312



Security bar for window shutters, made of flat steel

Material thickness: 4.00 mm

Dimension a	Dimension b	UNIT	PU	Contents per PU	Deliv-ery time	Order no. 4004338...
Material: raw steel, Surface: black cataphoretic coating						
1500 mm	25 mm	1	Piece	-	L	308155
2500 mm	25 mm	1	Piece	-	L	308162

Security bar for window shutters, made of round steel



Dimension a	Dimension b-Ø	UNIT	PU	Contents per PU	Deliv-ery time	Order no. 4004338...
Material: raw steel, Surface: black cataphoretic coating						
1570 mm	15 mm	1	Piece	-	L	308186
2400 mm	15 mm	1	Piece	-	L	308193

Security bar for window shutters, made of square steel



Dimension a	UNIT	PU	Contents per PU	Deliv-ery time	Order no. 4004338...
Material: raw steel, Surface: black cataphoretic coating					
410 mm	5	Piece	-	L	309220
980 mm	5	Piece	-	L	309237

Accessory kit for security bar for window shutters made of flat steel with countersunk screw holes

UNIT	PU	Contents per PU	Delivery time	Order no. 4004338...
Material: raw steel, Surface: galvanised black				
5	Blister	1 Piece	L	308179



Accessory kit for security bar for window shutters made of round steel

Set components: One set consists of one latch with latch plate, one latch hook, three staples, two angled end caps and one truss-head bolt with nut

UNIT	PU	Contents per PU	Delivery time	Order no. 4004338...
Material: raw steel, Surface: black powder-coated				
5	Blister	1 Piece	L	308209

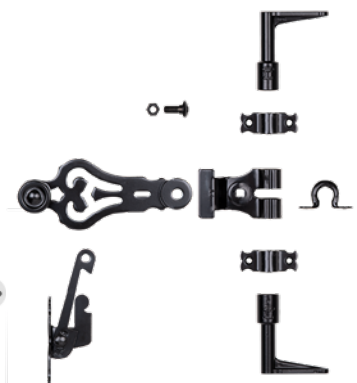

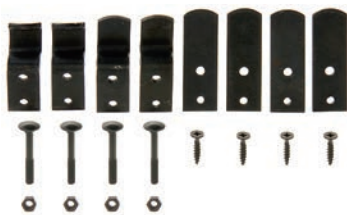

Accessory kit for security bar for window shutters made of square steel

Set components: One set consists of four holders and mounting hardware

UNIT	PU	Contents per PU	Delivery time	Order no. 4004338...
Material: raw steel, Surface: galvanised black				
5	Blister	1 Piece	L	309282

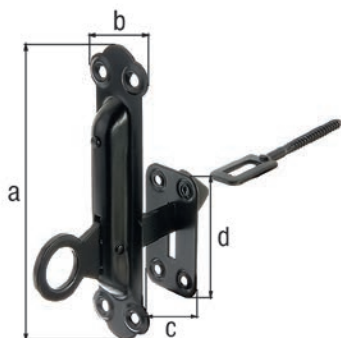

Window shutter lock, fastening with plate

with countersunk screw holes

suitable for window shutters with width up to 35 mm
Thread-Ø: 6 x 21 mm

Dimension a	Dimension b	Dimension c	Dimension d	UNIT	PU	Contents per PU	Deliv-ery time	Order no. 4004338...
Material: raw steel, Surface: zinc phosphate plated, black powder-coated								
150 mm	38 mm	37 mm	37 mm	10	Piece	-	L	307097



Window shutter lock

Set components: One set consists of two friction irons, two friction plates, two fastening plates, two threaded rods and fastening material

Dimension a	UNIT	PU	Contents per PU	Deliv-ery time	Order no. 4004338...
Material: raw steel, Surface: galvanised black					
180 mm	5	Pack	2 Piece	L	309367

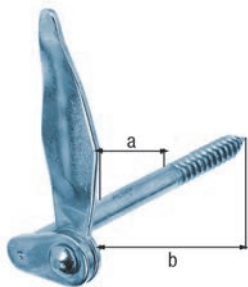

Window shutter stopper, type Marseillais

without stop

with wood thread

Accessory note: suitable stop see article no. 307189, 308438

Wooden thread Ø	Dimension a	Dimension b	UNIT	PU	Contents per PU	Deliv-ery time	Order no. 4004338...
Material: raw steel, Surface: blue galvanised, for screwing in							
10 x 50 mm	60 mm	130 mm	10	Piece	-	L	307219
10 x 60 mm	100 mm	180 mm	10	Piece	-	L	307226
Material: raw steel, Surface: black cataphoretic coating, for screwing in							
10 x 50 mm	60 mm	130 mm	10	Piece	-	L	307141
10 x 60 mm	100 mm	180 mm	10	Piece	-	L	307158

Window shutter stopper, type Marseillais

with countersunk screw holes

Dimension a	Dimension b	Dimension c	UNIT	PU	Contents per PU	Deliv-ery time	Order no. 4004338...
Material: raw steel, Surface: black cataphoretic coating, for screwing on							
50 mm	60 mm	20 mm	10	Piece	-	L	307202

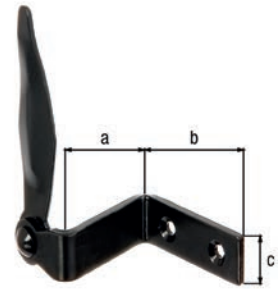

Window shutter stopper, type Marseillais

with wood thread
with adjustable stop
Wooden thread Ø: 10 x 50 mm

Dimension a	UNIT	PU	Contents per PU	Deliv-ery time	Order no. 4004338...
Material: plastic, colour: black, for screwing in					
25 - 70 mm	10	Piece	-	L	308124



Window shutter stopper, type Marseillais

without stop

with concrete anchor made of round steel
Square bar: 8 x 8 mm

Accessory note: suitable stop see article no. 307196, 308445

Dimension a	Dimension b	UNIT	PU	Contents per PU	Deliv-ery time	Order no. 4004338...
Material: raw steel, Surface: blue galvanised, for fixing in a wall						
60 mm	130 mm	10	Piece	-	L	307233
Material: raw steel, Surface: black cataphoretic coating, for sealing						
60 mm	130 mm	10	Piece	-	L	307165

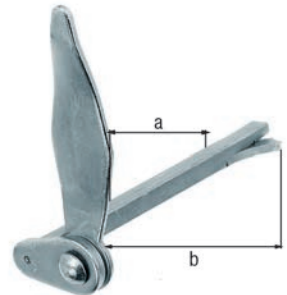

Window shutter stopper with decorative ornament

without stop

with wood thread
Wooden thread Ø: 9 x 60 mm

Accessory note: Suitable stop see item no. 317508

Dimension a	Dimension b	UNIT	PU	Contents per PU	Deliv-ery time	Order no. 4004338...
Material: raw steel, Surface: galvanised, thick-film passivated, for screwing in						
129 mm	77 mm	10	Piece	-	L	314699

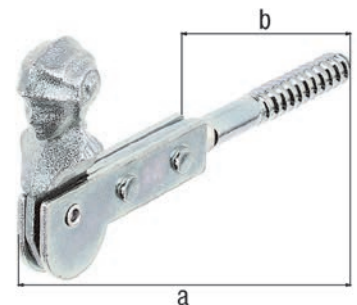

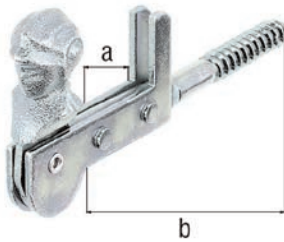

Window shutter stopper with decorative ornament

with stop

with wood thread
Wooden thread Ø: 9 x 60 mm

Dimension a	Dimension b	UNIT	PU	Contents per PU	Deliv-ery time	Order no. 4004338...
Material: raw steel, Surface: galvanised, thick-film passivated, for screwing in						
30 mm	115 mm	10	Piece	-	L	314743

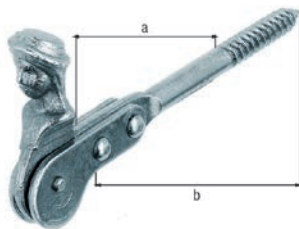

Window shutter stopper with decorative ornament

without stop

with wood thread
Wooden thread Ø: 10 x 50 mm

Accessory note: suitable stop see article no. 307189, 308438

Wooden thread Ø	Dimension a	Dimension b	UNIT	PU	Contents per PU	Deliv-ery time	Order no. 4004338...
Material: raw steel, Surface: blue galvanised, for screwing in							
10 x 50 mm	60 mm	126.5 mm	10	Piece	-	L	307127
Material: raw steel, Surface: black cataphoretic coating, for screwing in							
10 x 50 mm	60 mm	126.5 mm	10	Piece	-	L	307103

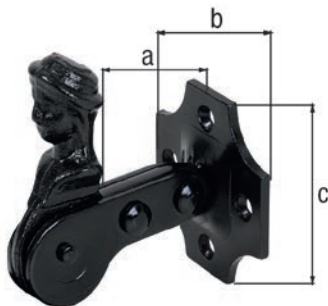

Window shutter stopper with decorative ornament

Dimension a	Dimension b	Dimension c	UNIT	PU	Contents per PU	Deliv-ery time	Order no. 4004338...
Material: raw steel, Surface: black powder-coated							
35 mm	50 mm	55 mm	10	Piece	-	L	307745

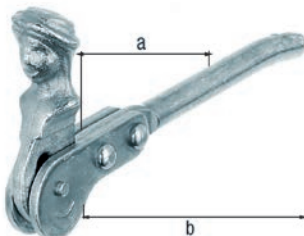

Window shutter stopper with decorative ornament

without stop

with concrete anchor made of round steel

Accessory note: suitable stop see article no. 307189, 308438

Dimension a	Dimension b	UNIT	PU	Contents per PU	Deliv-ery time	Order no. 4004338...
Material: raw steel, Surface: blue galvanised, for fixing in a wall						
60 mm	128.5 mm	10	Piece	-	L	307707
Material: raw steel, Surface: black cataphoretic coating, for sealing						
60 mm	128.5 mm	10	Piece	-	L	307714

Window shutter and door stopper

Type: self-closing

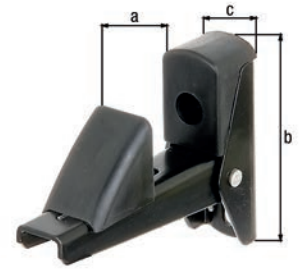

Dimension a	Dimension b	Dimension c	UNIT	PU	Contents per PU	Deliv-ery time	Order no. 4004338...
Material: aluminium, Surface: black painted							
15 - 50 mm	75 mm	25 mm	10	Piece	-	L	307752
Material: aluminium, Surface: white painted							
15 - 50 mm	75 mm	25 mm	10	Piece	-	L	307769

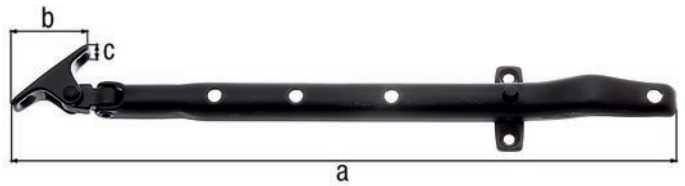

Window stopper for skylight windows or pivot windows

with two retaining pins

Assembly note: Allows the open window to be latched at six different angles and prevents the window from slamming shut.

Dimension a	Dimension b	Dimension c	UNIT	PU	Contents per PU	Deliv-ery time	Order no. 4004338...
Material: raw steel, Surface: black powder-coated							
285 mm	41 mm	15 mm	10	Piece	-	L	210557

Stop for window shutter stoppers

Assembly note: The stop is attached to the shutter lock with the accompanying grub screw.

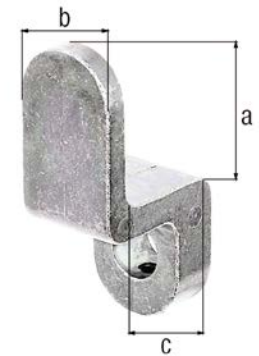

Dimension a	Dimension b	Dimension c	UNIT	PU	Contents per PU	Deliv-ery time	Order no. 4004338...
Material: raw steel, Surface: galvanised, thick-film passivated							
29 mm	20 mm	29 mm	20	Piece	-	L	317508

Stop for window shutter, straight

with wood thread
Wooden thread Ø: 6 x 15 mm
Material thickness: 3.00 mm

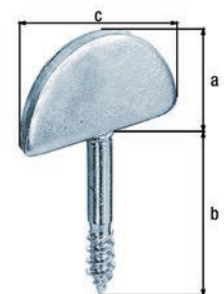

Dimension a	Dimension b	Dimension c	UNIT	PU	Contents per PU	Deliv-ery time	Order no. 4004338...
Material: raw steel, Surface: blue galvanised, for screwing in							
21 mm	34.5 mm	34 mm	25	Piece	-	L	308452
Material: raw steel, Surface: black cataphoretic coating, for screwing in							
21 mm	34.5 mm	34 mm	25	Piece	-	L	307257

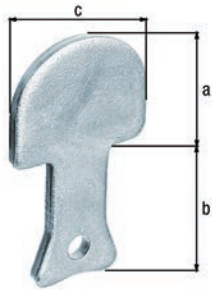

Stop for window shutter, straight

Material thickness: 4.00 mm

Dimension a	Dimension b	Dimension c	UNIT	PU	Contents per PU	Deliv-ery time	Order no. 4004338...
Material: raw steel, Surface: blue galvanised, for fixing in a wall							
28 mm	32 mm	35 mm	25	Piece	-	L	308940
Material: raw steel, Surface: black cataphoretic coating, for sealing							
28 mm	32 mm	35 mm	25	Piece	-	L	307271



Stop for window shutter, angled

with wood thread
Wooden thread Ø: 6 x 15 mm
Material thickness: 3.00 mm

Dimension a	Dimension b	Dimension c	Dimension d	UNIT	PU	Contents per PU	Deliv-ery time	Order no. 4004338...
Material: raw steel, Surface: blue galvanised, for screwing in								
26 mm	35 mm	36 mm	33 mm	25	Piece	-	L	308469
Material: raw steel, Surface: black cataphoretic coating, for screwing in								
26 mm	35 mm	36 mm	33 mm	25	Piece	-	L	307264



Stop for window shutter, angled

Material thickness: 3.00 mm

Dimension a	Dimension b	Dimension c	UNIT	PU	Contents per PU	Deliv-ery time	Order no. 4004338...
Material: raw steel, Surface: black cataphoretic coating, for sealing							
35 mm	65 mm	35 mm	25	Piece	-	L	307318

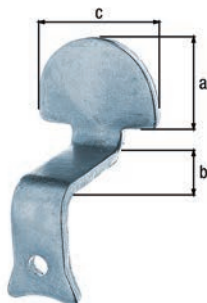

Stop for window shutter, angled

Material thickness: 4.00 mm

Dimension a	Dimension b	Dimension c	UNIT	PU	Contents per PU	Deliv-ery time	Order no. 4004338...
Material: raw steel, Surface: blue galvanised, for fixing in a wall							
25 mm	40 mm	38 mm	25	Piece	-	L	308957
Material: raw steel, Surface: black cataphoretic coating, for sealing							
25 mm	40 mm	38 mm	25	Piece	-	L	307288

Stop for window shutter, angled, attachment at the top

with countersunk screw holes

fitting: at the top

Material thickness: 2.50 mm

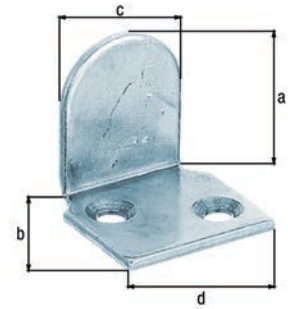

Dimension a	Dimension b	Dimension c	Dimension d	UNIT	PU	Contents per PU	Delivery time	Order no. 4004338...
Material: raw steel, Surface: blue galvanised, for screwing on								
30 mm	28 mm	25 mm	30 mm	25	Piece	-	L	307431
Material: raw steel, Surface: black cataphoretic coating, for screwing on								
30 mm	28 mm	25 mm	30 mm	25	Piece	-	L	307295

Stop for window shutter, angled, attachment at the bottom

with countersunk screw holes

fitting: at the bottom

Material thickness: 2.50 mm

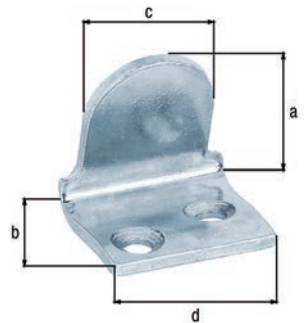

Dimension a	Dimension b	Dimension c	Dimension d	UNIT	PU	Contents per PU	Delivery time	Order no. 4004338...
Material: raw steel, Surface: blue galvanised, for screwing on								
28 mm	26 mm	22.5 mm	29 mm	25	Piece	-	L	307448
Material: raw steel, Surface: black cataphoretic coating, for screwing on								
28 mm	26 mm	22.5 mm	29 mm	25	Piece	-	L	307301

Stop for window shutter stoppers, round, type Marseillais

suitable for window shutter stopper n° 307127, 307707, 307219, 307226, 307103, 307714, 307141, 307158

Material thickness: 2.50 mm

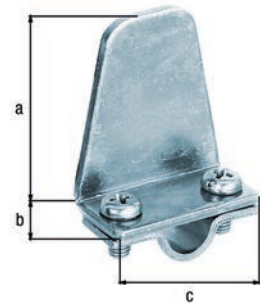

Item description	Dimension a	Dimension b	Dimension c	UNIT	PU	Contents per PU	Delivery time	Order no. 4004338...
Material: raw steel, Surface: blue galvanised								
Mounting plate with round curvature	40 mm	18 mm	35 mm	10	Piece	-	L	308438
Material: raw steel, Surface: black cataphoretic coating								
Mounting plate with round curvature	40 mm	18 mm	35 mm	10	Piece	-	L	307189

Stop for window shutter stoppers, square, type Marseillais

suitable for window shutter stopper n° 307165, 307233

Material thickness: 2.50 mm

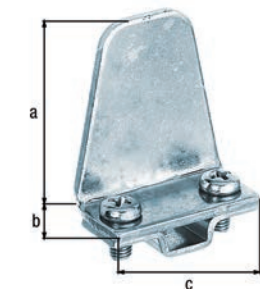

Item description	Dimension a	Dimension b	Dimension c	UNIT	PU	Contents per PU	Delivery time	Order no. 4004338...
Material: raw steel, Surface: blue galvanised								
Mounting plate with angled curvature	40 mm	18 mm	35 mm	10	Piece	-	L	308445
Material: raw steel, Surface: black cataphoretic coating								
Mounting plate with angled curvature	40 mm	18 mm	35 mm	10	Piece	-	L	307196



Latch fastener on plate

with countersunk screw holes

Dimension a	Dimension b	Dimension c	UNIT	PU	Contents per PU	Deliv-ery time	Order no. 4004338...
Material: raw steel, Surface: galvanised, thick-film passivated							
45 mm	20 mm	4.5 mm	20	Piece	-	L	136000

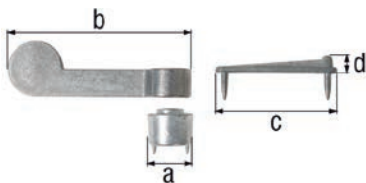

Latch fastener

with strike sheet and spacer

Dimension a-Ø	Dimension b	Dimension c	Dimension d	UNIT	PU	Contents per PU	Deliv-ery time	Order no. 4004338...
Material: die-cast zinc								
10 mm	60 mm	40.3 mm	5 mm	10	Card	2 Piece	L	903664



Fixing plate for the fixation of window shutters on the wall

Length: 75 mm
Width: 32 mm

Assembly note: With fixing plate and flat head screws the shutters can be mounted on the house wall for decoration.

UNIT	PU	Contents per PU	Delivery time	Order no. 4004338...
Material: stainless steel				
50	Piece	-	L	316907



Fixing set type Picarde

for wooden covers on doors and windows
with countersunk screw holes

Set components: One set consists of four angles, four tabs and 16 screws

UNIT	PU	Contents per PU	Delivery time	Order no. 4004338...
Material: raw steel, Surface: blue galvanised				
6	Card	4 Set	L	309336

SCREWS AND ACCESSORIES

Made to last.

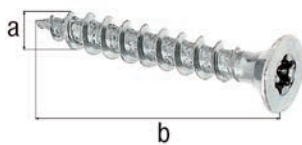

Wood screw Mini-Fix

suitable for caps for timber posts, fence bracket and other fittings with \varnothing 3.6 - 5 mm fixing holes countersunk with six lobe drive

	Item description	Dimension a- \varnothing	Dimension b	UNIT	PU	Contents per PU	Deliv-ery time	Order no. 4004338...
	Material: raw steel, Surface: blue galvanised, in hanging box							
→	Without bit	3.5 mm	25 mm	4	Pack	16 Piece	L	338770
	Material: stainless steel, in hanging box							
→ VA	Without bit	3.5 mm	25 mm	4	Pack	16 Piece	L	338787

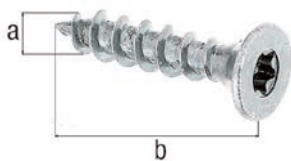

Wood screw Medi-Fix

suitable for fittings with \varnothing 5.1 - 7 mm fixing holes countersunk with six lobe drive

	Item description	Dimension a- \varnothing	Dimension b	UNIT	PU	Contents per PU	Deliv-ery time	Order no. 4004338...
	Material: raw steel, Surface: blue galvanised, in hanging box							
→	Without bit	5 mm	25 mm	4	Pack	16 Piece	L	338756
	Material: stainless steel, in hanging box							
→ VA	Without bit	5 mm	25 mm	4	Pack	16 Piece	L	338763

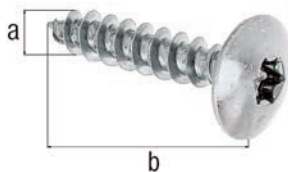

Wood screw Maxi-Fix

suitable for shutter hinges, hooks, tee hinges and strap hinges, middle and corner hinges truss head with six lobe drive size 30

	Dimension a- \varnothing	Dimension b	UNIT	PU	Contents per PU	Deliv-ery time	Order no. 4004338...
	Material: raw steel, Surface: blue galvanised, in hanging box						
→	6 mm	30 mm	4	Pack	4 Piece	L	338275
→	6 mm	50 mm	4	Pack	4 Piece	L	338299
	Material: stainless steel, in hanging box						
→ VA	6 mm	30 mm	4	Pack	4 Piece	L	338282
→ VA	6 mm	50 mm	4	Pack	4 Piece	L	338305

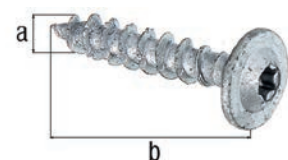

Wood screw Speed

suitable for post supports, fence post spikes and ground screws with six lobe drive size 30

	Dimension a- \varnothing	Dimension b	UNIT	PU	Contents per PU	Deliv-ery time	Order no. 4004338...
	Material: raw steel, Surface: zinc-aluminium slat coating, silver, in hanging box						
→	7 mm	40 mm	4	Pack	4 Piece	L	338220
→	7 mm	50 mm	4	Pack	4 Piece	L	338237
	Material: raw steel, Surface: zinc-aluminium slat coating, silver, in bargain pack						
GP	7 mm	40 mm	3	Pack	50 Piece	L	338381
GP	7 mm	50 mm	3	Pack	50 Piece	L	338398

Round-head screw Multi-Fix

with sleeve nut

for frame thicknesses including fitting of 27 - 45 mm (shutter hinges, tee hinges and strap hinges, middle and corner hinges)
 flat head screw with six lobe drive according to DIN 603 with continuous thread
 with six lobe drive size 30
 suitable for square holes, 9 x 9 mm
 disc according to DIN 125
 Disc internal Ø: 10.5 mm
 Disc external Ø: 20 mm
 Screw length: 30 mm
 Screw: M8
 Lug: 8.5 x 8.5 mm
 Sleeve nut: M8 x 25 mm

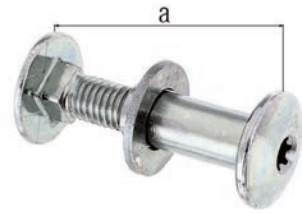

Dimension a	UNIT	PU	Contents per PU	Deliv-ery time	Order no. 4004338...
Material: raw steel, Surface: blue galvanised, in hanging box					
50 mm	4	Pack	2 Piece	L	338312

Hexagon head screw, D-Fix

for H post supports, U post supports etc.

as per DIN 601, with hexagon nut as per DIN 934 and disc as per DIN 9021
 Disc internal Ø: 10.5 mm
 Disc external Ø: 30 mm
 Thread: M10
 Hex nut: M10

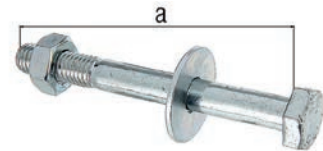

Dimension a	UNIT	PU	Contents per PU	Deliv-ery time	Order no. 4004338...
Material: raw steel, Surface: blue galvanised, in hanging box					
90 mm	4	Pack	2 Piece	L	338251
110 mm	4	Pack	2 Piece	L	338268

Spacer sleeve for screws

For Ø: 5 - 8 mm

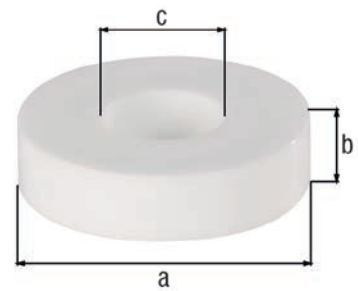

Dimension a-Ø	Dimension b	Dimension c-Ø	UNIT	PU	Contents per PU	Deliv-ery time	Order no. 4004338...
Material: plastic (polystyrene), colour: white							
20 mm	5 mm	8.5 mm	4	Pack	20 Piece	L	338657
20 mm	10 mm	8.5 mm	4	Pack	15 Piece	L	338671
20 mm	20 mm	8.5 mm	4	Pack	10 Piece	L	338695

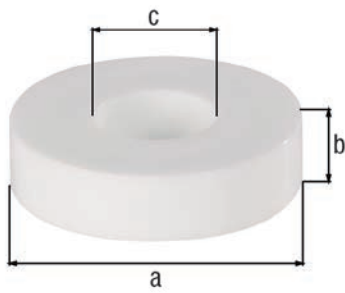

Spacer sleeve set for screws

For \varnothing : 5 - 8 mm

Set components: One set consists of five pieces for each height

	Dimension a- \varnothing	Dimension b	Dimension c- \varnothing	UNIT	PU	Contents per PU	Deliv-ery time	Order no. 4004338...
	Material: plastic (polystyrene), colour: black							
☛	20 mm	5 / 10 / 20 / 30 mm	8.5 mm	4	Pack	5 Piece	L	338725
	Material: plastic (polystyrene), colour: white							
☛	20 mm	5 / 10 / 20 / 30 mm	8.5 mm	4	Pack	5 Piece	L	338718

METAL GATE FITTINGS

Made to last.

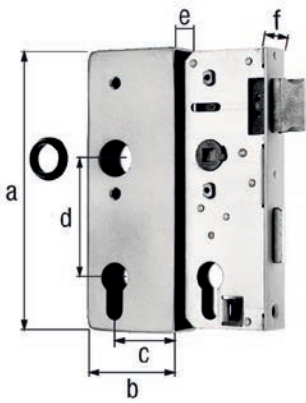

Lock case with galvanised lock

with countersunk screw holes
backset 40 mm

applicable DIN left and right
PC perforation
with switch-over
1-level
with two plastic guides for 18 mm lug
Strike plate height: 166 mm
Protruding lock latch: 5 mm
Socket: 8 x 8 mm

Assembly note: The lock can be switched to the opposite opening direction (DIN left/DIN right) by inserting a screwdriver in the notch in the latch bolt, then pressing the latch forward and turning through 180°.

Dimension a	Dimension b	Dimension c	Dimension d	Dimension e	Dimension f	UNIT	PU	Contents per PU	Deliv-ery time	Order no. 4004338...
170 mm	60 mm	40 mm	72 mm	30 mm	24 mm	1	Piece	-	L	413354

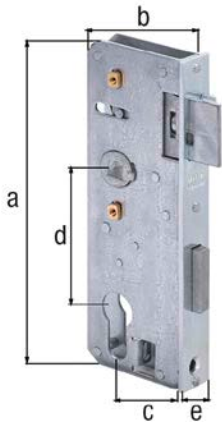

Replacement lock

with countersunk screw holes
backset 40 mm

suitable for lock case no. 413354
For lock casing: 30 mm

Dimension a	Dimension b	Dimension c	Dimension d	Dimension e	Dimension f	UNIT	PU	Contents per PU	Deliv-ery time	Order no. 4004338...
166 mm	54 mm	40 mm	72 mm	24 mm	166 mm	1	Piece	-	L	413378

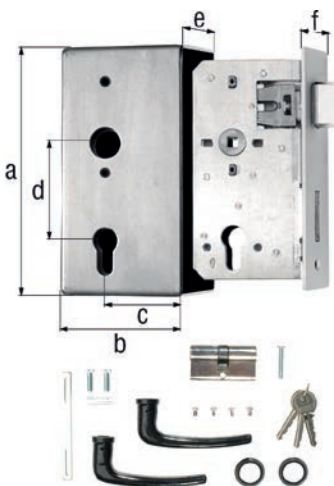

Lock case with galvanised lock

with countersunk screw holes
backset 55 mm

applicable DIN left and right
Strike plate height: 180.8 mm

Assembly note: The lock can be switched to the opposite opening direction (DIN left/DIN right) by inserting a screwdriver in the notch in the latch bolt, then pressing the latch forward and turning through 180°.

Set components: One set consists of one door handle, profile cylinder 60 mm with three keys, two door handle guides made of black plastic and four stainless steel screws.

Dimension a	Dimension b	Dimension c	Dimension d	Dimension e	Dimension f	UNIT	PU	Contents per PU	Deliv-ery time	Order no. 4004338...
185 mm	90 mm	55 mm	72 mm	40 mm	33 mm	1	Piece	-	L	418700

Lock case with galvanised lock

with countersunk screw holes
backset 55 mm

applicable DIN left and right
PC perforation
with switch-over
1-level
with two plastic guides for 18 mm lug
Strike plate height: 180 mm
Protruding lock latch: 5 mm
Socket: 8 x 8 mm

Assembly note: The lock can be switched to the opposite opening direction (DIN left/DIN right) by inserting a screwdriver in the notch in the latch bolt, then pressing the latch forward and turning through 180°.

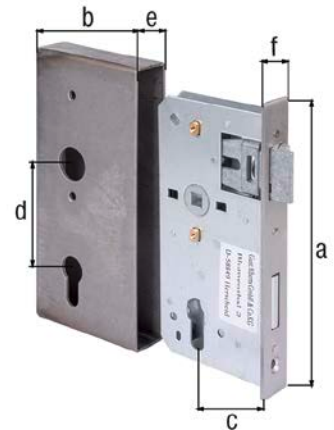

Dimension a	Dimension b	Dimension c	Dimension d	Dimension e	Dimension f	UNIT	PU	Contents per PU	Delivery time	Order no. 4004338...
Material: case: raw steel, lock: raw steel, Surface: lock: galvanised										
185 mm	90 mm	55 mm	72 mm	30 mm	24.0 mm	1	Box	-	L	413408
185 mm	90 mm	55 mm	72 mm	34 mm	28.5 mm	1	Piece	-	L	413415
185 mm	90 mm	55 mm	72 mm	40 mm	33.0 mm	1	Box	-	L	413422

Replacement lock

backset 55 mm

suitable for lock case nos. 413408, 413415, 413422, 413453, 413460, 418700

For lock casing	Dimension a	Dimension b	Dimension c	Dimension d	Dimension e	Dimension f	UNIT	PU	Contents per PU	Delivery time	Order no. 4004338...
Material: raw steel, Surface: galvanised											
30 mm	167 mm	85 mm	55 mm	72 mm	24.0 mm	180 mm	1	Piece	-	L	416102
34 mm	167 mm	85 mm	55 mm	72 mm	28.5 mm	180 mm	1	Piece	-	L	416119
40 mm	167 mm	85 mm	55 mm	72 mm	33.0 mm	180 mm	1	Piece	-	L	416126

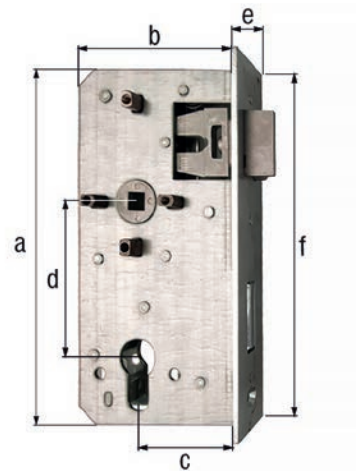

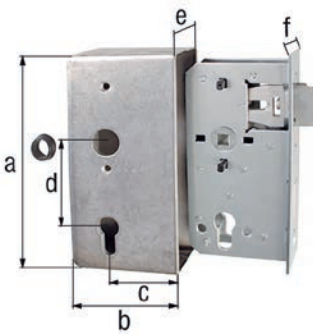

Lock case with galvanised lock

with countersunk screw holes
backset 55 mm

applicable DIN left and right
PC perforation
with switch-over
2-level
with two plastic guides for 18 mm lug
Strike plate height: 180 mm
Socket: 8.8 x 8.8 mm

Assembly note: The lock can be switched to the opposite opening direction (DIN left/DIN right) by inserting a screwdriver in the notch in the latch bolt, then pressing the latch forward and turning through 180°.

Dimension a	Dimension b	Dimension c	Dimension d	Dimension e	Dimension f	UNIT	PU	Contents per PU	Deliv-ery time	Order no. 4004338...
Material: case: raw steel, lock: raw steel, Surface: lock: galvanised										
185 mm	90 mm	55 mm	72 mm	30 mm	24 mm	1	Box	-	L	413453
185 mm	90 mm	55 mm	72 mm	40 mm	33 mm	1	Box	-	L	413460

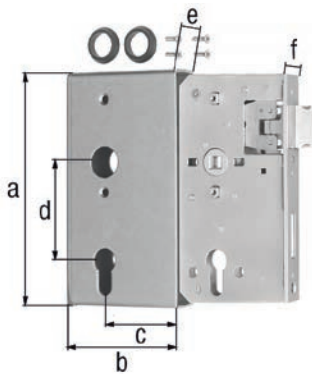

Lock case with galvanised lock

with countersunk screw holes
backset 60 mm

applicable DIN left and right
PC perforation
with switch-over
2-level
with lubricating nipple
with two plastic guides for 18 mm lug
Strike plate height: 167 mm
Protruding lock latch: 0 - 5 mm
Socket: 8 x 8 mm

Assembly note: The lock can be switched to the opposite opening direction (DIN left/DIN right) by inserting a screwdriver in the notch in the latch bolt, then pressing the latch forward and turning through 180°.

Dimension a	Dimension b	Dimension c	Dimension d	Dimension e	Dimension f	UNIT	PU	Contents per PU	Deliv-ery time	Order no. 4004338...
Material: case: raw steel, lock: raw steel, Surface: lock: galvanised										
172 mm	94 mm	60 mm	72 mm	30 mm	24.0 mm	1	Piece	-	L	417031
172 mm	94 mm	60 mm	72 mm	40 mm	33.0 mm	1	Piece	-	L	417055

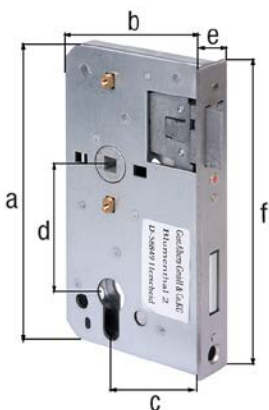

Replacement lock

with countersunk screw holes
backset 60 mm

suitable for lock case nos. 417031, 417048, 417055

Dimension a	Dimension b	Dimension c	Dimension d	Dimension e	Dimension f	UNIT	PU	Contents per PU	Deliv-ery time	Order no. 4004338...
Material: raw steel, Surface: galvanised										
167 mm	90 mm	60 mm	72 mm	24.0 mm	167 mm	1	Piece	-	L	417093
167 mm	90 mm	60 mm	72 mm	33.0 mm	167 mm	1	Piece	-	L	417116

Lock case with galvanised lock

with countersunk screw holes
backset 65 mm

applicable DIN left and right
PC perforation
with switch-over
1-level
with two plastic guides for 18 mm lug
Strike plate height: 180.2 mm
Protruding lock latch: 5 mm
Socket: 8 x 8 mm

Assembly note: The lock can be switched to the opposite opening direction (DIN left/DIN right) by inserting a screwdriver in the notch in the latch bolt, then pressing the latch forward and turning through 180°.

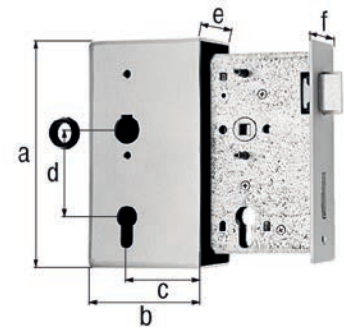

Dimension a	Dimension b	Dimension c	Dimension d	Dimension e	Dimension f	UNIT	PU	Contents per PU	Delivery time	Order no. 4004338...
Material: case: raw steel, lock: raw steel, Surface: lock: galvanised										
190 mm	100 mm	65 mm	72 mm	50 mm	43 mm	1	Piece	-	L	412050
190 mm	100 mm	65 mm	72 mm	60 mm	53 mm	1	Box	-	L	412067

Replacement lock

with countersunk screw holes
backset 65 mm

suitable for lock case nos. 412050 and 412067

Dimension a	Dimension b	Dimension c	Dimension d	Dimension e	Dimension f	UNIT	PU	Contents per PU	Delivery time	Order no. 4004338...
Material: raw steel, Surface: galvanised										
164 mm	98 mm	65 mm	72 mm	43 mm	180.2 mm	1	Piece	-	L	412036
164 mm	98 mm	65 mm	72 mm	53 mm	180.2 mm	1	Piece	-	L	412043

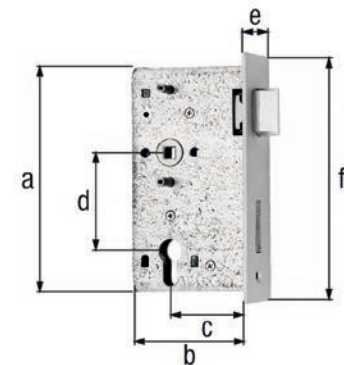

Tube frame lock

with countersunk screw holes
backset 25 mm

suitable for square tube no. 413132
applicable DIN left and right
PC perforation
with switch-over
1-level
with plastic cuff
Socket: 8 x 8 mm

Dimension a	Dimension b	Dimension c	Dimension d	Dimension e	Dimension f	UNIT	PU	Contents per PU	Delivery time	Order no. 4004338...
Material: raw steel, Surface: galvanised										
197 mm	38 mm	25 mm	72 mm	24 mm	243 mm	1	Piece	-	L	413057

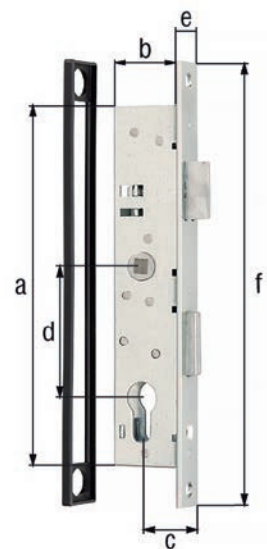

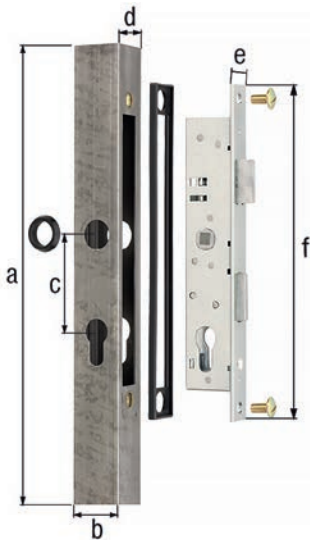

Square tubing with frame lock

backset 25 mm
 applicable DIN left and right
 PC perforation
 with switch-over
 1-level
 with two plastic guides for 18 mm lug
 Protruding lock latch: 5 mm
 Socket: 8 x 8 mm

Assembly note: The locks are set to DIN left as standard; to switch to DIN right: Press the lever on the back of the lock upwards and reverse the position of the latch.

Dimension a	Dimension b	Dimension c	Dimension d	Dimension e	Dimension f	UNIT	PU	Contents per PU	Deliv-ery time	Order no. 4004338...
500 mm	40 mm	72 mm	40 mm	24 mm	243 mm	1	Collar	-	L	413132

Material: rectangular tube: raw steel, Surface: lock: galvanised for welding on

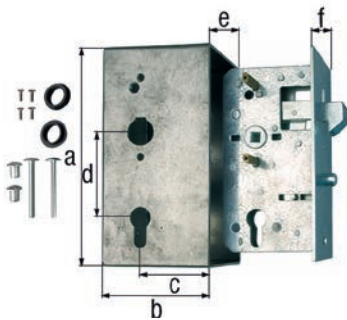

Lock case with galvanised lock for sliding gates

with hook latch
 backset 60 mm
 with countersunk screw holes
 applicable DIN left and right
 PC perforation
 with switch-over
 with two plastic guides for 18 mm lug
 lock also locked with two through bolts
 Socket: 8 x 8 mm

Dimension a	Dimension b	Dimension c	Dimension d	Dimension e	Dimension f	UNIT	PU	Contents per PU	Deliv-ery time	Order no. 4004338...
173 mm	95 mm	60 mm	72 mm	40 mm	33 mm	1	Box	-	L	413750

Material: case: raw steel, lock: raw steel, Surface: lock: galvanised

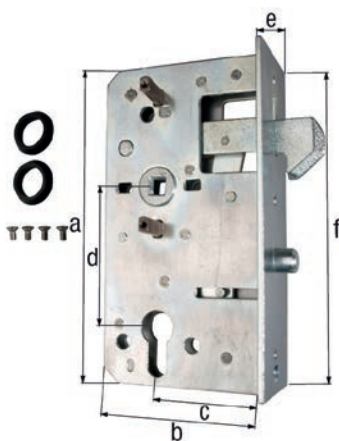

Replacement lock

with hook latch
 backset 60 mm
 with countersunk screw holes
 suitable for lock case no. 413750
 For lock casing: 60 mm
 Socket: 8 x 8 mm

Dimension a	Dimension b	Dimension c	Dimension d	Dimension e	Dimension f	UNIT	PU	Contents per PU	Deliv-ery time	Order no. 4004338...
167 mm	90 mm	60 mm	72 mm	33 mm	167 mm	1	Piece	-	L	416447

Material: raw steel, Surface: galvanised

Stop for sash lock boxes

with countersunk screw holes

suitable for electric door opener nos. 413842 and 413859.
 suitable for all lock cases with a depth of 40 mm
 applicable DIN left and right
 prepared for electrical door openers

Accessory note: Electric door opener not included.

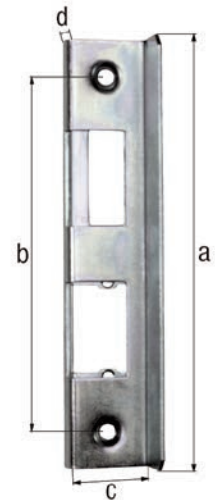

Dimension a	Dimension b	Dimension c	Dimension d	UNIT	PU	Contents per PU	Deliv-ery time	Order no. 4004338...
Material: raw steel, Surface: galvanised, thick-film passivated, for screwing on								
235.5 mm	196 mm	43 mm	20 mm	1	Piece	-	L	412302

Stop for sash lock boxes

with countersunk screw holes

suitable for all lock cases with a depth of 30 - 40 mm
 suitable for round and rectangular tubes, second gate leaves and wall columns
 applicable DIN left and right
 with rubber buffers for quiet closing

Set components: One set consists of one lower section, one stop bracket and two raised countersunk head screws, with suitable plugs

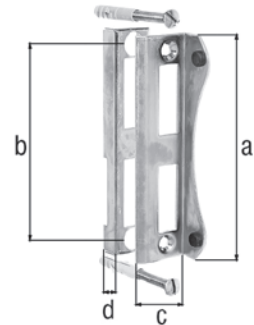

Dimension a	Dimension b	Dimension c	Dimension d	UNIT	PU	Contents per PU	Deliv-ery time	Order no. 4004338...
Material: raw steel, Surface: galvanised								
188 mm	162 mm	30 mm	20 mm	1	Bag	-	L	412081
188 mm	162 mm	40 mm	20 mm	1	Bag	-	L	412104

Stop for sash lock boxes

with countersunk screw holes

suitable for all lock cases with a depth of 30 - 40 mm

Assembly note: The stop can be either screwed on or embedded in concrete; if concrete is used, the masonry anchors must first be screwed into the welded nuts.

Accessory note: Wall anchors, screws, and plugs packed in a bag included.

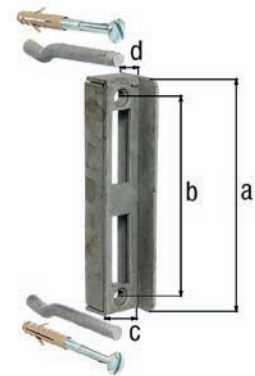

Dimension a	Dimension b	Dimension c	Dimension d	UNIT	PU	Contents per PU	Deliv-ery time	Order no. 4004338...
Material: raw steel, Surface: hot-dip galvanised								
172 mm	146 mm	30 mm	25 mm	1	Bag	-	L	412319
172 mm	146 mm	34 mm	25 mm	1	Bag	-	L	412326
172 mm	146 mm	40 mm	25 mm	1	Bag	-	L	412333

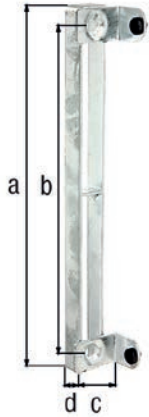

Stop for gates with frame

with countersunk screw holes

suitable for all lock cases with a depth of 40 mm
 applicable DIN left and right
 with rubber buffers for quiet closing

Accessory note: Mounted rubber bumpers included.

Dimension a	Dimension b	Dimension c	Dimension d	UNIT	PU	Contents per PU	Deliv-ery time	Order no. 4004338...
Material: raw steel, Surface: hot-dip galvanised								
295 mm	266 mm	24 mm	15 mm	1	Piece	-	L	413125

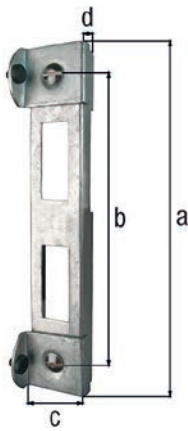

Stop for tubing sections

suitable for square tube no. 413132
 applicable DIN left and right
 with rubber buffers for quiet closing

Set components: One set consists of one lower section, two stop brackets and raised countersunk head screws, with fitting plugs

Dimension a	Dimension b	Dimension c	Dimension d	UNIT	PU	Contents per PU	Deliv-ery time	Order no. 4004338...
Material: raw steel, Surface: hot-dip galvanised								
235 mm	195 mm	40 mm	22 mm	1	Piece	-	L	412401



Strike box for lock cases for electric door openers

with countersunk screw holes

suitable for all lock cases with a depth of 30 - 40 mm
 applicable DIN left and right

Dimension a	Dimension b	Dimension c	Dimension d	UNIT	PU	Contents per PU	Deliv-ery time	Order no. 4004338...
Material: raw steel, for welding								
185 mm	47 mm	42 mm	18 mm	1	Piece	-	L	417383

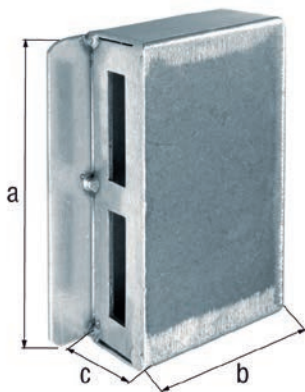

Strike box for lock cases

for double gates
 applicable DIN left and right

Dimension a	Dimension b	Dimension c	UNIT	PU	Contents per PU	Deliv-ery time	Order no. 4004338...
Material: raw steel, for welding							
188 mm	89 mm	40 mm	1	Piece	-	L	413668

Door handle

suitable for 30 - 60 mm frame thickness

Accessory note: 8 x 8 mm square pin, threaded pin, and hole part included.



For lock casing	Dimension a	Dimension b	UNIT	PU	Contents per PU	Deliv-ery time	Order no. 4004338...
Material: aluminium, Surface: silver anodised							
30 - 40 mm	56 mm	115 mm	1	Pair	2 Piece	L	412647
50 - 60 mm	56 mm	115 mm	1	Pair	2 Piece	L	412661

Door handle

suitable for 30 mm frame thickness

Width: 115 mm

Distance: 50 mm

Accessory note: 8 x 8 mm square pin, threaded pin, and hole part included.



UNIT	PU	Contents per PU	Delivery time	Order no. 4004338...
Material: cast aluminium				
1	Pair	2 Piece	L	554880

Door handle

suitable for 40 - 65 mm frame thickness

Accessory note: 8 x 8 mm square pin, grub screw, and Allen key included.



Dimension a	Dimension b	UNIT	PU	Contents per PU	Deliv-ery time	Order no. 4004338...
Material: aluminium, Surface: black anodised						
50 mm	115 mm	1	Pair	2 Piece	L	654047

Door handle

suitable for 35 - 50 mm frame thickness

Accessory note: 8 x 8 mm square pin included



Dimension a	Dimension b	UNIT	PU	Contents per PU	Deliv-ery time	Order no. 4004338...
Material: aluminium						
40 mm	107.5 mm	1	Bag	2 Piece	L	419035

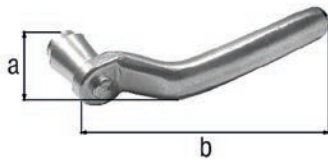

Door handle

usable on the right and left

Dimension a	Dimension b	UNIT	PU	Contents per PU	Deliv-ery time	Order no. 4004338...
Material: raw steel, Surface: galvanised, silver grey stove enamelled						
45 mm	120 mm	1	Piece	-	S	416515



Door handle

suitable for 33 - 65 mm frame thickness

Width: 115 mm

Distance: 40 mm

Accessory note: 8 x 8 mm square pin, threaded pin, and hole part included.

UNIT	PU	Contents per PU	Delivery time	Order no. 4004338...	
Material: raw steel, Surface: forged, galvanised, silver grey stove enamelled					
15	1	Pair	2 Piece	L	554293



Protective plate

with countersunk screw holes

suitable for door handle no. 554293

Length: 155 mm

Width: 30 mm

Material thickness: 6.00 mm

Distance: 72 mm

Accessory note: Stainless steel fixing screws included.

UNIT	PU	Contents per PU	Delivery time	Order no. 4004338...	
Material: raw steel, Surface: forged, galvanised, silver grey stove enamelled					
15	1	Pair	2 Piece	L	554309

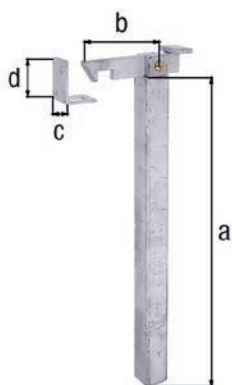

Gate stop for fixing in the ground

with counterplate for screwing on

can be adjusted by: 120 mm

Plate thickness: 3 mm

Dimension a	Dimension b	Dimension c	Dimension d	UNIT	PU	Contents per PU	Deliv-ery time	Order no. 4004338...
Material: raw steel, Surface: hot-dip galvanised, for setting in concrete								
300 mm	90 mm	30 mm	50 mm	1	Piece	-	L	412838

Gate stop for fixing in the ground

with counterplate for screwing on

Plate thickness: 4 mm

Dimension a	Dimension b	Dimension c	Dimension d	Dimension e	Dimension f	UNIT	PU	Contents per PU	Delivery time	Order no. 4004338...
Material: grey cast iron, Surface: blue galvanised, for setting in concrete										
168 mm	52 mm	35 mm	34 mm	71 mm	124 mm	5	Piece	-	L	412814
191 mm	52 mm	35 mm	34 mm	71 mm	150 mm	5	Piece	-	L	412821

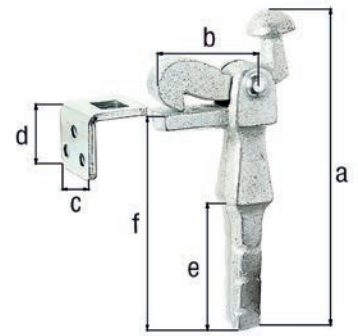

Gate stop for fixing on the wall

with countersunk screw holes

with counter plate

Dimension a	Dimension b	Dimension c	UNIT	PU	Contents per PU	Delivery time	Order no. 4004338...
Material: raw steel, Surface: hot-dip galvanised, for screwing on							
100 mm	65 mm	50 mm	1	Piece	-	L	411756

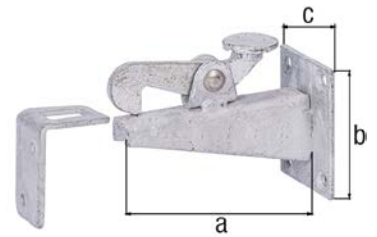

Gate stop for fixing on the ground

with countersunk screw holes

with counter plate

Dimension a	Dimension b	Dimension c	UNIT	PU	Contents per PU	Delivery time	Order no. 4004338...
Material: raw steel, Surface: hot-dip galvanised, for screwing on							
95 mm	65 mm	50 mm	1	Piece	-	L	411763

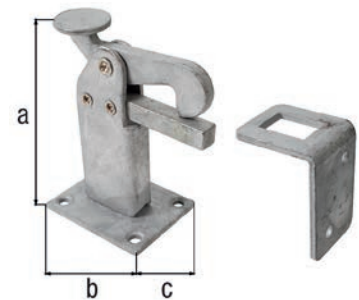

Drop bolt

Dimension a	Dimension b-Ø	Dimension c	Dimension d	Dimension e	UNIT	PU	Contents per PU	Delivery time	Order no. 4004338...
Material: raw steel, Surface: galvanised, thick-film passivated, for welding on									
400 mm	18 mm	125 mm	50 mm	160 mm	1	Piece	-	L	410216

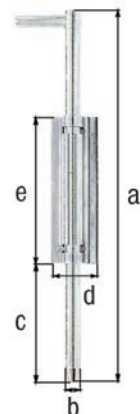

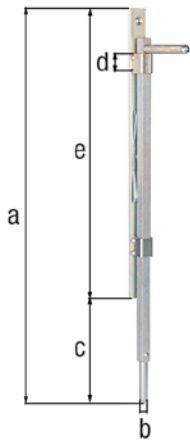

Drop bolt for wooden and metal gates

with countersunk screw holes

The drop bolt is held at the set height by a spring.
Drop bolt end piece-Ø: 12 x 60 mm
Hole: M6

Assembly note: The low installed height of just 25 mm and the ability to turn the actuating handle mean that it can be fitted in almost all rectangular and triangular tubes.

Dimension a	Dimension b	Dimension c	Dimension d	Dimension e	UNIT	PU	Contents per PU	Deliv-ery time	Order no. 4004338...
500 mm	14 x 14 mm	150 mm	25 mm	390 mm	1	Piece	-	L	416805

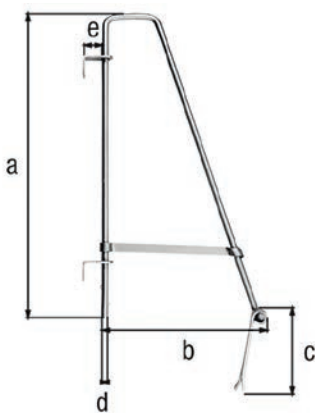

Drop bolt, type triangular

with two guide brackets for welding

Length of latch in the concrete anchor: 150 mm

Accessory note: Concrete anchor included.

Dimension a	Dimension b	Dimension c	Dimension d-Ø	Dimension e	UNIT	PU	Contents per PU	Deliv-ery time	Order no. 4004338...
700 mm	360 mm	170 mm	16 mm	40 mm	1	Piece	-	S	410568

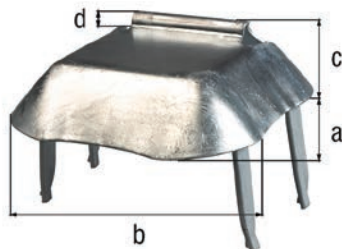

Gate stop

with four welded on concrete anchors

Type: not drilled
Concrete anchor: 20 x 120 x 5 mm

Dimension a	Dimension b	Dimension c	Dimension d	UNIT	PU	Contents per PU	Deliv-ery time	Order no. 4004338...
210 mm	205 mm	55 mm	10 mm	1	Piece	-	L	410445

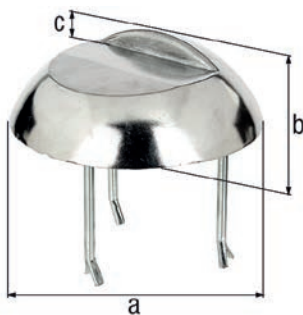

Gate stop

Type: not drilled
depth of encase in concrete: 125 mm

· The rounded form of this gate stop prevents tyres from being damaged when they roll over it.

Accessory note: Three screw-on concrete anchors included.

Dimension a-Ø	Dimension b	Dimension c	UNIT	PU	Contents per PU	Deliv-ery time	Order no. 4004338...
205 mm	65 mm	17 mm	1	Piece	-	L	410476

Lifting gate fitting for metal gates

for uneven terrain

applicable DIN left and right
 max. load: 100 kg at 2.50 m width of the gate wings
 the gate can open more than 90°
 The gate rises when opened. The incline (up to 7°) can be adjusted at different positions and depends on the size of the gate.

Assembly note: A square post at least 80 mm wide is required for assembly.

Set components: One set for a gate leaf consists of one upper and one lower weld-on strip, two weld-on plates, two ball angle joints, greased, galvanised, fixing screws, and assembly instructions. Packed in a polybag.



UNIT	PU	Contents per PU	Delivery time	Order no.
1	Box	-	L	411725

Material: fittings: raw steel, Surface: ball angle joint and fastening material: galvanised, for welding on

Gate track roller for light gates

for gates weighing up to 70 kg

the spring-loaded telescopic leg with a spring travel of up to 60 mm serves to smooth out any unevennesses in the gate entrance

Dimension a	Dimension b-Ø	Dimension c	Dimension d	Dimension e	UNIT	PU	Contents per PU	Deliv-ery time	Order no.
400 mm	100 mm	30 mm	255 mm	225 mm	1	Piece	-	L	416850

Material: raw steel, Surface: hot-dip galvanised, for screwing on

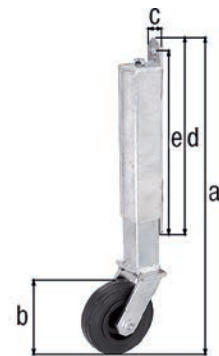

Gate track roller for heavy gates

for gates weighing up to 450 kg

the spring-loaded telescopic leg with a spring travel of up to 60 mm serves to smooth out any unevennesses in the gate entrance

Dimension a	Dimension b-Ø	Dimension c	Dimension d	Dimension e	UNIT	PU	Contents per PU	Deliv-ery time	Order no.
400 mm	125 mm	130 mm	30 mm	150 mm	1	Piece	-	L	416867

Material: raw steel, Surface: hot-dip galvanised, for screwing on

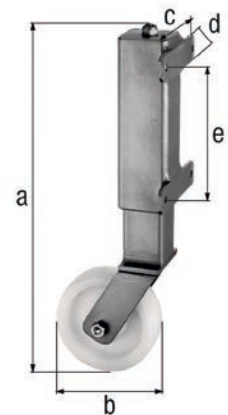

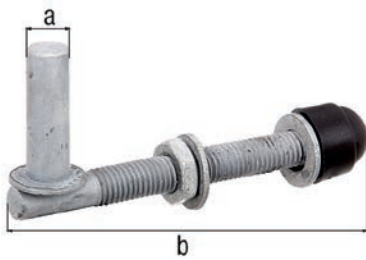

Hook for screwing in

Type: adjustable

Assembly note: Easily adjustable, even after assembly.

Accessory note: Two nuts and washers included.

Dimension a-Ø	Dimension b	Thread	UNIT	PU	Contents per PU	Deliv-ery time	Order no. 4004338...
Material: raw steel, Surface: hot-dip galvanised, packed in bag							
13 mm	120 mm	M12	1	Pair	-	L	410643
13 mm	140 mm	M12	1	Pair	-	L	410650
16 mm	140 mm	M12	1	Pair	-	L	410674
16 mm	190 mm	M16	1	Pair	-	L	410803

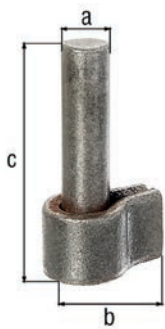

Hook

Dimension a-Ø	Dimension b	Dimension c	UNIT	PU	Contents per PU	Deliv-ery time	Order no. 4004338...
Material: raw steel, for welding							
13 mm	24 mm	65 mm	10	Piece	-	L	411008
16 mm	30 mm	75 mm	10	Piece	-	L	411015
20 mm	50 mm	95 mm	1	Piece	-	L	411022

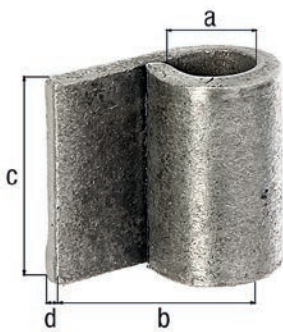

Weld-on hinge

Dimension a-Ø	Dimension b	Dimension c	Dimension d	UNIT	PU	Contents per PU	Deliv-ery time	Order no. 4004338...
Material: raw steel, for welding								
13 mm	30 mm	40 mm	5 mm	1	Piece	-	L	411367
13 mm	80 mm	40 mm	5 mm	10	Piece	-	L	411374
16 mm	25 mm	45 mm	5 mm	1	Piece	-	L	411381
16 mm	75 mm	45 mm	5 mm	10	Piece	-	L	411398
20 mm	100 mm	60 mm	8 mm	1	Piece	-	L	411404

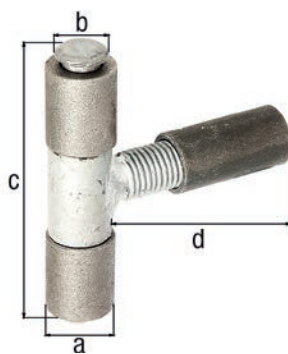

Weld-on hinge, adjustable

with threaded sleeve for welding
with lubricating hole
can be adjusted by: 40 mm

Accessory note: Threaded sleeve included.

Thread	Dimension a-Ø	Dimension b-Ø	Dimension c	Dimension d	Max. load capacity	UNIT	PU	Contents per PU	Deliv-ery time	Order no. 4004338...
Material: raw steel, Surface: galvanised pin and middle part, for welding on										
M16	22 mm	12 mm	87 mm	90 mm	100 kg	4	Piece	-	L	411558
M20	27 mm	15 mm	90 mm	92 mm	150 kg	4	Piece	-	L	411565
M24	32 mm	20 mm	95 mm	95 mm	200 kg	4	Piece	-	L	411572

Construction hinge, two parts, type KO4

Dimension a	Dimension b	Dimension c-Ø	Dimension d	Material thickness	UNIT	PU	Contents per PU	Delivery time	Order no. 4004338...
Material: raw steel, for welding									
80 mm	30 mm	9 mm	40 mm	3.00	10	Piece	-	L	414405
100 mm	30 mm	9 mm	50 mm	3.00	10	Piece	-	L	414412
120 mm	30 mm	9 mm	60 mm	3.00	10	Piece	-	L	414429
140 mm	50 mm	14 mm	70 mm	4.00	10	Piece	-	L	414436
160 mm	50 mm	14 mm	80 mm	4.00	10	Piece	-	L	414443
160 mm	50 mm	16 mm	80 mm	5.00	6	Piece	-	L	414450
180 mm	50 mm	14 mm	90 mm	4.00	10	Piece	-	L	414467
Material: stainless steel, for welding									
80 mm	30 mm	9 mm	40 mm	3.00	10	Piece	-	L	414306 VA
100 mm	30 mm	9 mm	50 mm	3.00	10	Piece	-	L	414313 VA
120 mm	30 mm	9 mm	60 mm	3.00	10	Piece	-	L	414320 VA
160 mm	50 mm	14 mm	80 mm	4.00	10	Piece	-	L	414337 VA
180 mm	50 mm	14 mm	90 mm	4.00	10	Piece	-	L	414344 VA

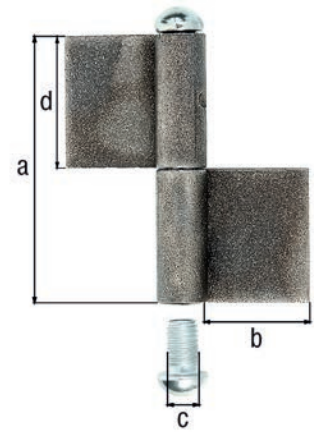

Construction hinge, three parts, type KO8

Dimension a	Dimension b	Dimension c-Ø	Dimension d	Dimension e	Material thickness	UNIT	PU	Contents per PU	Delivery time	Order no. 4004338...
Material: raw steel, for welding										
220 mm	50 mm	14 mm	70 mm	80 mm	4.00 mm	6	Piece	-	L	414474
240 mm	50 mm	16 mm	70 mm	100 mm	5.00 mm	6	Piece	-	L	414481
260 mm	50 mm	16 mm	80 mm	100 mm	5.00 mm	6	Piece	-	L	414498

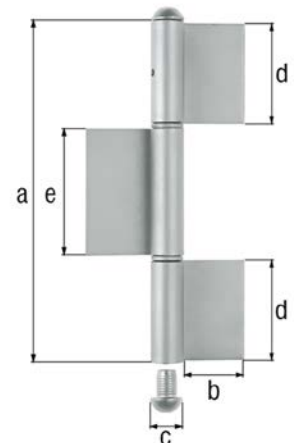

Gate hinge with U-bracket and welding nut for welding

can be adjusted by: 15 mm

Thread	Dimension a	Dimension b	Dimension c	Dimension d	Dimension e-Ø	Dimension f-Ø	UNIT	PU	Contents per PU	Delivery time	Order no. 4004338...
Material: U-clip and welding nut: raw steel, connecting bolt and circlip: stainless steel											
M16	65 mm	42 mm	37 mm	30 mm	25 mm	20 mm	1	Piece	-	L	418304
M20	65 mm	42 mm	42 mm	30 mm	27 mm	25 mm	1	Piece	-	L	418311
M24	72 mm	50 mm	44 mm	35 mm	30 mm	30 mm	1	Piece	-	L	418328

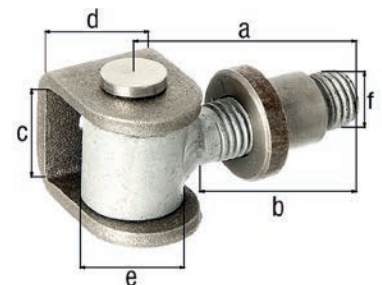

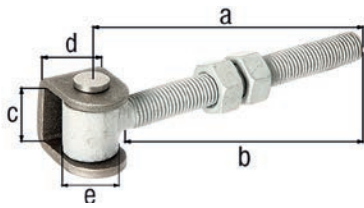

Gate hinge with U-bracket for welding and threads for screwing through

for posts up to Ø 120 mm or 120 x 120 mm

Thread	Dimension a	Dimension b	Dimension c	Dimension d	Dimension e-Ø	UNIT	PU	Contents per PU	Deliv-ery time	Order no. 4004338...
Material: U-clip: raw steel, connecting bolt and circlip: stainless steel										
M16	144 mm	138 mm	37 mm	30 mm	25 mm	1	Piece	-	L	418366
M20	153 mm	145 mm	42 mm	30 mm	25 mm	1	Piece	-	L	418373

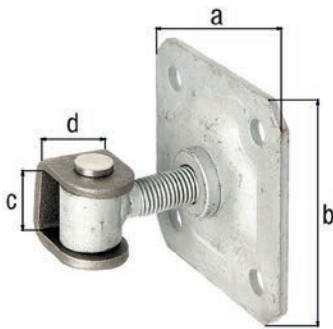

Gate hinge with U-bracket for welding and plate for screwing on

can be adjusted by: 20 mm

Thread	Dimension a	Dimension b	Dimension c	Dimension d	UNIT	PU	Contents per PU	Deliv-ery time	Order no. 4004338...
Material: U-clip: raw steel, connecting bolt and circlip: stainless steel, Surface: plate and eye screw: hot-dip galvanised									
M16	100 mm	100 mm	37 mm	30 mm	1	Piece	-	L	418397
M20	100 mm	100 mm	42 mm	30 mm	1	Piece	-	L	418403

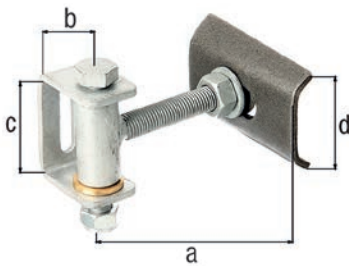

Gate hinge for 180° opening

adjustable in three levels

consists of a U-clip with elongated hole for screwing to posts, curved welding plate and one threaded rod

Thread: M16

Max. load capacity: 150 kg

Dimension a	Dimension b	Dimension c	Dimension d	UNIT	PU	Contents per PU	Deliv-ery time	Order no. 4004338...
Material: weld-on plate: raw steel, Surface: remaining parts: hot-dip galvanised								
132 mm	35 mm	70 mm	70 mm	1	Piece	-	L	411343

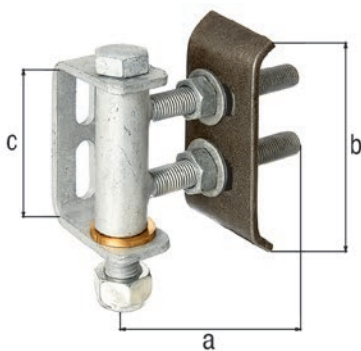

Gate hinge for 180° opening

adjustable in three levels

consists of a U-clip with two elongated holes for screwing to posts, curved welding plate and two threaded rods

Thread: M16

Max. load capacity: 300 kg

Dimension a	Dimension b	Dimension c	UNIT	PU	Contents per PU	Deliv-ery time	Order no. 4004338...
Material: weld-on plate: raw steel, Surface: remaining parts: hot-dip galvanised							
135 mm	136 mm	101 mm	1	Piece	-	L	411350

Gate hinge with plate for screwing on

adjustable in three levels

Material thickness of weld-on plate: 8.00 mm

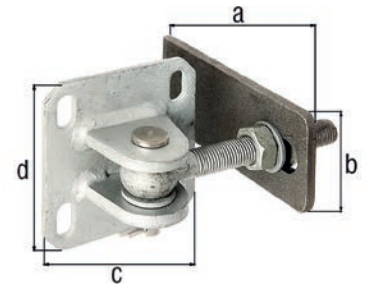

Thread	Dimension a	Dimension b	Dimension c	Dimension d	UNIT	PU	Contents per PU	Delivery time	Order no. 4004338...
Material: weld-on plate: raw steel, Surface: plate, threaded bar, screws, nuts and washers: hot-dip galvanised, for welding on									
M16	146 mm	60 mm	100 mm	100 mm	1	Piece	-	L	418649
M20	170 mm	60 mm	120 mm	120 mm	1	Piece	-	L	418656

Gate hinge for 180° opening

long version

adjustable width

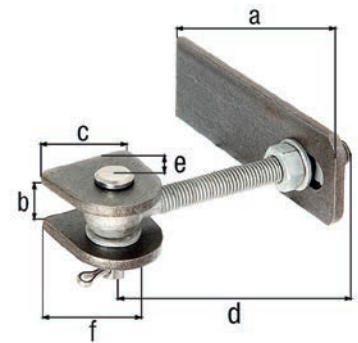

Thread	Dimension a	Dimension b	Dimension c	Dimension d	Dimension e	Dimension f	UNIT	PU	Contents per PU	Delivery time	Order no. 4004338...
Material: weld-on parts: raw steel, bolt and splint: stainless steel, Surface: screws and nuts: hot-dip galvanised											
M12	135 mm	19 mm	44 mm	120 mm	25 mm	45 mm	1	Piece	-	L	411121
M16	146 mm	23 mm	55 mm	130 mm	28 mm	50 mm	1	Piece	-	L	411138
M20	170 mm	30 mm	80 mm	150 mm	34 mm	65 mm	1	Piece	-	L	411145
M24	190 mm	33 mm	80 mm	150 mm	34 mm	65 mm	1	Piece	-	L	411152
Material: stainless steel, for welding											
M16	146 mm	23 mm	55 mm	130 mm	28 mm	50 mm	1	Piece	-	L	326203 VA
M20	170 mm	30 mm	80 mm	150 mm	34 mm	65 mm	1	Piece	-	L	326210 VA

Gate hinge for 180° opening

short version

adjustable width

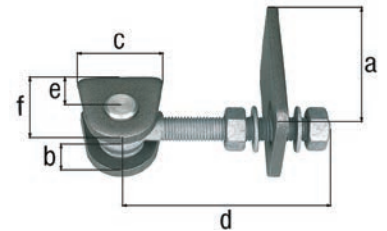

Thread	Dimension a	Dimension b	Dimension c	Dimension d	Dimension e	Dimension f	UNIT	PU	Contents per PU	Delivery time	Order no. 4004338...
Material: weld-on parts: raw steel, bolt and splint: stainless steel, Surface: screws and nuts: hot-dip galvanised											
M12	75 mm	19 mm	44 mm	120 mm	25 mm	45 mm	10	Piece	-	L	411053 GP
M16	86 mm	23 mm	55 mm	130 mm	28 mm	50 mm	8	Piece	-	L	411060 GP
M20	130 mm	30 mm	80 mm	150 mm	34 mm	65 mm	4	Piece	-	L	411077 GP
M24	145 mm	33 mm	80 mm	150 mm	34 mm	65 mm	4	Piece	-	L	411084 GP
M12	75 mm	19 mm	44 mm	120 mm	25 mm	45 mm	1	Piece	-	L	417802
M16	86 mm	23 mm	55 mm	130 mm	28 mm	50 mm	1	Piece	-	L	417819
M20	130 mm	30 mm	80 mm	150 mm	34 mm	65 mm	1	Piece	-	L	417826
M24	145 mm	33 mm	80 mm	150 mm	34 mm	65 mm	1	Piece	-	L	417833

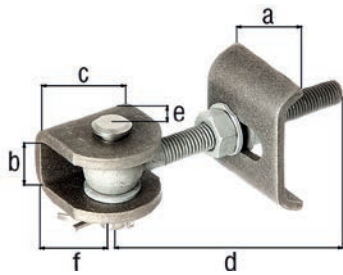

Gate hinge for 180° opening

adjustable width
frame welded-on part as U-part replaces the gusset plate

Thread	Dimension a	Dimension b	Dimension c	Dimension d	Dimension e	Dimension f	UNIT	PU	Contents per PU	Delivery time	Order no. 4004338...
Material: weld-on parts: raw steel, bolt and splint: stainless steel, Surface: screws and nuts: hot-dip galvanised											
M12	50 mm	20 mm	45 mm	120 mm	25 mm	45 mm	1	Piece	-	L	412074
M16	60 mm	27 mm	45 mm	130 mm	28 mm	50 mm	1	Piece	-	L	412173
M20	70 mm	33 mm	70 mm	150 mm	34 mm	65 mm	1	Piece	-	L	412180
M24	80 mm	36 mm	70 mm	150 mm	36 mm	65 mm	1	Piece	-	L	412197

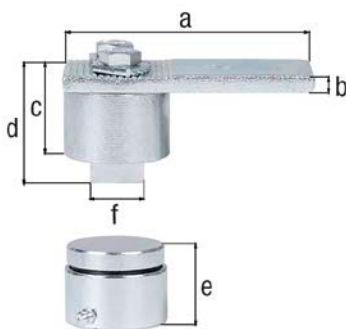

Gate hinge with tapered roller bearing

The upper support is effected by a deep groove ball bearing, the lower support is effected by a tapered roller bearing with lubricating nipple.
max. load capacity 500 kg on the lower taper roller bearing

Dimension a	Dimension b	Dimension c	Dimension d	Dimension e	Dimension f	UNIT	PU	Contents per PU	Delivery time	Order no. 4004338...
Material: raw steel, Surface: blue galvanised										
115 mm	8 mm	40.5 mm	52 mm	38 mm	25 x 25 mm	1	Piece	-	L	419462

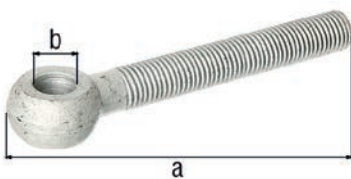

Eye screw

fits gate hinges and gate hinge brackets
fits gate hinge nos. 411121 ff.

Accessory note: Accessories not included.

Thread	Dimension a	Dimension b-Ø	UNIT	PU	Contents per PU	Delivery time	Order no. 4004338...
Material: raw steel, Surface: hot-dip galvanised							
M20	150 mm	18 mm	1	Piece	-	L	411220
M16	130 mm	16 mm	1	Piece	-	L	411213



Eye screw

fits gate hinge nos. 411121 ff.

Accessory note: Two nuts and washers included.

Thread	Dimension a	Dimension b-Ø	UNIT	PU	Contents per PU	Delivery time	Order no. 4004338...
Material: raw steel, Surface: hot-dip galvanised							
M16	130 mm	16 mm	1	Piece	-	L	417260
M20	150 mm	18 mm	1	Piece	-	L	417284

Bolts for gate hinges

fits gate hinge nos. 411121 ff.

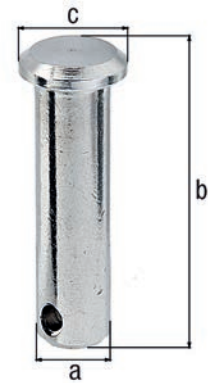

For threads	Dimension a-Ø	Dimension b	Dimension c-Ø	UNIT	PU	Contents per PU	Deliv-ery time	Order no. 4004338...	
Material: stainless steel									
M16	16 mm	57 mm	21 mm	1	Piece	-	L	417130	VA
M20	18 mm	66 mm	23 mm	1	Piece	-	L	417147	VA

Weld-on roll, two parts

Accessory note: Brass disc is delivered.

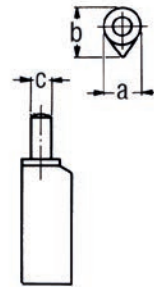

Dimension a-Ø	Dimension b	Dimension c-Ø	Dimension d	UNIT	PU	Contents per PU	Deliv-ery time	Order no. 4004338...	
Material: raw steel, for welding									
10 mm	12 mm	6 mm	60 mm	24	Piece	-	L	414856	
12 mm	14 mm	7 mm	80 mm	24	Piece	-	L	414863	
14 mm	16 mm	8 mm	100 mm	24	Piece	-	L	414870	
16 mm	18 mm	9 mm	120 mm	24	Piece	-	L	414887	
16 mm	18 mm	9 mm	140 mm	24	Piece	-	L	414894	
20 mm	23 mm	12 mm	160 mm	24	Piece	-	L	414900	
22 mm	25 mm	14 mm	180 mm	12	Piece	-	L	414917	

Weld-on roll, two parts



Dimension a-Ø	Dimension b	Dimension c	UNIT	PU	Contents per PU	Deliv-ery time	Order no. 4004338...
Material: raw steel, for welding							
16 mm	9 mm	66 mm	1	Bag	-	L	414351
18 mm	11 mm	76 mm	1	Piece	-	L	414375
20 mm	12 mm	78 mm	1	Piece	-	L	414382
22 mm	13 mm	86 mm	1	Piece	-	L	414399
25 mm	15 mm	87 mm	1	Bag	-	L	414610
27 mm	16 mm	96 mm	1	Bag	-	L	414627
30 mm	19 mm	106 mm	1	Bag	-	L	414634
35 mm	22 mm	118 mm	1	Bag	-	L	414641

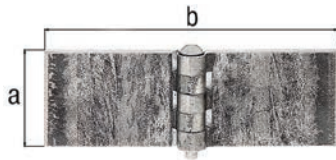

Hinge

Dimension a	Dimension b	Material thickness	UNIT	PU	Contents per PU	Deliv-ery time	Order no. 4004338...
Material: raw steel, for welding							
40 mm	120 mm	5.00 mm	10	Piece	-	L	341534
50 mm	120 mm	5.00 mm	10	Piece	-	L	341541
80 mm	160 mm	6.00 mm	10	Piece	-	L	341572

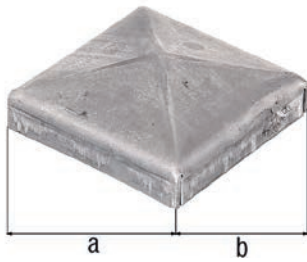

Post cap for square metal posts

Dimension a	Dimension b	UNIT	PU	Contents per PU	Deliv-ery time	Order no. 4004338...
Material: raw steel, for welding						
80 mm	80 mm	10	Piece	-	L	418021
100 mm	100 mm	10	Piece	-	L	418038
120 mm	120 mm	2	Piece	-	L	418045
150 mm	150 mm	2	Piece	-	L	418052



Jagged strip

Length: 2000 mm
 Total height: 42 mm
 Material thickness: 3.00 mm

UNIT	PU	Contents per PU	Delivery time	Order no. 4004338...
Material: raw steel, for welding				
6	Piece	-	L	410322

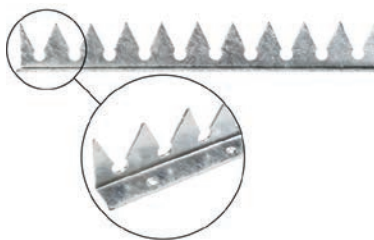

Jagged strip, angled

Length: 2000 mm
 Total height: 41 mm
 Bracket depth: 14 mm
 Height of pins: 22 mm
 Height of pins incl. curve: 29 mm
 Distance between tips: 30 mm
 Material thickness: 2.00 mm

UNIT	PU	Contents per PU	Delivery time	Order no. 4004338...
Material: raw steel, Surface: hot-dip galvanised, for screwing on				
1	Piece	-	L	410308

Handrail support, support not adjustable

for fixing to the wall

Distance between wall and middle of support: 70 mm

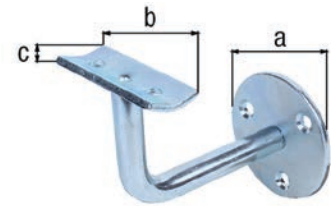

Dimension a-Ø	Dimension b	Dimension c	UNIT	PU	Contents per PU	Delivery time	Order no. 4004338...
Material: raw steel, Surface: galvanised, for screwing on, curved support							
50 mm	50 mm	20 mm	10	Piece	-	L	702472
Material: raw steel, Surface: galvanised, for screwing on, straight support							
50 mm	50 mm	20 mm	10	Piece	-	L	702489

Handrail support, support not adjustable

for fixing to the wall

Distance between wall and middle of support: 75 - 78 mm

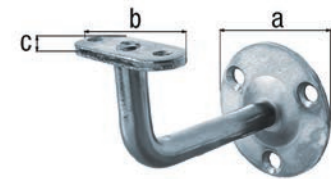

Dimension a-Ø	Dimension b	Dimension c	UNIT	PU	Contents per PU	Delivery time	Order no. 4004338...
Material: raw steel, Surface: blue galvanised							
60 mm	51 mm	21 mm	10	Piece	-	L	308995

Handrail support, support adjustable

for fixing to the wall

Distance from wall: 80 - 95 mm

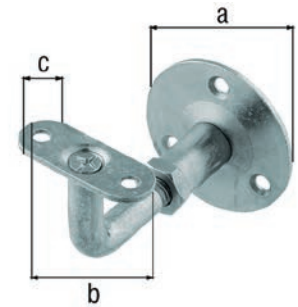

Dimension a-Ø	Dimension b	Dimension c	UNIT	PU	Contents per PU	Delivery time	Order no. 4004338...
Material: raw steel, Surface: blue galvanised, for screwing on, straight support							
60 mm	50 mm	20 mm	10	Piece	-	L	308988

Handrail support, support adjustable

for fixing to the wall

Distance between wall and middle of support: 77 mm

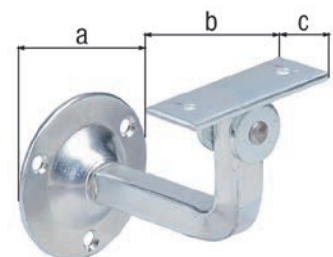

Dimension a-Ø	Dimension b	Dimension c	UNIT	PU	Contents per PU	Delivery time	Order no. 4004338...
Material: raw steel, Surface: galvanised, for screwing on, straight support							
60 mm	60 mm	23 mm	10	Piece	-	L	702496



Universal post

Length: 1020 mm
Material thickness: 2.00 mm

Dimension a	Dimension b	Dimension c	Dimension d	UNIT	PU	Contents per PU	Deliv-ery time	Order no. 4004338...
Material: raw steel, Surface: hot-dip galvanised, for screwing on								
100 mm	100 mm	30 mm	30 mm	1	Piece	-	L	700218



Universal post welded directly to the plate

for fixing to the stringer side of stairs, walls etc.

Length: 1150 mm
Material thickness: 2.00 mm

Dimension a	Dimension b	Dimension c	Dimension d	UNIT	PU	Contents per PU	Deliv-ery time	Order no. 4004338...
Material: raw steel, Surface: hot-dip galvanised, for screwing on								
100 mm	100 mm	30 mm	30 mm	1	Piece	-	L	700225



Universal post welded to the plate with 70 mm gap

for fixing to the stringer side of stairs, walls etc.

Length: 1150 mm
Material thickness: 2.00 mm

Dimension a	Dimension b	Dimension c	Dimension d	UNIT	PU	Contents per PU	Deliv-ery time	Order no. 4004338...
Material: raw steel, Surface: hot-dip galvanised, for screwing on								
100 mm	100 mm	30 mm	30 mm	1	Piece	-	L	700232

Universal post welded to the plate with 120 mm gap

for fixing to the stringer side of stairs, walls etc.

Length: 1150 mm

Material thickness: 2.00 mm



Dimension a	Dimension b	Dimension c	Dimension d	UNIT	PU	Contents per PU	Deliv-ery time	Order no. 4004338...
Material: raw steel, Surface: hot-dip galvanised, for screwing on								
100 mm	100 mm	30 mm	30 mm	1	Piece	-	L	700256

Universal post

Length: 950 mm

Material thickness: 10.00 mm

Material thickness of posts: 2.00 mm



Dimension a	Dimension b	Dimension c	Dimension d	UNIT	PU	Contents per PU	Deliv-ery time	Order no. 4004338...
Material: raw steel, Surface: hot-dip galvanised, for screwing on								
200 mm	40 mm	30 mm	30 mm	1	Piece	-	L	700300

Post cap for universal posts



Dimension a	Dimension b	UNIT	PU	Contents per PU	Deliv-ery time	Order no. 4004338...
Material: plastic, colour: black						
30 mm	30 mm	5	Card	4 Piece	L	701956

Fixing plate for universal posts

for fixing cross pieces to 30 x 30 mm posts

Leg length: 135 mm

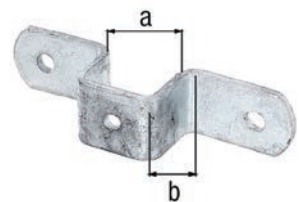

Dimension a	Dimension b	UNIT	PU	Contents per PU	Deliv-ery time	Order no. 4004338...
Material: raw steel, Surface: hot-dip galvanised						
30 mm	30 mm	10	Piece	-	L	701505

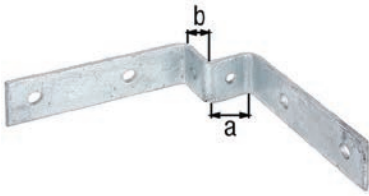

Fixing plate for universal posts

for fixing cross pieces to 30 x 30 mm corner posts

Leg length: 119 mm

Dimension a	Dimension b	UNIT	PU	Contents per PU	Deliv-ery time	Order no. 4004338...
30 mm	30 mm	10	Piece	-	L	701536

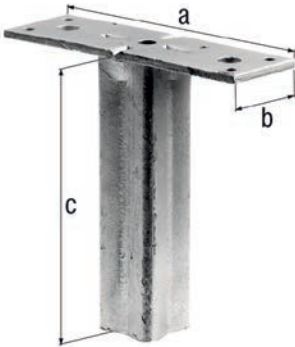

Handrail support for universal posts

for fixing handrails made of wood, aluminium etc.

For posts: 30 x 30 mm
Plate thickness: 3 mm

Dimension a	Dimension b	Dimension c	UNIT	PU	Contents per PU	Deliv-ery time	Order no. 4004338...
104 mm	30 mm	100 mm	10	Piece	-	L	701901

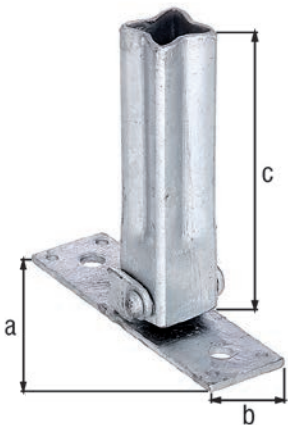

Handrail support for universal posts

for fixing handrails made of wood, aluminium etc.

adjustable from: 45 - 90 °
For posts: 30 x 30 mm
Plate thickness: 3 mm

Assembly note: The support plate is movable and adjustable from 90° to 45° in order to adapt handrails to stair angles.

Dimension a	Dimension b	Dimension c	UNIT	PU	Contents per PU	Deliv-ery time	Order no. 4004338...
104 mm	30 mm	100 mm	10	Piece	-	L	701512

WROUGHT IRON BALUSTERS

Made to last.



Starting bar

one rotation

bar extended downwards by 300 mm on one side
 cold formed
 Type: smooth
 Length: 1200 mm
 Square bar: 20 x 20 mm

Dimension a	Dimension b	UNIT	PU	Contents per PU	Deliv-ery time	Order no. 4004338...
Material: raw steel						
350 mm	290 mm	1	Piece	-	L	424282



Filling bar

one rotation

cold formed
 Type: smooth
 Length: 900 mm
 Square bar: 12 x 12 mm

Dimension a	Dimension b	UNIT	PU	Contents per PU	Deliv-ery time	Order no. 4004338...
Material: raw steel						
335 mm	230 mm	1	Piece	-	L	424367

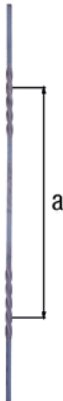

Filling bar

two rotations

cold formed
 Type: smooth
 Length: 900 mm
 Square bar: 12 x 12 mm

Dimension a	UNIT	PU	Contents per PU	Deliv-ery time	Order no. 4004338...
Material: raw steel					
450 mm	1	Piece	-	L	424442

Filling bar

one rotation

warm forged
Type: smooth
Length: 900 mm
Square bar: 12 x 12 mm

Dimension a	Dimension b	UNIT	PU	Contents per PU	Deliv-ery time	Order no. 4004338...
Material: raw steel						
335 mm	230 mm	1	Piece	-	L	420604



Decorative bar

two rotations

with C embellishment
warm forged
Type: smooth
Length: 900 mm
Square bar: 12 x 12 mm

Dimension a	Dimension b	Dimension c	Dimension d	UNIT	PU	Contents per PU	Deliv-ery time	Order no. 4004338...
Material: raw steel								
450 mm	130 mm	110 mm	132 mm	1	Piece	-	L	420727

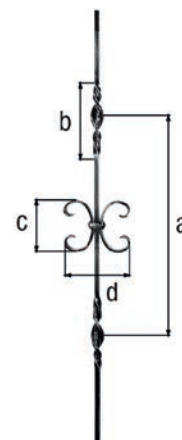

Decorative bar

one rotation

with C embellishment
warm forged
Type: smooth
Length: 900 mm
Square bar: 12 x 12 mm

Dimension a	Dimension b	Dimension c	Dimension d	UNIT	PU	Contents per PU	Deliv-ery time	Order no. 4004338...
Material: raw steel								
450 mm	230 mm	110 mm	132 mm	1	Piece	-	L	420765

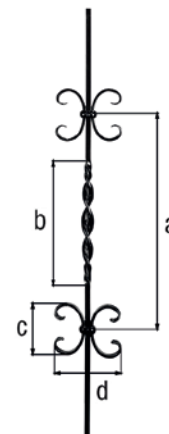

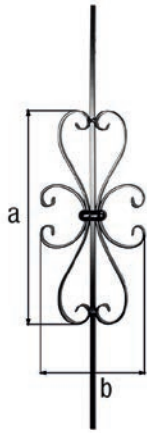

Decorative bar

with ornament
 Type: smooth
 Length: 900 mm
 Square bar: 12 x 12 mm

Dimension a	Dimension b	UNIT	PU	Contents per PU	Deliv-ery time	Order no. 4004338...
Material: raw steel						
450 mm	225 mm	1	Piece	-	L	420680

Embellishment, type C

ends warm forged

Dimension a	Dimension b	Square bar	UNIT	PU	Contents per PU	Delivery time	Order no. 4004338...
Material: raw steel							
40 mm	93 mm	10 x 4 mm	20	Piece	-	L	421960
60 mm	110 mm	12 x 6 mm	20	Piece	-	L	422202
85 mm	150 mm	12 x 5 mm	10	Piece	-	L	421885

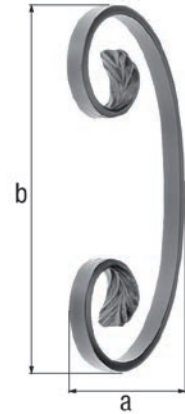

Embellishment, type S

ends warm forged
Square bar: 12 x 5 mm

Dimension a	Dimension b	UNIT	PU	Contents per PU	Delivery time	Order no. 4004338...
Material: raw steel						
72 mm	155 mm	10	Piece	-	L	422042

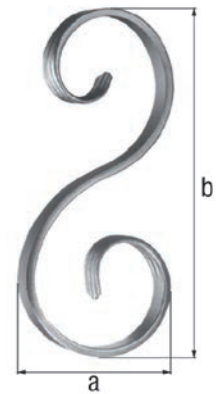

Embellishment, type S

ends warm forged
Square bar: 12 x 6 mm

Dimension a	Dimension b	UNIT	PU	Contents per PU	Delivery time	Order no. 4004338...
Material: raw steel						
110 mm	270 mm	10	Piece	-	L	422240

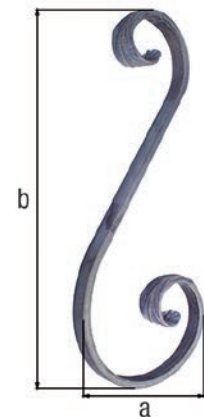

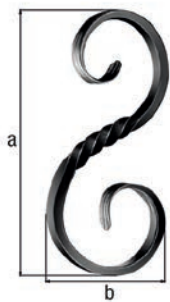

Embellishment, type S

cold formed
ends warm forged
Square bar: 8 x 8 mm

Dimension a	Dimension b	UNIT	PU	Contents per PU	Deliv-ery time	Order no.
Material: raw steel						
125 mm	250 mm	10	Piece	-	L	421489

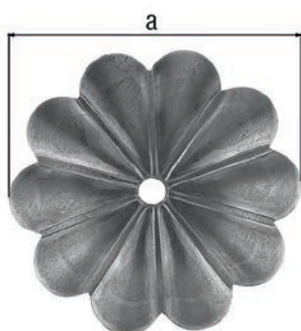

Decorative rosette

Material thickness: 5.00 mm

Dimension a	UNIT	PU	Contents per PU	Deliv-ery time	Order no.
Material: raw steel					
92 mm	10	Piece	-	L	423322

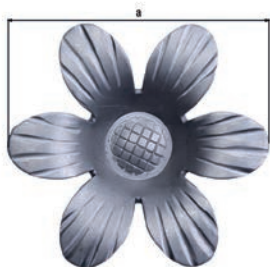

Decorative rosette

Material thickness: 2.50 mm

Dimension a	UNIT	PU	Contents per PU	Deliv-ery time	Order no.
Material: raw steel					
90 mm	10	Piece	-	L	422684



Decorative element leaf

Material thickness: 2.50 mm

Dimension a	UNIT	PU	Contents per PU	Deliv-ery time	Order no.
Material: raw steel					
87 mm	10	Piece	-	L	422646

Cover rosette

Type: hammered

Dimension a	Dimension b	UNIT	PU	Contents per PU	Delivery time	Order no. 4004338...
Material: raw steel						
50 mm	12 mm	10	Piece	-	L	422882
70 mm	20 mm	10	Piece	-	L	422929

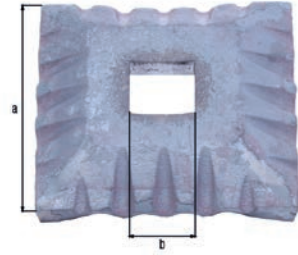

Collar for connecting decorative elements

for two 12 x 6 mm decorative elements

Dimension a	Dimension b	Dimension c	Dimension d	UNIT	PU	Contents per PU	Delivery time	Order no. 4004338...
Material: raw steel								
25 mm	23 mm	16 mm	5 mm	5	Card	10 Piece	L	422578

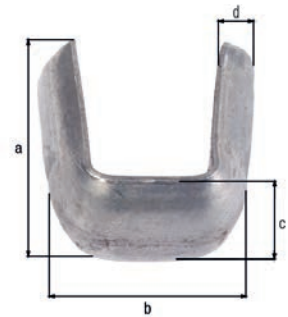

Collar for connecting decorative elements

for one 12 x 12 mm bar and two 12 x 6 mm decorative elements

Dimension a	Dimension b	Dimension c	Dimension d	UNIT	PU	Contents per PU	Delivery time	Order no. 4004338...
Material: raw steel								
32 mm	35 mm	16 mm	5 mm	5	Card	10 Piece	L	422615

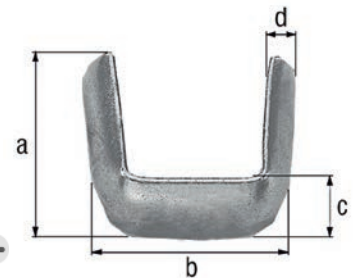

Decorative element final

warm forged
Lug-Ø: 12 mm

Dimension a	Dimension b	Lug-Ø	UNIT	PU	Contents per PU	Delivery time	Order no. 4004338...
Material: raw steel							
60 mm	132 mm	12 mm	1	Bag	-	L	441166

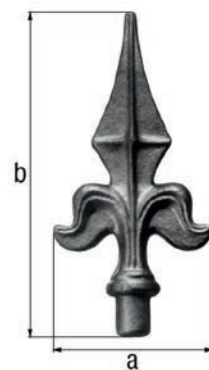



Handrail profile, wrought iron

Type: hammered

Length	Dimension a	Dimension b	UNIT	PU	Contents per PU	Deliv-ery time	Order no. 4004338...
Material: raw steel							
2000 mm	40 mm	8 mm	1	Piece	-	L	424664

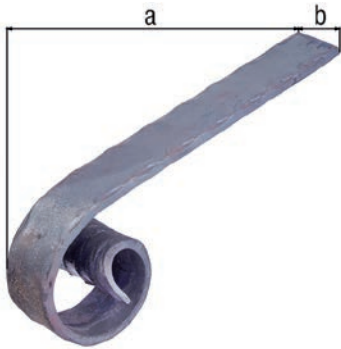

Handrail start, short form

wrought iron

Type: hammered
Flat iron: 40 x 8 mm

Dimension a	Dimension b	UNIT	PU	Contents per PU	Deliv-ery time	Order no. 4004338...
Material: raw steel						
300 mm	40 mm	1	Piece	-	L	423681



Handrail curve, wrought iron

Type: hammered
Material thickness: 8.00 mm
Radius: 150 mm

Dimension a	Dimension b	Dimension c	UNIT	PU	Contents per PU	Deliv-ery time	Order no. 4004338...
Material: raw steel							
40 mm	400 mm	400 mm	1	Piece	-	L	423087

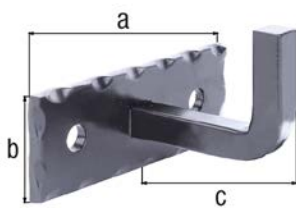

Handrail support

for fixing to the wall

Type: hammered
Handrail connection: 12 x 12 mm
Plate thickness: 5 mm

Dimension a	Dimension b	Dimension c	UNIT	PU	Contents per PU	Deliv-ery time	Order no. 4004338...
Material: raw steel, Surface: galvanised, black-coloured, for screwing on							
110 mm	40 mm	78 mm	5	Piece	-	L	423001



Handrail, wrought iron in standard lengths

welded-on handrail supports

the ends are warm forged on both sides

Type: hammered

Distance from middle to middle of holes: 68 mm

Distance from wall: 50 mm

Flat iron: 40 x 8 mm

Plate Ø: 90 mm

Length	No. of supports	UNIT	PU	Contents per PU	Deliv-ery time	Order no. 4004338...
Material: raw steel, Surface: hot-dip galvanised						
800 mm	2	1	Piece	-	L	440022
1000 mm	2	1	Piece	-	L	440039
2000 mm	3	1	Piece	-	L	440060

WROUGHT IRON WINDOW GRILLES

Made to last.

Window grille Basic I in customised dimensions

for mounting in the window reveal or on the outside wall

customised production on request

please indicate the reveal width and the reveal height as dimensions

Note on filler material: Square bar

Filler material Ø: 12 mm



Assembly note: When mounting the window grille to the wall, the window grille must be wide enough so that the fixing drill holes are at least 80 mm from the window reveal. Otherwise the masonry may break.

Accessory note: Please order the fastening and screw sets separately.

Clear width	Height	Frame width	Frame height	Frame thickness	Number of attachment points	Traverse	UNIT	PU	Contents per PU	Deliv-ery time	Order no. 4004338...	
Material: raw steel, Surface: hot-dip galvanised passivated, mounting on the wall												
320 - 570 mm	400 - 800 mm	400 - 650 mm	400 - 800 mm	20 x 20 mm	4	without	1	Piece	-	S	564209	15
571 - 945 mm	400 - 800 mm	651 - 1025 mm	400 - 800 mm	20 x 20 mm	4	without	1	Piece	-	S	564216	15
946 - 1320 mm	400 - 800 mm	1026 - 1400 mm	400 - 800 mm	20 x 20 mm	4	without	1	Piece	-	S	564223	15
1321 - 1820 mm	400 - 800 mm	1401 - 1900 mm	400 - 800 mm	20 x 20 mm	4	without	1	Piece	-	S	564230	15
320 - 570 mm	801 - 1400 mm	400 - 650 mm	801 - 1400 mm	20 x 20 mm	4	without	1	Piece	-	S	564247	15
571 - 945 mm	801 - 1400 mm	651 - 1025 mm	801 - 1400 mm	20 x 20 mm	4	without	1	Piece	-	S	564254	15
946 - 1320 mm	801 - 1400 mm	1026 - 1400 mm	801 - 1400 mm	20 x 20 mm	4	without	1	Piece	-	S	564261	15
1321 - 1820 mm	801 - 1400 mm	1401 - 1900 mm	801 - 1400 mm	20 x 20 mm	4	without	1	Piece	-	S	564278	15
320 - 570 mm	1401 - 2000 mm	400 - 650 mm	1401 - 2000 mm	30 x 20 mm	8	with	1	Piece	-	S	564285	15
571 - 945 mm	1401 - 2000 mm	651 - 1025 mm	1401 - 2000 mm	30 x 20 mm	8	with	1	Piece	-	S	564292	15
946 - 1320 mm	1401 - 2000 mm	1026 - 1400 mm	1401 - 2000 mm	30 x 20 mm	8	with	1	Piece	-	S	564308	15
1321 - 1820 mm	1401 - 2000 mm	1401 - 1900 mm	1401 - 2000 mm	30 x 20 mm	8	with	1	Piece	-	S	564315	15
Material: raw steel, Surface: hot-dip galvanised passivated, fixing in the reveal												
440 - 690 mm	440 - 840 mm	400 - 650 mm	400 - 800 mm	20 x 20 mm	4	without	1	Piece	-	S	564612	15
691 - 1065 mm	440 - 840 mm	651 - 1025 mm	400 - 800 mm	20 x 20 mm	4	without	1	Piece	-	S	564629	15
1066 - 1440 mm	440 - 840 mm	1026 - 1400 mm	400 - 800 mm	20 x 20 mm	4	without	1	Piece	-	S	564636	15
1441 - 1940 mm	440 - 840 mm	1401 - 1900 mm	400 - 800 mm	20 x 20 mm	4	without	1	Piece	-	S	564643	15
440 - 690 mm	841 - 1440 mm	400 - 650 mm	801 - 1400 mm	20 x 20 mm	4	without	1	Piece	-	S	564650	15
691 - 1065 mm	841 - 1440 mm	651 - 1025 mm	801 - 1400 mm	20 x 20 mm	4	without	1	Piece	-	S	564667	15
1066 - 1440 mm	841 - 1440 mm	1026 - 1400 mm	801 - 1400 mm	20 x 20 mm	4	without	1	Piece	-	S	564674	15
1441 - 1940 mm	841 - 1440 mm	1401 - 1900 mm	801 - 1400 mm	20 x 20 mm	4	without	1	Piece	-	S	564681	15
440 - 690 mm	1441 - 2040 mm	400 - 650 mm	1401 - 2000 mm	30 x 20 mm	8	with	1	Piece	-	S	564698	15
691 - 1065 mm	1441 - 2040 mm	651 - 1025 mm	1401 - 2000 mm	30 x 20 mm	8	with	1	Piece	-	S	564704	15
1066 - 1440 mm	1441 - 2040 mm	1026 - 1400 mm	1401 - 2000 mm	30 x 20 mm	8	with	1	Piece	-	S	564711	15
1441 - 1940 mm	1441 - 2040 mm	1401 - 1900 mm	1401 - 2000 mm	30 x 20 mm	8	with	1	Piece	-	S	564728	15



Window grille Basic II in customised dimensions

for mounting in the window reveal or on the outside wall

customised production on request

please indicate the reveal width and the reveal height as dimensions

Note on filler material: Square bar

Filler material Ø: 12 mm

Assembly note: When mounting the window grille to the wall, the window grille must be wide enough so that the fixing drill holes are at least 80 mm from the window reveal. Otherwise the masonry may break.

Accessory note: Please order the fastening and screw sets separately.

	Clear width	Height	Frame width	Frame height	Frame thickness	Number of attachment points	Traverse	UNIT	PU	Contents per PU	Deliv-ery time	Order no. 4004338...
Material: raw steel, Surface: hot-dip galvanised passivated, mounting on the wall												
15	320 - 570 mm	400 - 800 mm	400 - 650 mm	400 - 800 mm	20 x 20 mm	4	without	1	Piece	-	S	564322
15	571 - 945 mm	400 - 800 mm	651 - 1025 mm	400 - 800 mm	20 x 20 mm	4	without	1	Piece	-	S	564339
15	946 - 1320 mm	400 - 800 mm	1026 - 1400 mm	400 - 800 mm	20 x 20 mm	4	without	1	Piece	-	S	564346
15	1321 - 1820 mm	400 - 800 mm	1401 - 1900 mm	400 - 800 mm	20 x 20 mm	4	without	1	Piece	-	S	564353
15	320 - 570 mm	801 - 1400 mm	400 - 650 mm	801 - 1400 mm	20 x 20 mm	4	without	1	Piece	-	S	564360
15	571 - 945 mm	801 - 1400 mm	651 - 1025 mm	801 - 1400 mm	20 x 20 mm	4	without	1	Piece	-	S	564377
15	946 - 1320 mm	801 - 1400 mm	1026 - 1400 mm	801 - 1400 mm	20 x 20 mm	4	without	1	Piece	-	S	564384
15	1321 - 1820 mm	801 - 1400 mm	1401 - 1900 mm	801 - 1400 mm	20 x 20 mm	4	without	1	Piece	-	S	564391
15	320 - 570 mm	1401 - 2000 mm	400 - 650 mm	1401 - 2000 mm	30 x 20 mm	8	with	1	Piece	-	S	564407
15	571 - 945 mm	1401 - 2000 mm	651 - 1025 mm	1401 - 2000 mm	30 x 20 mm	8	with	1	Piece	-	S	564414
15	946 - 1320 mm	1401 - 2000 mm	1026 - 1400 mm	1401 - 2000 mm	30 x 20 mm	8	with	1	Piece	-	S	564421
15	1321 - 1820 mm	1401 - 2000 mm	1401 - 1900 mm	1401 - 2000 mm	30 x 20 mm	8	with	1	Piece	-	S	564438
Material: raw steel, Surface: hot-dip galvanised passivated, fixing in the reveal												
15	440 - 690 mm	440 - 840 mm	400 - 650 mm	400 - 800 mm	20 x 20 mm	4	without	1	Piece	-	S	564735
15	691 - 1065 mm	440 - 840 mm	651 - 1025 mm	400 - 800 mm	20 x 20 mm	4	without	1	Piece	-	S	564742
15	1066 - 1440 mm	440 - 840 mm	1026 - 1400 mm	400 - 800 mm	20 x 20 mm	4	without	1	Piece	-	S	564759
15	1441 - 1940 mm	440 - 840 mm	1401 - 1900 mm	400 - 800 mm	20 x 20 mm	4	without	1	Piece	-	S	564766
15	440 - 690 mm	841 - 1440 mm	400 - 650 mm	801 - 1400 mm	20 x 20 mm	4	without	1	Piece	-	S	564773
15	691 - 1065 mm	841 - 1440 mm	651 - 1025 mm	801 - 1400 mm	20 x 20 mm	4	without	1	Piece	-	S	564780
15	1066 - 1440 mm	841 - 1440 mm	1026 - 1400 mm	801 - 1400 mm	20 x 20 mm	4	without	1	Piece	-	S	564797
15	1441 - 1940 mm	841 - 1440 mm	1401 - 1900 mm	801 - 1400 mm	20 x 20 mm	4	without	1	Piece	-	S	564803
15	440 - 690 mm	1441 - 2040 mm	400 - 650 mm	1401 - 2000 mm	30 x 20 mm	8	with	1	Piece	-	S	564810
15	691 - 1065 mm	1441 - 2040 mm	651 - 1025 mm	1401 - 2000 mm	30 x 20 mm	8	with	1	Piece	-	S	564827
15	1066 - 1440 mm	1441 - 2040 mm	1026 - 1400 mm	1401 - 2000 mm	30 x 20 mm	8	with	1	Piece	-	S	564834
15	1441 - 1940 mm	1441 - 2040 mm	1401 - 1900 mm	1401 - 2000 mm	30 x 20 mm	8	with	1	Piece	-	S	564841

Window grille Frankfurt in customised dimensions

for mounting in the window reveal or on the outside wall

customised production on request
 please indicate the reveal width and the reveal height as dimensions
 Note on filler material: Square bar
 Frame thickness: 30 x 20 mm
 Filler material Ø: 16 mm
 Number of attachment points: 4
 Traverse: without

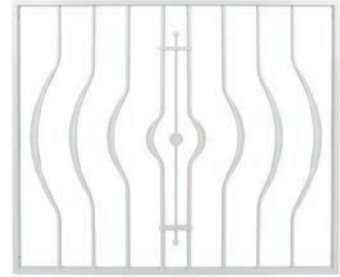

Assembly note: When mounting the window grille to the wall, the window grille must be wide enough so that the fixing drill holes are at least 80 mm from the window reveal. Otherwise the masonry may break.

Accessory note: Please order the fastening and screw sets separately.

Clear width	Height	Frame width	Frame height	UNIT	PU	Contents per PU	Deliv-ery time	Order no. 4004338...	
Material: raw steel, Surface: hot-dip galvanised passivated, mounting on the wall									
320 - 570 mm	880 - 1160 mm	400 - 650 mm	880 - 1160 mm	1	Piece	-	S	564445	15
571 - 945 mm	880 - 1160 mm	651 - 1025 mm	880 - 1160 mm	1	Piece	-	S	564452	15
946 - 1170 mm	880 - 1160 mm	1026 - 1250 mm	880 - 1160 mm	1	Piece	-	S	564469	15
Material: raw steel, Surface: hot-dip galvanised passivated, fixing in the reveal									
440 - 690 mm	920 - 1200 mm	400 - 650 mm	880 - 1160 mm	1	Piece	-	S	564858	15
691 - 1065 mm	920 - 1200 mm	651 - 1025 mm	880 - 1160 mm	1	Piece	-	S	564865	15
1066 - 1290 mm	920 - 1200 mm	1026 - 1250 mm	880 - 1160 mm	1	Piece	-	S	564872	15

Window grille Hamburg in customised dimensions

for mounting in the window reveal or on the outside wall

customised production on request
 please indicate the reveal width and the reveal height as dimensions
 Note on filler material: Square bar
 Frame thickness: 20 x 20 mm
 Filler material Ø: 12 mm
 Number of attachment points: 4
 Traverse: without



Assembly note: When mounting the window grille to the wall, the window grille must be wide enough so that the fixing drill holes are at least 80 mm from the window reveal. Otherwise the masonry may break.

Accessory note: Please order the fastening and screw sets separately.

Clear width	Height	Frame width	Frame height	UNIT	PU	Contents per PU	Deliv-ery time	Order no. 4004338...	
Material: raw steel, Surface: hot-dip galvanised passivated, mounting on the wall									
320 - 570 mm	400 - 600 mm	400 - 650 mm	400 - 600 mm	1	Piece	-	S	564476	15
571 - 945 mm	400 - 600 mm	651 - 1025 mm	400 - 600 mm	1	Piece	-	S	564483	15
946 - 1195 mm	400 - 600 mm	1026 - 1275 mm	400 - 600 mm	1	Piece	-	S	564490	15
320 - 570 mm	601 - 1000 mm	400 - 650 mm	601 - 1000 mm	1	Piece	-	S	564506	15
571 - 945 mm	601 - 1000 mm	651 - 1025 mm	601 - 1000 mm	1	Piece	-	S	564513	15
946 - 1195 mm	601 - 1000 mm	1026 - 1275 mm	601 - 1000 mm	1	Piece	-	S	564520	15
Material: raw steel, Surface: hot-dip galvanised passivated, fixing in the reveal									
440 - 690 mm	440 - 640 mm	400 - 650 mm	400 - 600 mm	1	Piece	-	S	564889	15
691 - 1065 mm	440 - 640 mm	651 - 1025 mm	400 - 600 mm	1	Piece	-	S	564896	15
1066 - 1315 mm	440 - 640 mm	1026 - 1275 mm	400 - 600 mm	1	Piece	-	S	564902	15
440 - 690 mm	641 - 1040 mm	400 - 650 mm	601 - 1000 mm	1	Piece	-	S	564919	15
691 - 1065 mm	641 - 1040 mm	651 - 1025 mm	601 - 1000 mm	1	Piece	-	S	564926	15
1066 - 1315 mm	641 - 1040 mm	1026 - 1275 mm	601 - 1000 mm	1	Piece	-	S	564933	15

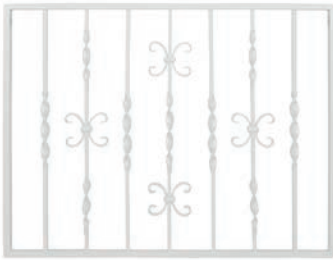

Window grille München in customised dimensions

for mounting in the window reveal or on the outside wall

customised production on request
 please indicate the reveal width and the reveal height as dimensions
 Note on filler material: Square bar
 Frame height: 690 - 925 mm
 Frame thickness: 20 x 20 mm
 Filler material: 12 x 12 mm
 Number of attachment points: 4
 Traverse: without

Assembly note: When mounting the window grille to the wall, the window grille must be wide enough so that the fixing drill holes are at least 80 mm from the window reveal. Otherwise the masonry may break.

Accessory note: Please order the fastening and screw sets separately.

	Clear width	Height	Frame width	Frame height	UNIT	PU	Contents per PU	Deliv-ery time	Order no. 4004338...
Material: raw steel, Surface: hot-dip galvanised passivated, mounting on the wall									
15	320 - 570 mm	690 - 925 mm	400 - 650 mm	690 - 925 mm	1	Piece	-	S	564537
15	571 - 945 mm	690 - 925 mm	651 - 1025 mm	690 - 925 mm	1	Piece	-	S	564544
15	946 - 1195 mm	690 - 925 mm	1026 - 1275 mm	690 - 925 mm	1	Piece	-	S	564551
15	1196 - 1445 mm	690 - 925 mm	1276 - 1525 mm	690 - 925 mm	1	Piece	-	S	564568
Material: raw steel, Surface: hot-dip galvanised passivated, fixing in the reveal									
15	440 - 690 mm	730 - 965 mm	400 - 650 mm	690 - 925 mm	1	Piece	-	S	564940
15	691 - 1065 mm	730 - 965 mm	651 - 1025 mm	690 - 925 mm	1	Piece	-	S	564957
15	1066 - 1315 mm	730 - 965 mm	1026 - 1275 mm	690 - 925 mm	1	Piece	-	S	564964
15	1316 - 1565 mm	730 - 965 mm	1276 - 1525 mm	690 - 925 mm	1	Piece	-	S	564971

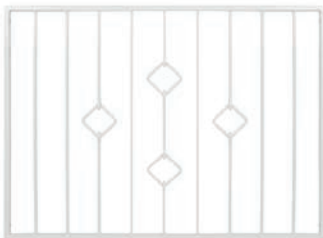

Window grille Köln in customised dimensions

for mounting in the window reveal or on the outside wall

customised production on request
 please indicate the reveal width and the reveal height as dimensions
 Note on filler material: Square bar
 Frame height: 610 - 1000 mm
 Frame thickness: 20 x 20 mm
 Filler material Ø: 12 mm
 Number of attachment points: 4
 Traverse: without

Assembly note: When mounting the window grille to the wall, the window grille must be wide enough so that the fixing drill holes are at least 80 mm from the window reveal. Otherwise the masonry may break.

Accessory note: Please order the fastening and screw sets separately.

	Clear width	Height	Frame width	Frame height	UNIT	PU	Contents per PU	Deliv-ery time	Order no. 4004338...
Material: raw steel, Surface: hot-dip galvanised passivated, mounting on the wall									
15	320 - 570 mm	610 - 1000 mm	400 - 650 mm	610 - 1000 mm	1	Piece	-	S	564575
15	571 - 945 mm	610 - 1000 mm	651 - 1025 mm	610 - 1000 mm	1	Piece	-	S	564582
15	946 - 1195 mm	610 - 1000 mm	1026 - 1275 mm	610 - 1000 mm	1	Piece	-	S	564599
15	1196 - 1445 mm	610 - 1000 mm	1276 - 1525 mm	610 - 1000 mm	1	Piece	-	S	564605
Material: raw steel, Surface: hot-dip galvanised passivated, fixing in the reveal									
15	440 - 690 mm	650 - 1040 mm	400 - 650 mm	610 - 1000 mm	1	Piece	-	S	564988
15	691 - 1065 mm	650 - 1040 mm	651 - 1025 mm	610 - 1000 mm	1	Piece	-	S	564995
15	1066 - 1315 mm	650 - 1040 mm	1026 - 1275 mm	610 - 1000 mm	1	Piece	-	S	565008
15	1316 - 1565 mm	650 - 1040 mm	1276 - 1525 mm	610 - 1000 mm	1	Piece	-	S	565015

Window grille Salzburg, can be shortened individually

Square bar: 12 x 12 mm

Assembly note: We recommend assembly in the window reveal (with fastening set: 554361). The bars can be shortened to fit the reveal exactly.

Accessory note: Fixing sets not included. They can be ordered separately.

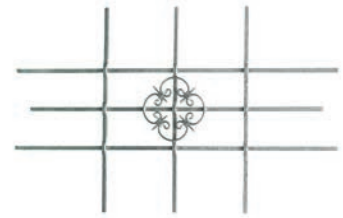

Min. width	Max. width	min. height	max. height	UNIT	PU	Contents per PU	Deliv-ery time	Order no. 4004338...	
Material: raw steel, Surface: hot-dip galvanised									
590 mm	1140 mm	390 mm	690 mm	1	Piece	-	L	553548	15
1090 mm	1680 mm	510 mm	840 mm	1	Piece	-	L	553555	15

Window grille Friedberg

for mounting on the outside wall

Length of plate: 60 mm

Total width: 940 mm

Total height: 740 mm

Traverse: 30 x 4 mm

Offset: 30 mm

• Stable solid material

Accessory note: screws not included



UNIT	PU	Contents per PU	Delivery time	Order no. 4004338...	
Material: raw steel, Surface: hot-dip galvanised, mounting on the wall					
1	Piece	-	L	558802	15
Material: raw steel, Surface: hot-dip galvanised, white powder-coated, mounting on the wall					
1	Piece	-	S	558819	15
Material: raw steel, Surface: hot-dip galvanised, powder-coated anthracite-metallic, mounting on the wall					
1	Piece	-	S	558826	15

Fixing set for window grilles, fixing in the window reveal

Mounting: 12 x 12 mm



Set components: One set consists of four holders (for square 12 x 12 mm), four safety screws 7x50 and four dowels M10

UNIT	PU	Contents per PU	Delivery time	Order no. 4004338...	
Material: raw steel, Surface: blue galvanised					
15	1	Pack	4 Set	L	554361

Fixing set for window grilles, fixing on the wall

Mounting: 12 x 12 mm



Assembly note: When mounting the window grille to the wall, the window grille must be wide enough so that the fixing drill holes are at least 80 mm from the window reveal. Otherwise the masonry may break.

Set components: One set consists of four holders (for square 12 x 12 mm), four safety screws 7x50 and four dowels M10

UNIT	PU	Contents per PU	Delivery time	Order no. 4004338...	
Material: raw steel, Surface: blue galvanised					
15	1	Pack	4 Set	L	554378

Screw set, for the fixation of window grilles

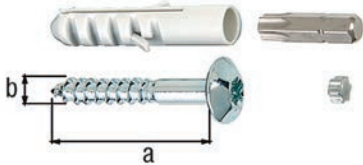

Set components: One set consists of four safety screws 7 x 50 mm or 7 x 105 mm and four dowels M10

Dimension a	Dimension b	UNIT	PU	Contents per PU	Deliv- ery time	Order no. 4004338...	
Material: raw steel, Surface: galvanised							
15	50 mm	7 mm	1	Pack	4 Piece	L	554385
15	105 mm	7 mm	1	Pack	4 Piece	L	554415

Spacer sleeve for screws

For Ø: 5 - 8 mm

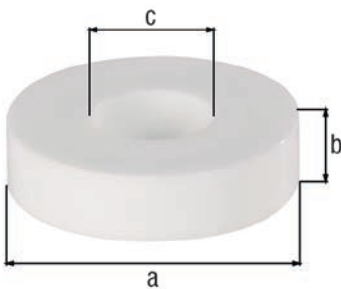

Dimension a-Ø	Dimension b	Dimension c-Ø	UNIT	PU	Contents per PU	Deliv- ery time	Order no. 4004338...
Material: plastic (polystyrene), colour: white							
20 mm	5 mm	8.5 mm	4	Pack	20 Piece	L	338657
20 mm	10 mm	8.5 mm	4	Pack	15 Piece	L	338671
20 mm	20 mm	8.5 mm	4	Pack	10 Piece	L	338695

Spacer sleeve set for screws

For Ø: 5 - 8 mm

Set components: One set consists of five pieces for each height

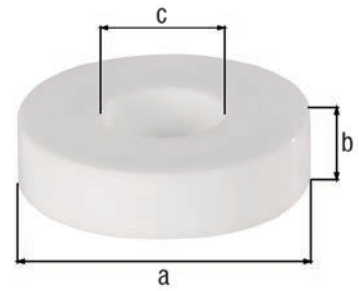

Dimension a-Ø	Dimension b	Dimension c-Ø	UNIT	PU	Contents per PU	Deliv-ery time	Order no. 4004338...
Material: plastic (polystyrene), colour: black							
20 mm	5 / 10 / 20 / 30 mm	8.5 mm	4	Pack	5 Piece	L	338725
Material: plastic (polystyrene), colour: white							
20 mm	5 / 10 / 20 / 30 mm	8.5 mm	4	Pack	5 Piece	L	338718

Screw set, for the fixation window grilles on facades

Set components: One bag consists of four anchor rods Ø10 mm, galvanised for insulation thickness 80 - 100 mm, four plugs 12 x 60 mm, four safety screws M10 x 20 mm, galvanised, four washers, galvanised and a bit



UNIT	PU	Contents per PU	Delivery time	Order no. 4004338...
Material: raw steel, Surface: galvanised				
1	Bag	4 Set	L	557768

Fixing set for window grilles

suitable for customised window grilles type Basic I and II as well as type Frankfurt, Hamburg, München and Köln

Accessory note: The delivery consists of fitting bolts for fixing the plates to the window grilles. Safety screws for mounting on the wall are not included in delivery, but can be ordered separately.

Set components: One set consists of four plates, four spacer sleeves and four screws



UNIT	PU	Contents per PU	Delivery time	Order no. 4004338...
Material: raw steel, Surface: hot-dip galvanised				
1	Bag	4 Set	L	557751
Material: raw steel, Surface: hot-dip galvanised, black matt powder-coated RAL 9005				
1	Bag	4 Set	L	557775
Material: raw steel, Surface: hot-dip galvanised, white powder-coated RAL 9010				
1	Bag	4 Set	L	557782



Window grille Amsterdam, for fixing in window reveal

extending grille with decorative elements

double-guided transverse bars
 Width of attachment plate: 35 mm
 Width of vertical bars: 35 mm

Assembly note: These window grilles are individually adjustable to any width. For long-lasting corrosion protection, it is essential to treat the window grilles with wrought iron paint after purchase. You can find a suitable setup video at www.youtube.com/@alberts1852

Accessory note: Four safety screws and plugs included.

	Min. width	Max. width	Total height	Number of traverses	UNIT	PU	Contents per PU	Deliv-ery time	Order no. 4004338...
Material: raw steel, Surface: blue galvanised									
15	500 mm	650 mm	300 mm	2	1	Piece	-	L	553586
15	700 mm	1050 mm	300 mm	2	1	Piece	-	L	553593
15	1000 mm	1500 mm	300 mm	2	1	Piece	-	L	553609
15	500 mm	650 mm	450 mm	3	1	Piece	-	L	553616
15	700 mm	1050 mm	450 mm	3	1	Piece	-	L	553623
15	1000 mm	1500 mm	450 mm	3	1	Piece	-	L	553630
15	500 mm	650 mm	600 mm	4	1	Piece	-	L	553647
15	700 mm	1050 mm	600 mm	4	1	Piece	-	L	553654
15	1000 mm	1500 mm	600 mm	4	1	Piece	-	L	553661



Window grille Venlo, for fixing in window reveal

extending grille without decorative elements

double-guided transverse bars
 Width of attachment plate: 35 mm
 Width of vertical bars: 35 mm

Assembly note: These window grilles are individually adjustable to any width. For long-lasting corrosion protection, it is essential to treat the window grilles with wrought iron paint after purchase. You can find a suitable setup video at www.youtube.com/@alberts1852

Accessory note: Four safety screws and plugs included.

	Min. width	Max. width	Total height	Number of traverses	UNIT	PU	Contents per PU	Deliv-ery time	Order no. 4004338...
Material: raw steel, Surface: blue galvanised									
15	500 mm	650 mm	300 mm	2	1	Piece	-	L	553678
15	700 mm	1050 mm	300 mm	2	1	Piece	-	L	553685
15	500 mm	650 mm	450 mm	3	1	Piece	-	L	553692
15	700 mm	1050 mm	450 mm	3	1	Piece	-	L	553708

Fixing set for extending window grilles in the interior for folding out

suitable for Amsterdam and Venlo extending grilles

- Ideal for cellar windows
- The external house wall is not affected (exterior rendering, insulation, etc.), because the window grille is installed inside the house before the window.
- Before opening or cleaning the cellar window, remove the shackle lock and fold the window grille down.

Assembly note: You can find a suitable setup video at www.youtube.com/@alberts1852

Accessory note: Delivery includes the shackle lock.
Screws for wall mounting are included with the extending grille.



UNIT	PU	Contents per PU	Delivery time	Order no. 4004338...
Material: raw steel, Surface: white powder-coated				
1	Bag	1 Set	L	557171



Grating securing device

with countersunk screw holes

stainless steel threaded pin and wing nut
with two hot dip galvanised cover plates covering the grid
Length: 370 mm
Flat iron: 19 x 2.5 mm

- High degree of safety due to broad contact surface.

Accessory note: Fasteners included.

UNIT	PU	Contents per PU	Delivery time	Order no. 4004338...
Material: raw steel, Surface: galvanised				
3	Card	2 Piece	L	901646



Grating securing device

Length: 300 mm
Flat iron: 20 x 2.8 mm

Accessory note: Ring bolt and plugs included.

UNIT	PU	Contents per PU	Delivery time	Order no. 4004338...
Material: raw steel, Surface: galvanised				
5	Card	2 Piece	L	901622

PROFILE BOARD CLAWS AND ACCESSORIES

Made to last.

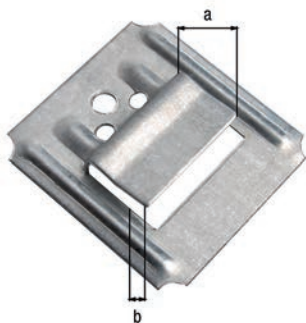

Profile board claw, blunt

profile board claw, packed in cardboard box

Accessory note: Nail pin included.

Dimension a	Dimension b	UNIT	PU	Contents per PU	Deliv-ery time	Order no. 4004338...
Material: raw steel, Surface: blue galvanised						
4 mm	2 mm	20	Box	250 Piece	L	351540

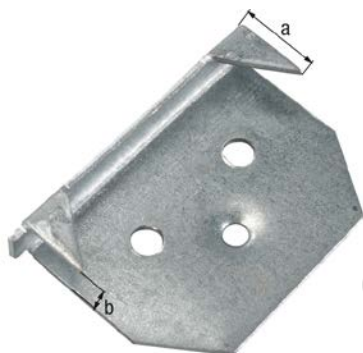

Starting claw

Accessory note: Nail pin included.

Dimension a	Dimension b	UNIT	PU	Contents per PU	Deliv-ery time	Order no. 4004338...
Material: raw steel, Surface: blue galvanised						
7 mm	4 mm	10	Pack	10 Piece	L	351458

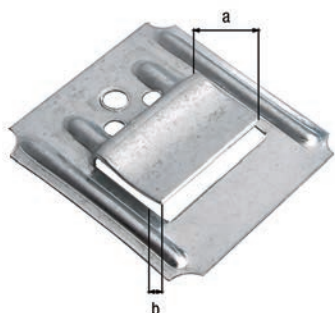

Profile board claw for plastic panels

profile board claw, packed in cardboard box

Accessory note: Nail pin included.

Dimension a	Dimension b	UNIT	PU	Contents per PU	Deliv-ery time	Order no. 4004338...
Material: raw steel, Surface: blue galvanised						
8 mm	1 mm	20	Box	250 Piece	L	351519

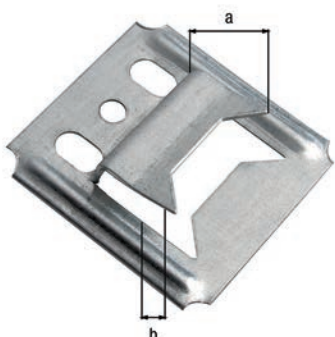

Profile board claw

profile board claw, packed in cardboard box

Accessory note: Nail pin included.

Dimension a	Dimension b	UNIT	PU	Contents per PU	Deliv-ery time	Order no. 4004338...
Material: raw steel, Surface: blue galvanised						
8 mm	2 mm	20	Box	250 Piece	L	351045
8 mm	3 mm	40	Box	100 Piece	L	351069
8 mm	3 mm	20	Box	250 Piece	L	351052
8 mm	4 mm	20	Box	250 Piece	L	351090
8 mm	5 mm	10	Box	250 Piece	L	351717

Nailing holder for mounting profile board claws

Dimension a	Dimension b-Ø	Dimension c-Ø	Dimension d	UNIT	PU	Contents per PU	Deliv-ery time	Order no. 4004338...
Material: plastic, with metal pin								
187 mm	32 mm	8 mm	137 mm	5	Blister	1 Piece	L	353186



Pliers for profile board claws

assembly aid for fixing panels

Dimension a	Dimension b	UNIT	PU	Contents per PU	Deliv-ery time	Order no. 4004338...
Material: raw steel, Surface: blue galvanised, with plastic handle						
203 mm	45 mm	5	Card	1 Piece	L	353179



WALL CONNECTORS

Made to last.

Bee-biter

Dimension a	Dimension b	Dimension c	UNIT	PU	Contents per PU	Deliv-ery time	Order no. 4004338...
Material: stainless steel							
39 mm	7.5 - 14 mm	50 mm	1	Bag	10 Piece	L	336639 VA

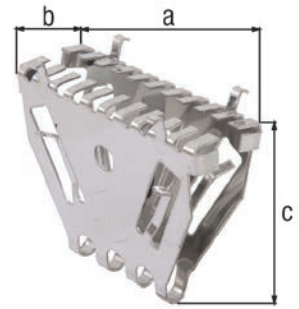

Wall clamp, rounded

Material thickness: 2.50 mm

Dimension a	Dimension b	UNIT	PU	Contents per PU	Deliv-ery time	Order no. 4004338...
Material: raw steel, Surface: sendzimir galvanised, for setting in concrete						
80 mm	30 mm	50	Piece	-	L	307776
110 mm	30 mm	50	Piece	-	L	307783
110 mm	30 mm	10	Pack	6 Piece	L	309411 GP
125 mm	30 mm	50	Piece	-	L	307790
140 mm	30 mm	50	Piece	-	L	307806
140 mm	30 mm	10	Pack	6 Piece	L	309435 GP
160 mm	30 mm	25	Piece	-	L	307813
160 mm	30 mm	10	Pack	6 Piece	L	309442 GP
190 mm	30 mm	25	Piece	-	L	307820
220 mm	30 mm	25	Piece	-	L	307837

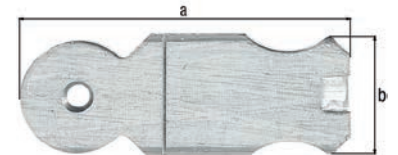

Connector, flat

Material thickness: 0.70 mm

Dimension a	Dimension b	UNIT	PU	Contents per PU	Deliv-ery time	Order no. 4004338...
Material: raw steel, Surface: sendzimir galvanised						
200 mm	22 mm	50	Piece	-	L	323806

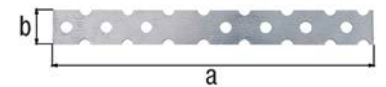

Connector, angled

Material thickness: 1.25 mm

Dimension a	Dimension b	Dimension c	UNIT	PU	Contents per PU	Deliv-ery time	Order no. 4004338...
Material: raw steel, Surface: sendzimir galvanised							
40 mm	68 mm	22 mm	50	Piece	-	L	323813

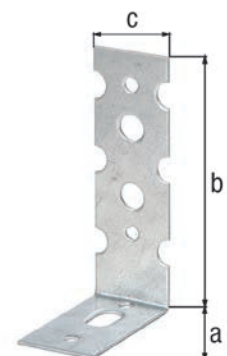

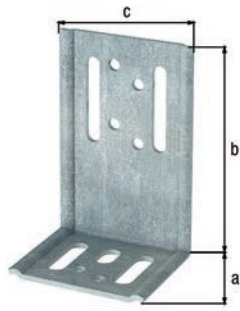

Angle bracket for facade cladding

Material thickness: 2.50 mm

Dimension a	Dimension b	Dimension c	UNIT	PU	Contents per PU	Deliv-ery time	Order no. 4004338...
Material: raw steel, Surface: sendzimir galvanised							
53 mm	98 mm	66 mm	50	Piece	-	L	330415
53 mm	118 mm	66 mm	50	Piece	-	L	330422
53 mm	138 mm	66 mm	50	Piece	-	L	330439
53 mm	158 mm	66 mm	50	Piece	-	L	330446

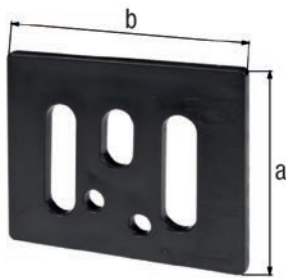

Square washer

to avoid cold bridges between wall and angle
Material thickness: 5.00 mm

Dimension a	Dimension b	UNIT	PU	Contents per PU	Deliv-ery time	Order no. 4004338...
Material: plastic						
53 mm	65 mm	50	Piece	-	L	330477

FLAGPOLES AND ACCESSORIES

Made to last.



Flagpole

Total height: 2000 mm

UNIT	PU	Contents per PU	Delivery time	Order no. 4004338...
Material: wood, Surface: white				
1	Piece	-	L	639006

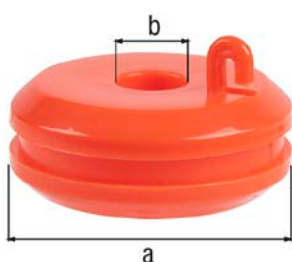

Cover cap for flagpoles

Dimension a-Ø	Dimension b-Ø	UNIT	PU	Contents per PU	Deliv- ery time	Order no. 4004338...
Material: plastic, colour: orange						
69.62 mm	17.88 mm	1	Piece	-	L	642198

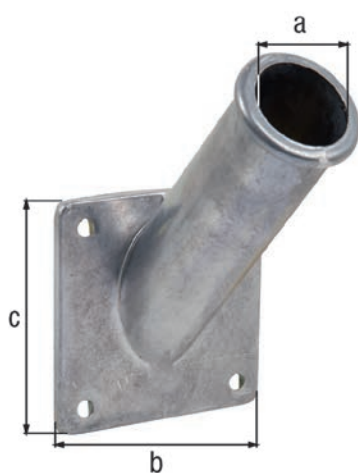

Holder for flagpoles for fixing on the wall

Dimension a-Ø	Dimension b	Dimension c	UNIT	PU	Contents per PU	Deliv- ery time	Order no. 4004338...
Material: aluminium							
30 mm	140 mm	95 mm	1	Piece	-	L	639105

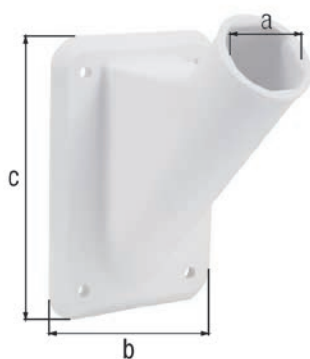

Holder for flagpoles for fixing on the wall

Dimension a-Ø	Dimension b	Dimension c	UNIT	PU	Contents per PU	Deliv- ery time	Order no. 4004338...
Material: plastic, colour: white							
30 mm	88 mm	126 mm	1	Piece	-	L	635190

Holder for flagpoles for fixing on the wall

for one flag

Insertion depth: 130 mm
Material thickness: 3.00 mm

Dimension a-Ø	Dimension b	Dimension c	UNIT	PU	Contents per PU	Deliv-ery time	Order no. 4004338...
Material: raw steel, Surface: blue galvanised							
29 mm	130 mm	70 mm	1	Piece	-	L	639662

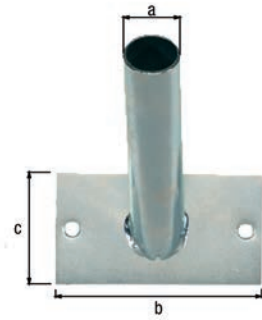

Holder for flagpoles for fixing on the wall

for two flags

Insertion depth: 130 mm
Material thickness: 3.00 mm

Dimension a-Ø	Dimension b	Dimension c	UNIT	PU	Contents per PU	Deliv-ery time	Order no. 4004338...
Material: raw steel, Surface: blue galvanised							
29 mm	130 mm	70 mm	1	Piece	-	L	639679

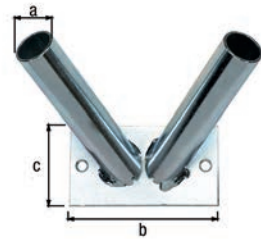

Holder for flagpoles for fixing on the wall

for three flags

Insertion depth: 130 mm
Material thickness: 3.00 mm

Dimension a-Ø	Dimension b	Dimension c	UNIT	PU	Contents per PU	Deliv-ery time	Order no. 4004338...
Material: raw steel, Surface: blue galvanised							
29 mm	175 mm	80 mm	1	Piece	-	L	639648

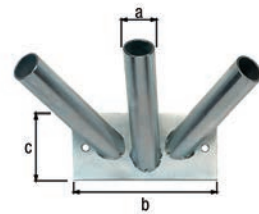

METAL SHEETS

Made to last.

Smooth sheet

Width	Length	Material thickness	UNIT	PU	Contents per PU	Deliv-ery time	Order no. 4004338...
Material: aluminium, Surface: untreated							
250 mm	500 mm	0.50 mm	1	Piece	-	L	464981
120 mm	1000 mm	0.50 mm	1	Piece	-	L	464967
200 mm	1000 mm	0.50 mm	1	Piece	-	L	464974
300 mm	1000 mm	0.50 mm	1	Piece	-	L	464998
600 mm	1000 mm	0.50 mm	1	Piece	-	L	465001
250 mm	500 mm	0.80 mm	1	Piece	-	L	466053
120 mm	1000 mm	0.80 mm	1	Piece	-	L	467821
200 mm	1000 mm	0.80 mm	1	Piece	-	L	468002
300 mm	1000 mm	0.80 mm	1	Piece	-	L	466039
600 mm	1000 mm	0.80 mm	1	Piece	-	L	466046
250 mm	500 mm	1.50 mm	1	Piece	-	L	466107
120 mm	1000 mm	1.50 mm	1	Piece	-	L	466060
200 mm	1000 mm	1.50 mm	1	Piece	-	L	466077
300 mm	1000 mm	1.50 mm	1	Piece	-	L	466084
600 mm	1000 mm	1.50 mm	1	Piece	-	L	466091



Smooth sheet

Width	Length	UNIT	PU	Contents per PU	Deliv-ery time	Order no. 4004338...
Material: aluminium, Surface: anodised, brushed stainless steel finish						
250 mm	500 mm	1	Piece	-	L	465964
120 mm	1000 mm	1	Piece	-	L	465957
300 mm	1000 mm	1	Piece	-	L	465971



Smooth sheet

Material thickness: 0.80 mm

Width	Length	UNIT	PU	Contents per PU	Deliv-ery time	Order no. 4004338...
Material: aluminium, Surface: white powder-coated						
240 mm	480 mm	1	Piece	-	L	466374



Textured sheet, diamond plate

Material thickness: 1.50 mm



Width	Length	UNIT	PU	Contents per PU	Deliv-ery time	Order no. 4004338...
Material: aluminium, Surface: untreated						
200 mm	500 mm	1	Piece	-	L	469405

Textured sheet, roughcast effect

Material thickness: 1.00 mm



Width	Length	UNIT	PU	Contents per PU	Deliv-ery time	Order no. 4004338...
Material: aluminium, Surface: untreated						
250 mm	500 mm	1	Piece	-	L	466633
120 mm	1000 mm	1	Piece	-	L	466596
200 mm	1000 mm	1	Piece	-	L	468354
300 mm	1000 mm	1	Piece	-	L	466619
600 mm	1000 mm	1	Piece	-	L	464721

Textured sheet, checker plate surface

• Slip resistance: tested in accordance with DIN 51130 and ASR A1.5/1,2. Suitable as a floor covering for use in working spaces and work areas with a risk of slipping, in which floor coverings of the evaluation group R10/V-.- are required.



Width	Length	Material thickness	UNIT	PU	Contents per PU	Deliv-ery time	Order no. 4004338...
Material: aluminium, Surface: untreated							
250 mm	500 mm	1.50 mm	1	Piece	-	L	466756
120 mm	1000 mm	1.50 mm	1	Piece	-	L	466695
200 mm	1000 mm	1.50 mm	1	Piece	-	L	468385
300 mm	1000 mm	1.50 mm	1	Piece	-	L	466718
600 mm	1000 mm	1.50 mm	1	Piece	-	L	466725
400 mm	2000 mm	1.50 mm	1	Piece	-	L	466732
300 mm	1000 mm	2.50 mm	1	Piece	-	L	466763
600 mm	1000 mm	2.50 mm	1	Piece	-	L	466770
600 mm	2000 mm	2.50 mm	1	Piece	-	L	466794

Textured sheet, design: hammered

Material thickness: 0.50 mm

Width	Length	UNIT	PU	Contents per PU	Deliv-ery time	Order no. 4004338...
Material: aluminium, Surface: untreated						
250 mm	500 mm	1	Piece	-	L	466534
120 mm	1000 mm	1	Piece	-	L	466497
200 mm	1000 mm	1	Piece	-	L	470777

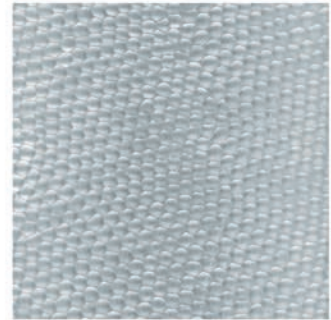

Textured sheet, square design

Material thickness: 1.00 mm

Width	Length	UNIT	PU	Contents per PU	Deliv-ery time	Order no. 4004338...
Material: aluminium, Surface: silver anodised						
250 mm	500 mm	1	Piece	-	L	466480
200 mm	1000 mm	1	Piece	-	L	466459
600 mm	1000 mm	1	Piece	-	L	466473



Perforated sheet, square holes

Hole: 10 x 10 mm

Distance from middle to middle of holes: 15 mm

Material thickness: 0.80 mm

Width	Length	UNIT	PU	Contents per PU	Deliv-ery time	Order no. 4004338...
Material: aluminium, Surface: silver anodised						
250 mm	500 mm	1	Piece	-	L	467142
200 mm	1000 mm	1	Piece	-	L	468163
500 mm	1000 mm	1	Piece	-	L	468187

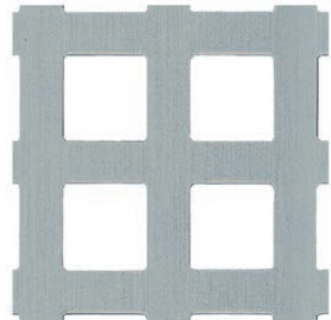

Perforated sheet, square holes

Hole: 10 x 10 mm

Distance from middle to middle of holes: 30 mm

Material thickness: 0.80 mm

Width	Length	UNIT	PU	Contents per PU	Deliv-ery time	Order no. 4004338...
Material: aluminium, Surface: silver anodised						
250 mm	500 mm	1	Piece	-	L	467197
300 mm	1000 mm	1	Piece	-	L	467173
600 mm	1000 mm	1	Piece	-	L	467180

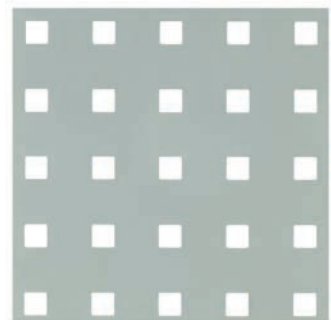



Perforated sheet, round holes

Hole-Ø 1: 2 mm
 Distance from middle to middle of holes: 3.5 mm
 Material thickness: 0.80 mm

Width	Length	UNIT	PU	Contents per PU	Deliv-ery time	Order no. 4004338...
Material: aluminium, Surface: untreated						
250 mm	500 mm	1	Piece	-	L	464240
120 mm	1000 mm	1	Piece	-	L	464233
200 mm	1000 mm	1	Piece	-	L	468200
300 mm	1000 mm	1	Piece	-	L	464257
600 mm	1000 mm	1	Piece	-	L	464264
Material: aluminium, Surface: silver anodised						
250 mm	500 mm	1	Piece	-	L	466947
200 mm	1000 mm	1	Piece	-	L	466916

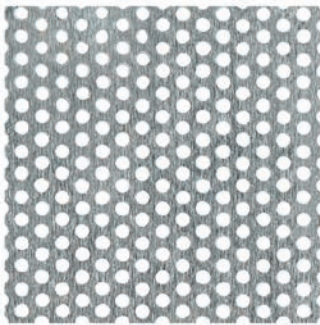

Perforated sheet, round holes

Hole-Ø 1: 3 mm
 Distance from middle to middle of holes: 5 mm
 Material thickness: 0.80 mm

Width	Length	UNIT	PU	Contents per PU	Deliv-ery time	Order no. 4004338...
Material: aluminium, Surface: silver anodised						
250 mm	500 mm	1	Piece	-	L	466992
200 mm	1000 mm	1	Piece	-	L	466961



Perforated sheet, round holes

Hole-Ø 1: 4.5 mm
 Distance from middle to middle of holes: 15 mm
 Material thickness: 1.50 mm

Width	Length	UNIT	PU	Contents per PU	Deliv-ery time	Order no. 4004338...
Material: aluminium, Surface: untreated						
250 mm	500 mm	1	Piece	-	L	467043
120 mm	1000 mm	1	Piece	-	L	467005



Perforated sheet, slotted perforation

Material thickness: 0.80 mm

Width	Length	UNIT	PU	Contents per PU	Deliv-ery time	Order no. 4004338...
Material: aluminium, Surface: silver anodised						
250 mm	500 mm	1	Piece	-	L	466848
200 mm	1000 mm	1	Piece	-	L	466817

Perforated sheet, cross perforation

Material thickness: 0.80 mm

Width	Length	UNIT	PU	Contents per PU	Deliv-ery time	Order no. 4004338...
Material: aluminium, Surface: silver anodised						
250 mm	500 mm	1	Piece	-	L	466893
200 mm	1000 mm	1	Piece	-	L	466862
600 mm	1000 mm	1	Piece	-	L	466886

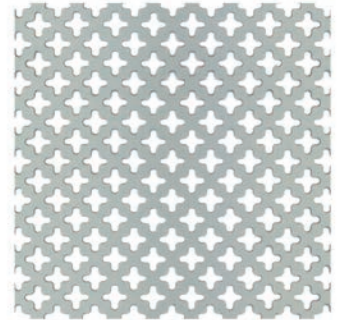

Expanded metal sheet

Material thickness: 1.00 mm

Width	Length	Dimension a	Dimension b	Dimension c	UNIT	PU	Contents per PU	Deliv-ery time	Order no. 4004338...
Material: aluminium, Surface: black anodised									
250 mm	500 mm	22 mm	10 mm	1.5 mm	1	Piece	-	L	465896
600 mm	1000 mm	22 mm	10 mm	1.5 mm	1	Piece	-	L	465919



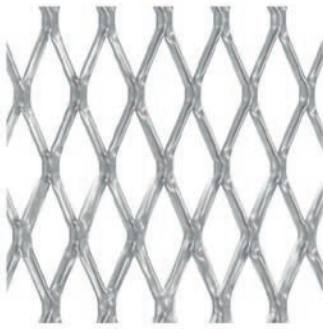

Expanded metal sheet

Material thickness: 1.60 mm

Width	Length	Dimension a	Dimension b	Dimension c	UNIT	PU	Contents per PU	Deliv-ery time	Order no. 4004338...
Material: aluminium, Surface: silver anodised									
250 mm	500 mm	10.3 mm	5 mm	1 mm	1	Piece	-	L	467241
300 mm	1000 mm	10.3 mm	5 mm	1 mm	1	Piece	-	L	467227
Material: aluminium, Surface: gold anodised									
250 mm	500 mm	10.3 mm	5 mm	1 mm	1	Piece	-	L	467296
300 mm	1000 mm	10.3 mm	5 mm	1 mm	1	Piece	-	L	467272
600 mm	1000 mm	10.3 mm	5 mm	1 mm	1	Piece	-	L	467289



Smooth sheet

Material thickness: 0.50 mm

	Width	Length	UNIT	PU	Contents per PU	Deliv-ery time	Order no. 4004338...
Material: stainless steel							
VA	250 mm	500 mm	1	Piece	-	L	467463
VA	120 mm	1000 mm	1	Piece	-	L	467456



Smooth sheet

	Width	Length	Material thickness	UNIT	PU	Contents per PU	Deliv-ery time	Order no. 4004338...
Material: copper								
	200 mm	500 mm	0.50 mm	1	Piece	-	L	470210
	500 mm	1000 mm	0.50 mm	1	Piece	-	L	469511

Smooth sheet

Width	Length	Material thickness	UNIT	PU	Contents per PU	Deliv-ery time	Order no. 4004338...
Material: brass							
200 mm	500 mm	0.50 mm	1	Piece	-	L	470012
200 mm	1000 mm	0.80 mm	1	Piece	-	L	470654



Smooth sheet

Width	Length	Material thickness	UNIT	PU	Contents per PU	Deliv-ery time	Order no. 4004338...
Material: raw steel							
250 mm	500 mm	0.75 mm	1	Piece	-	L	466275
200 mm	1000 mm	0.75 mm	1	Piece	-	L	468576
600 mm	1000 mm	0.75 mm	1	Piece	-	L	466268
Material: raw steel, Surface: galvanised							
250 mm	500 mm	0.50 mm	1	Piece	-	L	466237
120 mm	1000 mm	0.50 mm	1	Piece	-	L	466206
300 mm	1000 mm	0.50 mm	1	Piece	-	L	466213
600 mm	1000 mm	0.50 mm	1	Piece	-	L	466220
250 mm	500 mm	0.75 mm	1	Piece	-	L	465834
120 mm	1000 mm	0.75 mm	1	Piece	-	L	465810
200 mm	1000 mm	0.75 mm	1	Piece	-	L	465827
300 mm	1000 mm	0.75 mm	1	Piece	-	L	465841
600 mm	1000 mm	0.75 mm	1	Piece	-	L	465858

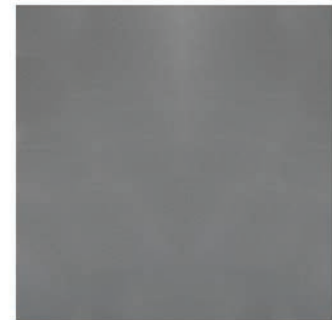

Perforated sheet, square holes

Hole: 5 x 5 mm

Distance from middle to middle of holes: 8 mm

Material thickness: 1.00 mm

Width	Length	UNIT	PU	Contents per PU	Deliv-ery time	Order no. 4004338...
Material: raw steel						
250 mm	500 mm	1	Piece	-	L	463106
500 mm	1000 mm	1	Piece	-	L	462895

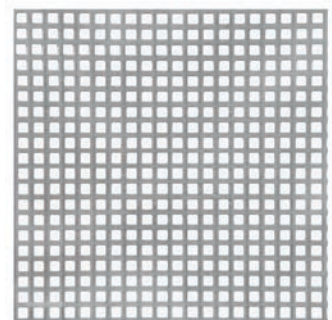

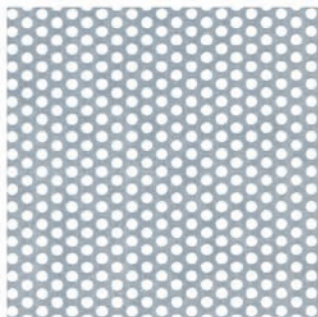

Perforated sheet, round holes

Hole-Ø 1: 4.5 mm
 Distance from middle to middle of holes: 15 mm
 Material thickness: 1.50 mm

Width	Length	UNIT	PU	Contents per PU	Deliv-ery time	Order no. 4004338...
Material: raw steel, Surface: galvanised						
300 mm	1000 mm	1	Piece	-	L	467074



Perforated sheet, round holes

Hole-Ø 1: 8 mm
 Distance from middle to middle of holes: 11 mm
 Material thickness: 1.00 mm

Width	Length	UNIT	PU	Contents per PU	Deliv-ery time	Order no. 4004338...
Material: raw steel						
250 mm	500 mm	1	Piece	-	L	462994

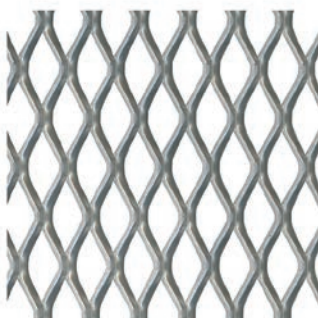

Expanded metal sheet

Width	Length	Material thickness	Dimension a	Dimension b	Dimension c	UNIT	PU	Contents per PU	Deliv-ery time	Order no. 4004338...
Material: raw steel										
250 mm	500 mm	1.20 mm	6 mm	3.4 mm	0.6 mm	1	Piece	-	L	467340
300 mm	1000 mm	1.20 mm	6 mm	3.4 mm	0.6 mm	1	Piece	-	L	467326
600 mm	1000 mm	1.20 mm	6 mm	3.4 mm	0.6 mm	1	Piece	-	L	467333
250 mm	500 mm	2.20 mm	10 mm	7.5 mm	1.0 mm	1	Piece	-	L	467395
120 mm	1000 mm	2.20 mm	10 mm	7.5 mm	1.0 mm	1	Piece	-	L	467357
300 mm	1000 mm	2.20 mm	10 mm	7.5 mm	1.0 mm	1	Piece	-	L	467371
250 mm	500 mm	2.80 mm	16 mm	8.0 mm	1.5 mm	1	Piece	-	L	467449
120 mm	1000 mm	2.80 mm	16 mm	8.0 mm	1.5 mm	1	Piece	-	L	467401



Smooth sheet, angled, L-shape

Distortion: 90 °
Material thickness: 0.50 mm

Length	Dimension a	Dimension b	UNIT	PU	Contents per PU	Deliv-ery time	Order no. 4004338...
Material: aluminium, Surface: untreated							
1000 mm	50 mm	50 mm	1	Piece	-	L	462901
1000 mm	68 mm	30 mm	1	Piece	-	L	462918
1000 mm	96 mm	28 mm	1	Piece	-	L	462925
1000 mm	135 mm	30 mm	1	Piece	-	L	462932
2000 mm	50 mm	50 mm	1	Piece	-	L	462802
2000 mm	68 mm	30 mm	1	Piece	-	L	462819
2000 mm	96 mm	28 mm	1	Piece	-	L	462826
2000 mm	135 mm	30 mm	1	Piece	-	L	462833

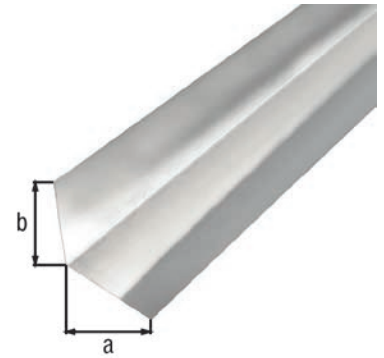

Textured sheet, checker plate surface, angled, L-shape

Distortion: 90 °
Material thickness: 1.50 mm

Length	Dimension a	Dimension b	UNIT	PU	Contents per PU	Deliv-ery time	Order no. 4004338...
Material: aluminium, Surface: untreated							
1000 mm	135 mm	30 mm	1	Piece	-	L	462949
2000 mm	135 mm	30 mm	1	Piece	-	L	462840

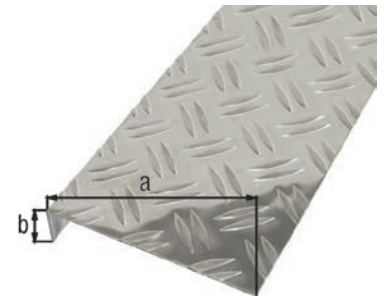

Smooth sheet, angled, Z-shape

Distortion: 90 °
Material thickness: 0.50 mm

Length	Dimension a	Dimension b	Dimension c	UNIT	PU	Contents per PU	Deliv-ery time	Order no. 4004338...
Material: aluminium, Surface: untreated								
1000 mm	18 mm	63 mm	18 mm	1	Piece	-	L	462956
2000 mm	18 mm	63 mm	18 mm	1	Piece	-	L	462857

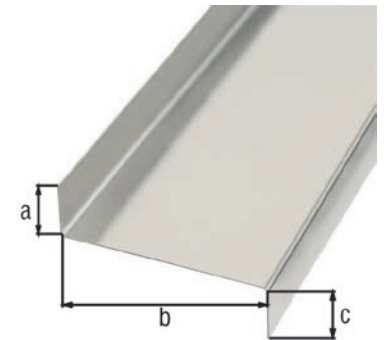

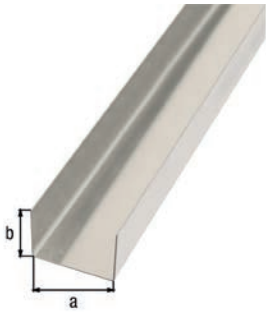

Smooth sheet, angled, U-shape

Distortion: 90 °

Material thickness: 0.50 mm

Length	Dimension a	Dimension b	UNIT	PU	Contents per PU	Deliv-ery time	Order no. 4004338...
Material: aluminium, Surface: untreated							
1000 mm	29 mm	20 mm	1	Piece	-	L	462963
1000 mm	58 mm	20 mm	1	Piece	-	L	462970
1000 mm	130 mm	18 mm	1	Piece	-	L	462987
2000 mm	29 mm	20 mm	1	Piece	-	L	462864
2000 mm	58 mm	20 mm	1	Piece	-	L	462871
2000 mm	130 mm	18 mm	1	Piece	-	L	462888

Corner protection, checker plate surface



Dimension a	Dimension b	UNIT	PU	Contents per PU	Deliv-ery time	Order no. 4004338...
Material: aluminium, Surface: untreated						
23.5 mm	23.5 mm	1	Piece	-	L	467654
29.5 mm	29.5 mm	1	Piece	-	L	467661
35.5 mm	35.5 mm	1	Piece	-	L	467678

Edge protection profile

flexible, easily bendable material
for all sheets up to 2 mm thick to protect from sharp edges
Length: 1500 mm

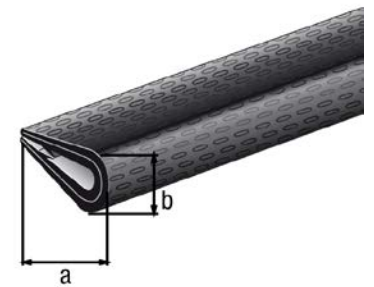

Dimension a	Dimension b	UNIT	PU	Contents per PU	Deliv-ery time	Order no. 4004338...
Material: soft PVC, colour: black						
10 mm	7 mm	3	Pack	1 Piece	L	426859

ALUMINIUM PROFILES

Made to last.

BA-Profile, flat

Length	Dimension a	Dimension b	UNIT	PU	Contents per PU	Delivery time	Order no. 4004338...
Material: aluminium, Surface: untreated							
1000 mm	15 mm	2 mm	1	Piece	-	L	469375
1000 mm	20 mm	2 mm	1	Piece	-	L	473488
1000 mm	20 mm	5 mm	1	Piece	-	L	469887
1000 mm	25 mm	2 mm	1	Piece	-	L	469894
1000 mm	30 mm	2 mm	1	Piece	-	L	473709
1000 mm	40 mm	3 mm	1	Piece	-	L	469917
1000 mm	50 mm	3 mm	1	Piece	-	L	488178
1000 mm	60 mm	3 mm	1	Piece	-	L	492458
1000 mm	70 mm	3 mm	1	Piece	-	L	473976
1000 mm	80 mm	3 mm	1	Piece	-	L	473990
2000 mm	20 mm	2 mm	1	Piece	-	L	473501
2000 mm	20 mm	5 mm	1	Piece	-	L	469962
2000 mm	25 mm	2 mm	1	Piece	-	L	469979
2000 mm	30 mm	2 mm	1	Piece	-	L	472023
2000 mm	40 mm	2 mm	1	Piece	-	L	472030
2000 mm	50 mm	3 mm	1	Piece	-	L	472047
2000 mm	60 mm	3 mm	1	Piece	-	L	472054
2000 mm	70 mm	3 mm	1	Piece	-	L	474089
2000 mm	80 mm	3 mm	1	Piece	-	L	474102
2600 mm	15 mm	2 mm	1	Piece	-	L	492595
2600 mm	20 mm	2 mm	1	Piece	-	L	433048
2600 mm	20 mm	5 mm	1	Piece	-	L	470197
2600 mm	25 mm	2 mm	1	Piece	-	L	433505
2600 mm	30 mm	2 mm	1	Piece	-	L	472184
2600 mm	40 mm	2 mm	1	Piece	-	L	463267
2600 mm	50 mm	3 mm	1	Piece	-	L	492229
2600 mm	60 mm	3 mm	1	Piece	-	L	488185
Material: aluminium, Surface: white powder-coated RAL 9016							
1000 mm	30 mm	2 mm	1	Piece	-	L	474201
2000 mm	20 mm	2 mm	1	Piece	-	L	474379
2600 mm	20 mm	2 mm	1	Piece	-	L	479848
2600 mm	30 mm	2 mm	1	Piece	-	L	479855
2600 mm	50 mm	3 mm	1	Piece	-	L	492601

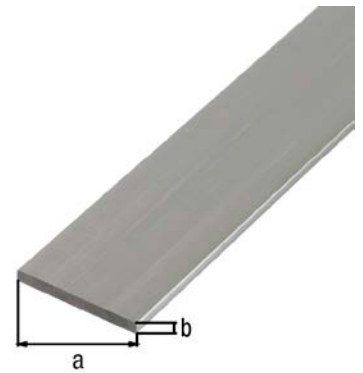

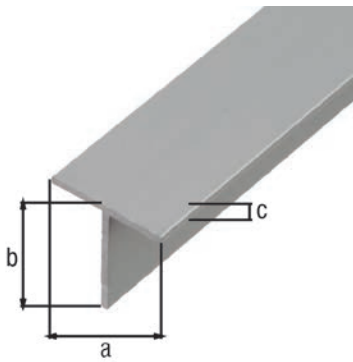

BA-Profile, T shape

Length	Dimension a	Dimension b	Dimension c	UNIT	PU	Contents per PU	Deliv-ery time	Order no. 4004338...
Material: aluminium, Surface: untreated								
1000 mm	15 mm	15 mm	1.5 mm	1	Piece	-	L	472092
1000 mm	20 mm	20 mm	1.5 mm	1	Piece	-	L	472108
1000 mm	35 mm	35 mm	3.0 mm	1	Piece	-	L	464899
2000 mm	15 mm	15 mm	1.5 mm	1	Piece	-	L	472153
2000 mm	20 mm	20 mm	1.5 mm	1	Piece	-	L	472160
2000 mm	35 mm	35 mm	3.0 mm	1	Piece	-	L	472115
2600 mm	15 mm	15 mm	1.5 mm	1	Piece	-	L	499877
2600 mm	20 mm	20 mm	1.5 mm	1	Piece	-	L	492540
2600 mm	35 mm	35 mm	3.0 mm	1	Piece	-	L	470425
Material: aluminium, Surface: white powder-coated RAL 9016								
2600 mm	15 mm	15 mm	1.5 mm	1	Piece	-	L	479954
2600 mm	25 mm	25 mm	2.0 mm	1	Piece	-	L	479961



BA-Bar, round

Length	Dimension a-Ø	UNIT	PU	Contents per PU	Deliv-ery time	Order no. 4004338...
Material: aluminium, Surface: untreated						
1000 mm	4 mm	1	Piece	-	L	473778
1000 mm	6 mm	1	Piece	-	L	473945
1000 mm	8 mm	1	Piece	-	L	474096
1000 mm	10 mm	1	Piece	-	L	474287
1000 mm	12 mm	1	Piece	-	L	488147
2600 mm	4 mm	1	Piece	-	L	492441
2600 mm	6 mm	1	Piece	-	L	499785
2600 mm	8 mm	1	Piece	-	L	470371
2600 mm	10 mm	1	Piece	-	L	470364
2600 mm	12 mm	1	Piece	-	L	463489

BA-Profile, round

Length	Dimension a-Ø	Dimension b	UNIT	PU	Contents per PU	Deliv-ery time	Order no. 4004338...
Material: aluminium, Surface: untreated							
1000 mm	6 mm	1.0 mm	1	Piece	-	L	473754
1000 mm	8 mm	1.0 mm	1	Piece	-	L	472481
1000 mm	10 mm	1.0 mm	1	Piece	-	L	472498
1000 mm	12 mm	1.0 mm	1	Piece	-	L	472504
1000 mm	15 mm	1.0 mm	1	Piece	-	L	472573
1000 mm	20 mm	1.0 mm	1	Piece	-	L	472580
1000 mm	25 mm	1.5 mm	1	Piece	-	L	472597
1000 mm	30 mm	2.0 mm	1	Piece	-	L	492434
2000 mm	10 mm	1.0 mm	1	Piece	-	L	469900
2000 mm	20 mm	1.0 mm	1	Piece	-	L	472313
2000 mm	30 mm	2.0 mm	1	Piece	-	L	472320
2600 mm	6 mm	1.0 mm	1	Piece	-	L	463281
2600 mm	8 mm	1.0 mm	1	Piece	-	L	469382
2600 mm	10 mm	1.0 mm	1	Piece	-	L	488161
2600 mm	12 mm	1.0 mm	1	Piece	-	L	468996
2600 mm	15 mm	1.0 mm	1	Piece	-	L	492212
2600 mm	20 mm	1.0 mm	1	Piece	-	L	463472
2600 mm	25 mm	1.5 mm	1	Piece	-	L	488192
2600 mm	30 mm	2.0 mm	1	Piece	-	L	470180
Material: aluminium, Surface: white powder-coated RAL 9016							
2600 mm	25 mm	1.5 mm	1	Piece	-	L	479879

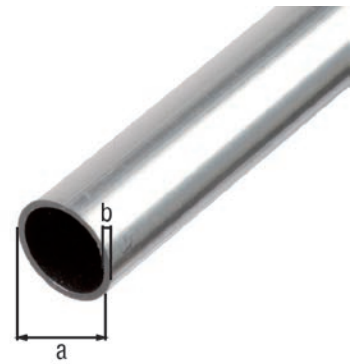

BA-Bar, square

Length	Dimension a	Dimension b	UNIT	PU	Contents per PU	Deliv-ery time	Order no. 4004338...
Material: aluminium, Surface: untreated							
1000 mm	10 mm	10 mm	1	Piece	-	L	470098
1000 mm	12 mm	12 mm	1	Piece	-	L	470296

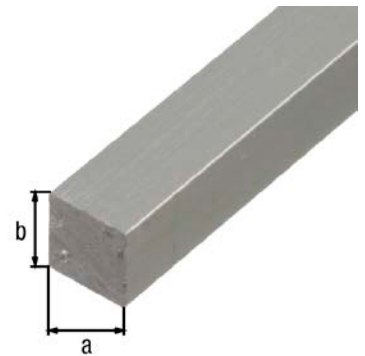

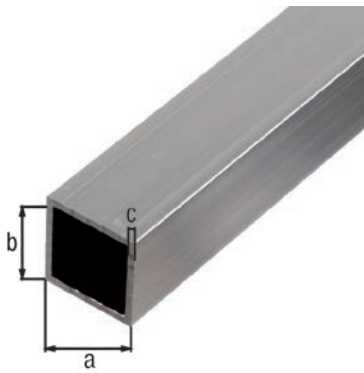

BA-Profile, square

Length	Dimension a	Dimension b	Dimension c	UNIT	PU	Contents per PU	Deliv-ery time	Order no. 4004338...
Material: aluminium, Surface: untreated								
1000 mm	10 mm	10 mm	1.0 mm	1	Piece	-	L	474157
1000 mm	15 mm	15 mm	1.0 mm	1	Piece	-	L	472801
1000 mm	20 mm	20 mm	1.5 mm	1	Piece	-	L	472856
1000 mm	25 mm	25 mm	1.5 mm	1	Piece	-	L	472863
1000 mm	30 mm	30 mm	2.0 mm	1	Piece	-	L	488116
1000 mm	40 mm	40 mm	2.0 mm	1	Piece	-	L	470128
2000 mm	15 mm	15 mm	1.0 mm	1	Piece	-	L	469870
2000 mm	20 mm	20 mm	1.5 mm	1	Piece	-	L	472429
2000 mm	25 mm	25 mm	1.5 mm	1	Piece	-	L	472436
2000 mm	30 mm	30 mm	2.0 mm	1	Piece	-	L	472443
2000 mm	40 mm	40 mm	2.0 mm	1	Piece	-	L	472450
2600 mm	15 mm	15 mm	1.0 mm	1	Piece	-	L	470340
2600 mm	20 mm	20 mm	1.5 mm	1	Piece	-	L	492564
2600 mm	25 mm	25 mm	1.5 mm	1	Piece	-	L	469931
2600 mm	30 mm	30 mm	2.0 mm	1	Piece	-	L	464950
2600 mm	40 mm	40 mm	2.0 mm	1	Piece	-	L	499860
Material: aluminium, Surface: white powder-coated RAL 9016								
2600 mm	20 mm	20 mm	1.5 mm	1	Piece	-	L	479886
2600 mm	30 mm	30 mm	2.0 mm	1	Piece	-	L	479893

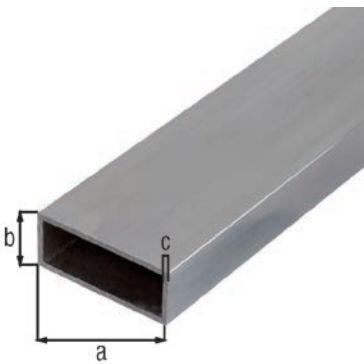

BA-Profile, rectangular

Length	Dimension a	Dimension b	Dimension c	UNIT	PU	Contents per PU	Deliv-ery time	Order no. 4004338...
Material: aluminium, Surface: untreated								
1000 mm	50 mm	20 mm	2 mm	1	Piece	-	L	472979
2000 mm	50 mm	20 mm	2 mm	1	Piece	-	L	472511
2600 mm	50 mm	20 mm	2 mm	1	Piece	-	L	470166
Material: aluminium, Surface: white powder-coated RAL 9016								
2600 mm	30 mm	20 mm	2 mm	1	Piece	-	L	479909
2600 mm	40 mm	20 mm	2 mm	1	Piece	-	L	479916

BA-Profile, angle

Type: equal sided

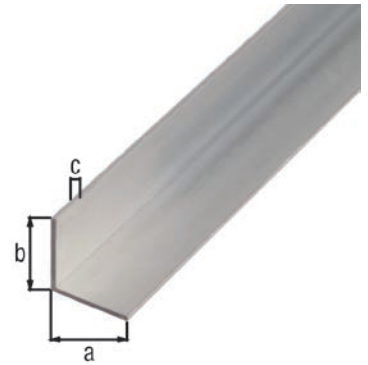

Length	Dimension a	Dimension b	Dimension c	UNIT	PU	Contents per PU	Deliv-ery time	Order no. 4004338...
Material: aluminium, Surface: untreated								
1000 mm	10 mm	10 mm	1.0 mm	1	Piece	-	L	473938
1000 mm	15 mm	15 mm	1.0 mm	1	Piece	-	L	473075
1000 mm	20 mm	20 mm	1.5 mm	1	Piece	-	L	473082
1000 mm	25 mm	25 mm	1.5 mm	1	Piece	-	L	473099
1000 mm	30 mm	30 mm	2.0 mm	1	Piece	-	L	473105
1000 mm	35 mm	35 mm	1.5 mm	1	Piece	-	L	473921
1000 mm	40 mm	40 mm	2.0 mm	1	Piece	-	L	473266
1000 mm	50 mm	50 mm	3.0 mm	1	Piece	-	L	488109
1000 mm	60 mm	60 mm	3.0 mm	1	Piece	-	L	473372
1000 mm	70 mm	70 mm	3.0 mm	1	Piece	-	L	473389
1000 mm	80 mm	80 mm	3.0 mm	1	Piece	-	L	474171
2000 mm	10 mm	10 mm	1.0 mm	1	Piece	-	L	473907
2000 mm	15 mm	15 mm	1.0 mm	1	Piece	-	L	472610
2000 mm	20 mm	20 mm	1.5 mm	1	Piece	-	L	472627
2000 mm	25 mm	25 mm	1.5 mm	1	Piece	-	L	472634
2000 mm	30 mm	30 mm	1.5 mm	1	Piece	-	L	472641
2000 mm	35 mm	35 mm	1.5 mm	1	Piece	-	L	474249
2000 mm	40 mm	40 mm	2.0 mm	1	Piece	-	L	472658
2000 mm	50 mm	50 mm	3.0 mm	1	Piece	-	L	472665
2000 mm	60 mm	60 mm	3.0 mm	1	Piece	-	L	474133
2000 mm	70 mm	70 mm	3.0 mm	1	Piece	-	L	474140
2000 mm	80 mm	80 mm	3.0 mm	1	Piece	-	L	474164
2600 mm	10 mm	10 mm	1.0 mm	1	Piece	-	L	470227
2600 mm	15 mm	15 mm	1.0 mm	1	Piece	-	L	472177
2600 mm	20 mm	20 mm	1.5 mm	1	Piece	-	L	472146
2600 mm	25 mm	25 mm	1.5 mm	1	Piece	-	L	472139
2600 mm	30 mm	30 mm	1.5 mm	1	Piece	-	L	472085
2600 mm	35 mm	35 mm	1.5 mm	1	Piece	-	L	431587
2600 mm	40 mm	40 mm	2.0 mm	1	Piece	-	L	468965
2600 mm	50 mm	50 mm	3.0 mm	1	Piece	-	L	470005
Material: aluminium, Surface: white powder-coated RAL 9016								
2000 mm	20 mm	20 mm	1.5 mm	1	Piece	-	L	473969
2000 mm	25 mm	25 mm	1.5 mm	1	Piece	-	L	474195
2000 mm	30 mm	30 mm	2.0 mm	1	Piece	-	L	474256
2000 mm	15 mm	15 mm	1.0 mm	1	Piece	-	L	474270
2600 mm	20 mm	20 mm	1.5 mm	1	Piece	-	L	474935
2600 mm	25 mm	25 mm	1.5 mm	1	Piece	-	L	474942
2600 mm	30 mm	30 mm	2.0 mm	1	Piece	-	L	474966
2600 mm	50 mm	50 mm	3.0 mm	1	Piece	-	L	474973
2600 mm	15 mm	15 mm	1.0 mm	1	Piece	-	L	474997

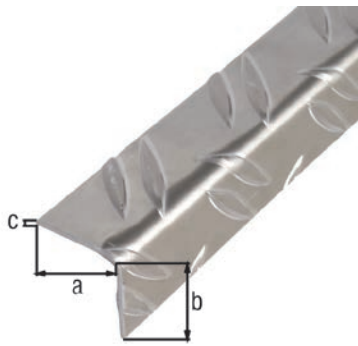

Angle profile, checker plate

Type: equal sided

Length	Dimension a	Dimension b	Dimension c	UNIT	PU	Contents per PU	Deliv-ery time	Order no. 4004338...
Material: aluminium, Surface: raw								
1000 mm	23.5 mm	23.5 mm	1.5 mm	1	Piece	-	L	468842
1000 mm	29.5 mm	29.5 mm	1.5 mm	1	Piece	-	L	468859
1000 mm	35.5 mm	35.5 mm	1.5 mm	1	Piece	-	L	468866
1000 mm	41.2 mm	41.2 mm	1.5 mm	1	Piece	-	L	468873
2000 mm	23.5 mm	23.5 mm	1.5 mm	1	Piece	-	L	467692
2000 mm	29.5 mm	29.5 mm	1.5 mm	1	Piece	-	L	467708
2000 mm	35.5 mm	35.5 mm	1.5 mm	1	Piece	-	L	467715
2000 mm	41.2 mm	41.2 mm	1.5 mm	1	Piece	-	L	467722

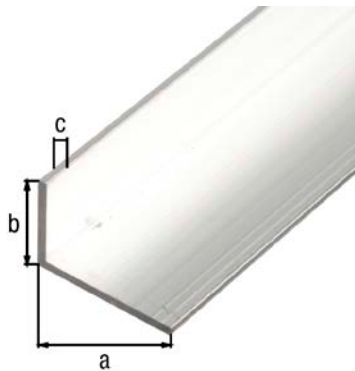

BA-Profile, angle

Type: unequal sided

Length	Dimension a	Dimension b	Dimension c	UNIT	PU	Contents per PU	Deliv-ery time	Order no. 4004338...
Material: aluminium, Surface: untreated								
1000 mm	15 mm	10 mm	1.5 mm	1	Piece	-	L	470302
1000 mm	20 mm	10 mm	1.5 mm	1	Piece	-	L	470463
1000 mm	25 mm	15 mm	1.5 mm	1	Piece	-	L	465995
1000 mm	30 mm	15 mm	2.0 mm	1	Piece	-	L	499822
1000 mm	30 mm	20 mm	2.0 mm	1	Piece	-	L	473983
1000 mm	40 mm	10 mm	2.0 mm	1	Piece	-	L	492175
1000 mm	40 mm	20 mm	2.0 mm	1	Piece	-	L	474003
1000 mm	50 mm	20 mm	2.0 mm	1	Piece	-	L	474072
1000 mm	50 mm	30 mm	3.0 mm	1	Piece	-	L	470241
1000 mm	65 mm	35 mm	2.5 mm	1	Piece	-	L	492182
1000 mm	70 mm	40 mm	3.0 mm	1	Piece	-	L	473365
2000 mm	20 mm	10 mm	1.5 mm	1	Piece	-	L	472719
2000 mm	30 mm	15 mm	2.0 mm	1	Piece	-	L	472726
2000 mm	30 mm	20 mm	2.0 mm	1	Piece	-	L	472733
2000 mm	40 mm	20 mm	2.0 mm	1	Piece	-	L	474188
2000 mm	50 mm	30 mm	3.0 mm	1	Piece	-	L	472764
2000 mm	70 mm	40 mm	3.0 mm	1	Piece	-	L	476991
2600 mm	15 mm	10 mm	1.0 mm	1	Piece	-	L	431570
2600 mm	20 mm	10 mm	1.5 mm	1	Piece	-	L	470081
2600 mm	25 mm	15 mm	1.5 mm	1	Piece	-	L	487881
2600 mm	30 mm	15 mm	2.0 mm	1	Piece	-	L	469399
2600 mm	30 mm	20 mm	2.0 mm	1	Piece	-	L	499808
2600 mm	40 mm	10 mm	2.0 mm	1	Piece	-	L	492502
2600 mm	40 mm	20 mm	2.0 mm	1	Piece	-	L	492496
2600 mm	50 mm	20 mm	2.0 mm	1	Piece	-	L	465018
2600 mm	50 mm	30 mm	3.0 mm	1	Piece	-	L	470494
2600 mm	65 mm	35 mm	2.5 mm	1	Piece	-	L	488222
Material: aluminium, Surface: white powder-coated RAL 9016								
2600 mm	20 mm	10 mm	1.5 mm	1	Piece	-	L	475086
2600 mm	30 mm	20 mm	2.0 mm	1	Piece	-	L	475093

Angle profile, checker plate

Type: unequal sided

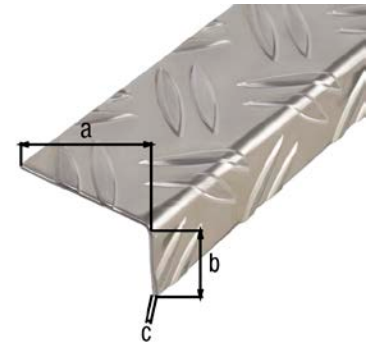

Length	Dimension a	Dimension b	Dimension c	UNIT	PU	Contents per PU	Deliv-ery time	Order no. 4004338...
Material: aluminium, Surface: raw								
1000 mm	43.5 mm	23.5 mm	1.5 mm	1	Piece	-	L	468903
1000 mm	53.6 mm	29.5 mm	1.5 mm	1	Piece	-	L	468910
1000 mm	65.6 mm	35.5 mm	1.5 mm	1	Piece	-	L	468927
2000 mm	43.5 mm	23.5 mm	1.5 mm	1	Piece	-	L	468934
2000 mm	53.6 mm	29.5 mm	1.5 mm	1	Piece	-	L	468941

BA-Profile, U shape

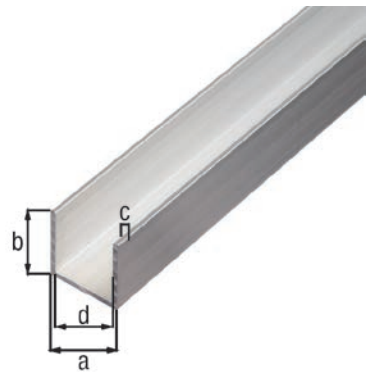

Length	Dimension a	Dimension b	Dimension c	Dimension d	UNIT	PU	Contents per PU	Deliv-ery time	Order no. 4004338...
Material: aluminium, Surface: untreated									
1000 mm	6 mm	6 mm	1.0 mm	4 mm	1	Piece	-	L	473808
1000 mm	8 mm	8 mm	1.0 mm	6 mm	1	Piece	-	L	475659
1000 mm	10 mm	8 mm	1.0 mm	8 mm	1	Piece	-	L	470449
1000 mm	10 mm	10 mm	1.0 mm	8 mm	1	Piece	-	L	475666
1000 mm	15 mm	10 mm	1.5 mm	12 mm	1	Piece	-	L	492519
1000 mm	15 mm	15 mm	1.5 mm	12 mm	1	Piece	-	L	474362
1000 mm	15 mm	20 mm	1.5 mm	12 mm	1	Piece	-	L	475697
1000 mm	16 mm	13 mm	1.5 mm	13 mm	1	Piece	-	L	492465
1000 mm	20 mm	10 mm	1.5 mm	17 mm	1	Piece	-	L	474409
1000 mm	20 mm	20 mm	1.5 mm	17 mm	1	Piece	-	L	474485
1000 mm	25 mm	25 mm	2.0 mm	21 mm	1	Piece	-	L	470357
1000 mm	30 mm	20 mm	2.0 mm	26 mm	1	Piece	-	L	488130
2000 mm	8 mm	8 mm	1.0 mm	6 mm	1	Piece	-	L	475765
2000 mm	10 mm	8 mm	1.0 mm	8 mm	1	Piece	-	L	475772
2000 mm	15 mm	15 mm	1.5 mm	12 mm	1	Piece	-	L	475789
2000 mm	15 mm	20 mm	1.5 mm	12 mm	1	Piece	-	L	475796
2000 mm	20 mm	20 mm	1.5 mm	17 mm	1	Piece	-	L	472818
2000 mm	25 mm	25 mm	2.0 mm	21 mm	1	Piece	-	L	472825
2000 mm	30 mm	20 mm	2.0 mm	26 mm	1	Piece	-	L	475352
2600 mm	8 mm	8 mm	1.0 mm	6 mm	1	Piece	-	L	464943
2600 mm	10 mm	8 mm	1.0 mm	8 mm	1	Piece	-	L	463496
2600 mm	10 mm	10 mm	1.5 mm	7 mm	1	Piece	-	L	468989
2600 mm	10 mm	15 mm	1.5 mm	7 mm	1	Piece	-	L	431532
2600 mm	15 mm	10 mm	1.5 mm	12 mm	1	Piece	-	L	488154
2600 mm	15 mm	15 mm	1.5 mm	12 mm	1	Piece	-	L	431549
2600 mm	15 mm	20 mm	1.5 mm	12 mm	1	Piece	-	L	470388
2600 mm	16 mm	13 mm	1.5 mm	13 mm	1	Piece	-	L	464868
2600 mm	20 mm	10 mm	1.5 mm	17 mm	1	Piece	-	L	470142
2600 mm	20 mm	20 mm	1.5 mm	17 mm	1	Piece	-	L	431556
2600 mm	25 mm	25 mm	2.0 mm	21 mm	1	Piece	-	L	470104
2600 mm	30 mm	20 mm	2.0 mm	26 mm	1	Piece	-	L	492199
Material: aluminium, Surface: white powder-coated RAL 9016									
2600 mm	10 mm	10 mm	1.0 mm	8 mm	1	Piece	-	L	479923
2600 mm	15 mm	15 mm	1.5 mm	12 mm	1	Piece	-	L	479930
2600 mm	20 mm	20 mm	1.5 mm	17 mm	1	Piece	-	L	479947



U profile, checker plate

Length	Dimension a	Dimension b	Dimension c	UNIT	PU	Contents per PU	Deliv-ery time	Order no. 4004338...
Material: aluminium, Surface: raw								
1000 mm	23.5 mm	23.5 mm	1.5 mm	1	Piece	-	L	468880
1000 mm	29.5 mm	29.5 mm	1.5 mm	1	Piece	-	L	468897
2000 mm	23.5 mm	23.5 mm	1.5 mm	1	Piece	-	L	467739
2000 mm	29.5 mm	29.5 mm	1.5 mm	1	Piece	-	L	467746

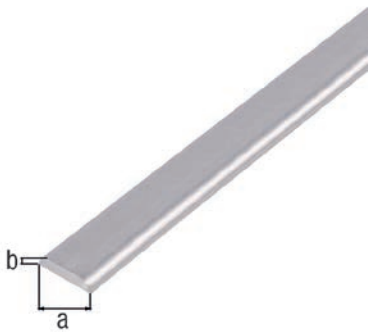

BA-Cover profile with rounded edges

Length: 1000 mm

Dimension a	Dimension b	UNIT	PU	Contents per PU	Deliv-ery time	Order no. 4004338...
Material: aluminium, Surface: untreated						
19 mm	4 mm	1	Piece	-	L	469993
24 mm	4 mm	1	Piece	-	L	470029

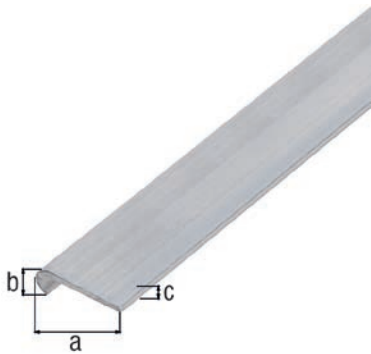

BA-End profile, round

Length	Dimension a	Dimension b	Dimension c	UNIT	PU	Contents per PU	Deliv-ery time	Order no. 4004338...
Material: aluminium, Surface: untreated								
1000 mm	20 mm	6 mm	1.3 mm	1	Piece	-	L	470067
1000 mm	26 mm	6 mm	1.3 mm	1	Piece	-	L	470289
2000 mm	26 mm	6 mm	1.3 mm	1	Piece	-	L	470326

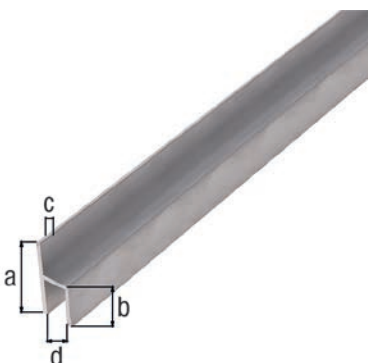

BA-Profile, chair shape

Length	Dimension a	Dimension b	Dimension c	Dimension d	UNIT	PU	Contents per PU	Deliv-ery time	Order no. 4004338...
Material: aluminium, Surface: untreated									
1000 mm	26 mm	11 mm	1.5 mm	8 mm	1	Piece	-	L	469955
2000 mm	26 mm	11 mm	1.5 mm	8 mm	1	Piece	-	L	469986

ALUMINIUM PROFILES, ANODISED

Made to last.

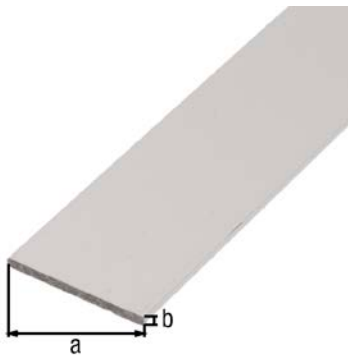

Flat bar

Length	Dimension a	Dimension b	UNIT	PU	Contents per PU	Deliv-ery time	Order no. 4004338...
Material: aluminium, Surface: silver anodised							
1000 mm	15 mm	2 mm	1	Piece	-	L	473013
1000 mm	20 mm	2 mm	1	Piece	-	L	473020
1000 mm	20 mm	5 mm	1	Piece	-	L	473068
1000 mm	25 mm	2 mm	1	Piece	-	L	473037
1000 mm	30 mm	2 mm	1	Piece	-	L	473044
1000 mm	40 mm	3 mm	1	Piece	-	L	473051
1000 mm	50 mm	3 mm	1	Piece	-	L	471729
1000 mm	60 mm	3 mm	1	Piece	-	L	471743
2000 mm	15 mm	2 mm	1	Piece	-	L	474010
2000 mm	20 mm	2 mm	1	Piece	-	L	474027
2000 mm	20 mm	5 mm	1	Piece	-	L	474065
2000 mm	25 mm	2 mm	1	Piece	-	L	474034
2000 mm	30 mm	2 mm	1	Piece	-	L	474041
2000 mm	40 mm	3 mm	1	Piece	-	L	474058
2000 mm	50 mm	3 mm	1	Piece	-	L	471736
2000 mm	60 mm	3 mm	1	Piece	-	L	471750
2600 mm	15 mm	2 mm	1	Piece	-	L	480288
2600 mm	20 mm	2 mm	1	Piece	-	L	480196
2600 mm	25 mm	2 mm	1	Piece	-	L	480271
2600 mm	30 mm	2 mm	1	Piece	-	L	480165
2600 mm	40 mm	3 mm	1	Piece	-	L	480684
2600 mm	50 mm	3 mm	1	Piece	-	L	480820
Material: aluminium, Surface: black anodised							
1000 mm	15 mm	2 mm	1	Piece	-	L	489366
1000 mm	20 mm	2 mm	1	Piece	-	L	489373
2000 mm	15 mm	2 mm	1	Piece	-	L	489380
2000 mm	20 mm	2 mm	1	Piece	-	L	489397
1000 mm	30 mm	2 mm	1	Piece	-	L	472917
2000 mm	30 mm	2 mm	1	Piece	-	L	472924

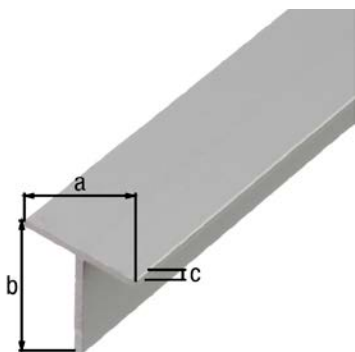

T profile

Length	Dimension a	Dimension b	Dimension c	UNIT	PU	Contents per PU	Deliv-ery time	Order no. 4004338...
Material: aluminium, Surface: silver anodised								
1000 mm	15 mm	15 mm	1.5 mm	1	Piece	-	L	473112
1000 mm	20 mm	20 mm	1.5 mm	1	Piece	-	L	473129
1000 mm	35 mm	35 mm	3.0 mm	1	Piece	-	L	471866
2000 mm	15 mm	15 mm	1.5 mm	1	Piece	-	L	474119
2000 mm	20 mm	20 mm	1.5 mm	1	Piece	-	L	474126
2000 mm	35 mm	35 mm	3.0 mm	1	Piece	-	L	471873

Round bar

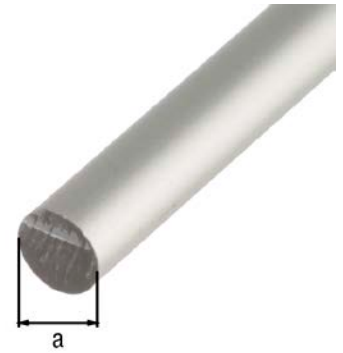

Length	Dimension a-Ø	UNIT	PU	Contents per PU	Deliv-ery time	Order no. 4004338...
Material: aluminium, Surface: silver anodised						
1000 mm	5 mm	1	Piece	-	L	473310
1000 mm	6 mm	1	Piece	-	L	473327
1000 mm	8 mm	1	Piece	-	L	473334
1000 mm	10 mm	1	Piece	-	L	473341
1000 mm	12 mm	1	Piece	-	L	473358
2000 mm	5 mm	1	Piece	-	L	474317
2000 mm	6 mm	1	Piece	-	L	474324
2000 mm	8 mm	1	Piece	-	L	474331
2000 mm	10 mm	1	Piece	-	L	474348
2000 mm	12 mm	1	Piece	-	L	474355

Round tube

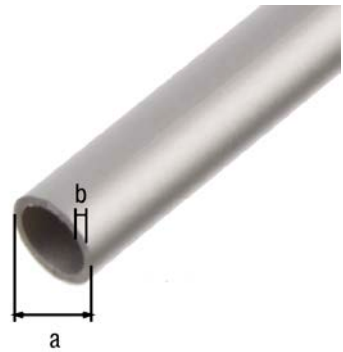

Length	Dimension a-Ø	Dimension b	UNIT	PU	Contents per PU	Deliv-ery time	Order no. 4004338...
Material: aluminium, Surface: silver anodised							
1000 mm	6 mm	1.0 mm	1	Piece	-	L	473419
1000 mm	8 mm	1.0 mm	1	Piece	-	L	473426
1000 mm	10 mm	1.0 mm	1	Piece	-	L	473433
1000 mm	12 mm	1.0 mm	1	Piece	-	L	473440
1000 mm	15 mm	1.0 mm	1	Piece	-	L	473457
1000 mm	20 mm	1.0 mm	1	Piece	-	L	473464
1000 mm	25 mm	1.5 mm	1	Piece	-	L	473471
1000 mm	30 mm	2.0 mm	1	Piece	-	L	471767
2000 mm	6 mm	1.0 mm	1	Piece	-	L	474416
2000 mm	8 mm	1.0 mm	1	Piece	-	L	474423
2000 mm	10 mm	1.0 mm	1	Piece	-	L	474430
2000 mm	12 mm	1.0 mm	1	Piece	-	L	474447
2000 mm	15 mm	1.0 mm	1	Piece	-	L	474454
2000 mm	20 mm	1.0 mm	1	Piece	-	L	474461
2000 mm	25 mm	1.5 mm	1	Piece	-	L	474478
2000 mm	30 mm	2.0 mm	1	Piece	-	L	471774
2600 mm	12 mm	1.0 mm	1	Piece	-	L	480660
2600 mm	15 mm	1.0 mm	1	Piece	-	L	480585
2600 mm	25 mm	1.5 mm	1	Piece	-	L	480653
Material: aluminium, Surface: black anodised							
1000 mm	8 mm	1.0 mm	1	Piece	-	L	472931
2000 mm	8 mm	1.0 mm	1	Piece	-	L	472948

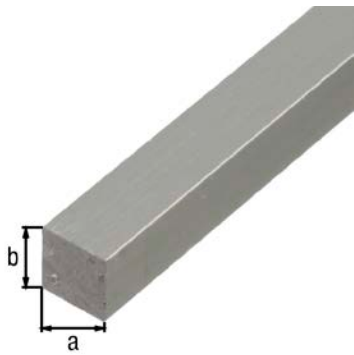

Square bar

Length	Dimension a	Dimension b	UNIT	PU	Contents per PU	Deliv-ery time	Order no. 4004338...
Material: aluminium, Surface: silver anodised							
1000 mm	10 mm	10 mm	1	Piece	-	L	473211
1000 mm	12 mm	12 mm	1	Piece	-	L	473228
1000 mm	16 mm	16 mm	1	Piece	-	L	473235
2000 mm	10 mm	10 mm	1	Piece	-	L	474218

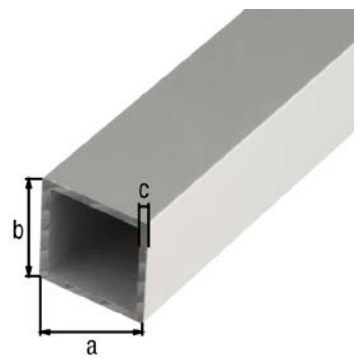

Square tube

Length	Dimension a	Dimension b	Dimension c	UNIT	PU	Contents per PU	Deliv-ery time	Order no. 4004338...
Material: aluminium, Surface: silver anodised								
1000 mm	10 mm	10 mm	1.0 mm	1	Piece	-	L	473518
1000 mm	15 mm	15 mm	1.0 mm	1	Piece	-	L	473525
1000 mm	20 mm	20 mm	1.5 mm	1	Piece	-	L	473532
1000 mm	25 mm	25 mm	1.5 mm	1	Piece	-	L	473549
1000 mm	30 mm	30 mm	2.0 mm	1	Piece	-	L	471644
1000 mm	40 mm	40 mm	2.0 mm	1	Piece	-	L	471668
1000 mm	50 mm	50 mm	2.0 mm	1	Piece	-	L	471682
2000 mm	10 mm	10 mm	1.0 mm	1	Piece	-	L	474515
2000 mm	15 mm	15 mm	1.0 mm	1	Piece	-	L	474522
2000 mm	20 mm	20 mm	1.5 mm	1	Piece	-	L	474539
2000 mm	25 mm	25 mm	1.5 mm	1	Piece	-	L	474546
2000 mm	30 mm	30 mm	2.0 mm	1	Piece	-	L	471651
2000 mm	40 mm	40 mm	2.0 mm	1	Piece	-	L	471675
2000 mm	50 mm	50 mm	2.0 mm	1	Piece	-	L	471699
2600 mm	15 mm	15 mm	1.0 mm	1	Piece	-	L	480639
2600 mm	20 mm	20 mm	1.5 mm	1	Piece	-	L	480264
2600 mm	25 mm	25 mm	1.5 mm	1	Piece	-	L	480479
2600 mm	30 mm	30 mm	2.0 mm	1	Piece	-	L	480646

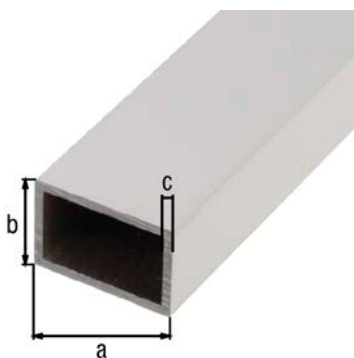

Rectangular tube

Length	Dimension a	Dimension b	Dimension c	UNIT	PU	Contents per PU	Deliv-ery time	Order no. 4004338...
Material: aluminium, Surface: silver anodised								
1000 mm	50 mm	20 mm	2 mm	1	Piece	-	L	471705
2000 mm	50 mm	20 mm	2 mm	1	Piece	-	L	471712

Angle profile

Type: equal sided

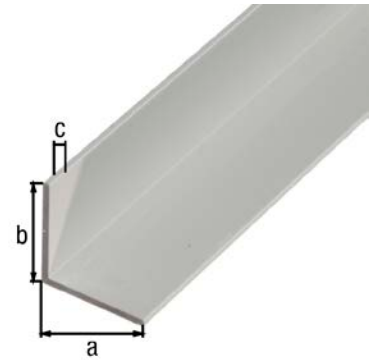

Length	Dimension a	Dimension b	Dimension c	UNIT	PU	Contents per PU	Deliv-ery time	Order no. 4004338...
Material: aluminium, Surface: silver anodised								
1000 mm	10 mm	10 mm	1.0 mm	1	Piece	-	L	473617
1000 mm	15 mm	15 mm	1.0 mm	1	Piece	-	L	473624
1000 mm	20 mm	20 mm	1.5 mm	1	Piece	-	L	473631
1000 mm	25 mm	25 mm	1.5 mm	1	Piece	-	L	473648
1000 mm	30 mm	30 mm	2.0 mm	1	Piece	-	L	473655
1000 mm	40 mm	40 mm	2.0 mm	1	Piece	-	L	473662
1000 mm	50 mm	50 mm	3.0 mm	1	Piece	-	L	471828
1000 mm	60 mm	60 mm	4.0 mm	1	Piece	-	L	471842
2000 mm	10 mm	10 mm	1.0 mm	1	Piece	-	L	474614
2000 mm	15 mm	15 mm	1.0 mm	1	Piece	-	L	474621
2000 mm	20 mm	20 mm	1.5 mm	1	Piece	-	L	474638
2000 mm	25 mm	25 mm	1.5 mm	1	Piece	-	L	474645
2000 mm	30 mm	30 mm	2.0 mm	1	Piece	-	L	474652
2000 mm	40 mm	40 mm	2.0 mm	1	Piece	-	L	474669
2000 mm	50 mm	50 mm	3.0 mm	1	Piece	-	L	471835
2600 mm	10 mm	10 mm	1.0 mm	1	Piece	-	L	480172
2600 mm	15 mm	15 mm	1.0 mm	1	Piece	-	L	431662
2600 mm	20 mm	20 mm	1.5 mm	1	Piece	-	L	472078
2600 mm	25 mm	25 mm	1.5 mm	1	Piece	-	L	479978
2600 mm	30 mm	30 mm	2.0 mm	1	Piece	-	L	479985
2600 mm	40 mm	40 mm	2.0 mm	1	Piece	-	L	479992
Material: aluminium, Surface: gold anodised								
1000 mm	10 mm	10 mm	2.0 mm	1	Piece	-	L	473556
1000 mm	15 mm	15 mm	1.0 mm	1	Piece	-	L	473563
1000 mm	20 mm	20 mm	1.5 mm	1	Piece	-	L	473570
1000 mm	25 mm	25 mm	1.5 mm	1	Piece	-	L	473587
1000 mm	30 mm	30 mm	2.0 mm	1	Piece	-	L	473594
1000 mm	40 mm	40 mm	2.0 mm	1	Piece	-	L	473600
Material: aluminium, Surface: bronze colour anodised								
1000 mm	15 mm	15 mm	1.0 mm	1	Piece	-	L	480011
1000 mm	20 mm	20 mm	1.5 mm	1	Piece	-	L	480028
1000 mm	25 mm	25 mm	1.5 mm	1	Piece	-	L	480035
1000 mm	30 mm	30 mm	2.0 mm	1	Piece	-	L	480042
Material: aluminium, Surface: black anodised								
1000 mm	10 mm	10 mm	1.0 mm	1	Piece	-	L	488284
1000 mm	15 mm	15 mm	1.0 mm	1	Piece	-	L	488291
1000 mm	20 mm	20 mm	1.0 mm	1	Piece	-	L	489304
2000 mm	10 mm	10 mm	1.0 mm	1	Piece	-	L	489328
2000 mm	15 mm	15 mm	1.0 mm	1	Piece	-	L	489335
2000 mm	20 mm	20 mm	1.0 mm	1	Piece	-	L	489342
1000 mm	25 mm	25 mm	1.0 mm	1	Piece	-	L	472955
2000 mm	25 mm	25 mm	1.0 mm	1	Piece	-	L	472962
1000 mm	30 mm	30 mm	1.3 mm	1	Piece	-	L	472986
2000 mm	30 mm	30 mm	1.3 mm	1	Piece	-	L	472993

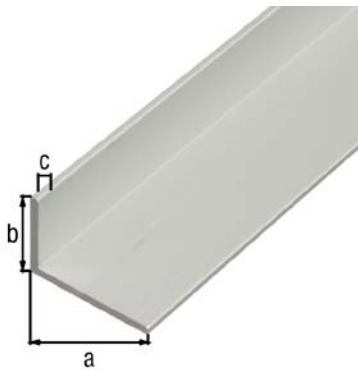

Angle profile

Type: unequal sided

Length	Dimension a	Dimension b	Dimension c	UNIT	PU	Contents per PU	Deliv-ery time	Order no. 4004338...
Material: aluminium, Surface: silver anodised								
1000 mm	15 mm	10 mm	1.5 mm	1	Piece	-	L	473716
1000 mm	20 mm	10 mm	1.5 mm	1	Piece	-	L	473723
1000 mm	25 mm	15 mm	1.5 mm	1	Piece	-	L	473730
1000 mm	30 mm	15 mm	2.0 mm	1	Piece	-	L	471781
1000 mm	30 mm	20 mm	2.0 mm	1	Piece	-	L	473747
1000 mm	40 mm	10 mm	2.0 mm	1	Piece	-	L	473792
1000 mm	40 mm	20 mm	2.0 mm	1	Piece	-	L	473761
1000 mm	50 mm	20 mm	2.0 mm	1	Piece	-	L	472535
1000 mm	50 mm	30 mm	3.0 mm	1	Piece	-	L	473785
1000 mm	60 mm	25 mm	2.0 mm	1	Piece	-	L	471804
2000 mm	15 mm	10 mm	1.5 mm	1	Piece	-	L	474713
2000 mm	20 mm	10 mm	1.5 mm	1	Piece	-	L	474720
2000 mm	25 mm	15 mm	1.5 mm	1	Piece	-	L	474737
2000 mm	30 mm	15 mm	2.0 mm	1	Piece	-	L	471798
2000 mm	30 mm	20 mm	2.0 mm	1	Piece	-	L	474744
2000 mm	40 mm	10 mm	2.0 mm	1	Piece	-	L	474799
2000 mm	40 mm	20 mm	2.0 mm	1	Piece	-	L	474768
2000 mm	50 mm	30 mm	3.0 mm	1	Piece	-	L	474782
2000 mm	60 mm	25 mm	2.0 mm	1	Piece	-	L	471811
2600 mm	15 mm	10 mm	1.5 mm	1	Piece	-	L	480462
2600 mm	20 mm	10 mm	1.5 mm	1	Piece	-	L	480097
2600 mm	25 mm	15 mm	1.5 mm	1	Piece	-	L	480080
2600 mm	30 mm	20 mm	2.0 mm	1	Piece	-	L	480073
2600 mm	40 mm	10 mm	2.0 mm	1	Piece	-	L	480189
2600 mm	40 mm	20 mm	2.0 mm	1	Piece	-	L	480066
2600 mm	60 mm	25 mm	2.0 mm	1	Piece	-	L	480677
Material: aluminium, Surface: black anodised								
1000 mm	20 mm	10 mm	1.0 mm	1	Piece	-	L	489311
2000 mm	20 mm	10 mm	1.0 mm	1	Piece	-	L	489359

U profile

Length	Dimension a	Dimension b	Dimension c	Dimension d	UNIT	PU	Contents per PU	Delivery time	Order no. 4004338...
Material: aluminium, Surface: silver anodised									
1000 mm	8.6 mm	12 mm	1.3 mm	6.0 mm	1	Piece	-	L	473884
1000 mm	10 mm	8 mm	1.3 mm	7.4 mm	1	Piece	-	L	473815
1000 mm	12 mm	10 mm	1.5 mm	9.0 mm	1	Piece	-	L	473822
1000 mm	15 mm	8 mm	1.5 mm	12.0 mm	1	Piece	-	L	471927
1000 mm	15 mm	10 mm	1.5 mm	12.0 mm	1	Piece	-	L	473846
1000 mm	15 mm	15 mm	1.5 mm	12.0 mm	1	Piece	-	L	471941
1000 mm	16 mm	13 mm	1.5 mm	13.0 mm	1	Piece	-	L	473839
1000 mm	18 mm	20 mm	1.3 mm	15.4 mm	1	Piece	-	L	473860
1000 mm	20 mm	8 mm	1.0 mm	18.0 mm	1	Piece	-	L	471903
1000 mm	20 mm	10 mm	1.5 mm	17.0 mm	1	Piece	-	L	473853
1000 mm	20 mm	20 mm	1.5 mm	17.0 mm	1	Piece	-	L	473877
1000 mm	22 mm	10 mm	1.5 mm	19.0 mm	1	Piece	-	L	473891
1000 mm	25 mm	25 mm	2.0 mm	21.0 mm	1	Piece	-	L	471965
2000 mm	8.6 mm	12 mm	1.3 mm	6.0 mm	1	Piece	-	L	474881
2000 mm	10 mm	8 mm	1.3 mm	7.4 mm	1	Piece	-	L	474812
2000 mm	12 mm	10 mm	1.5 mm	9.0 mm	1	Piece	-	L	474829
2000 mm	15 mm	8 mm	1.5 mm	12.0 mm	1	Piece	-	L	471934
2000 mm	15 mm	10 mm	1.5 mm	12.0 mm	1	Piece	-	L	474843
2000 mm	15 mm	15 mm	1.5 mm	12.0 mm	1	Piece	-	L	471958
2000 mm	16 mm	13 mm	1.5 mm	13.0 mm	1	Piece	-	L	474836
2000 mm	18 mm	20 mm	1.3 mm	15.4 mm	1	Piece	-	L	474867
2000 mm	20 mm	8 mm	1.0 mm	18.0 mm	1	Piece	-	L	471910
2000 mm	20 mm	10 mm	1.5 mm	17.0 mm	1	Piece	-	L	474850
2000 mm	20 mm	20 mm	1.5 mm	17.0 mm	1	Piece	-	L	474874
2000 mm	22 mm	10 mm	1.5 mm	19.0 mm	1	Piece	-	L	474898
2000 mm	25 mm	25 mm	2.0 mm	21.0 mm	1	Piece	-	L	471972
2600 mm	8.6 mm	12 mm	1.3 mm	6.0 mm	1	Piece	-	L	480837
2600 mm	15 mm	10 mm	1.5 mm	12.0 mm	1	Piece	-	L	480486
2600 mm	15 mm	15 mm	1.5 mm	12.0 mm	1	Piece	-	L	480844
2600 mm	20 mm	20 mm	1.5 mm	17.0 mm	1	Piece	-	L	480295
2600 mm	25 mm	25 mm	2.0 mm	21.0 mm	1	Piece	-	L	480691

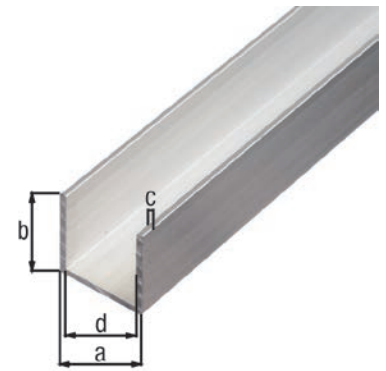

U profile for chipboard panels

For thickness: 16 - 19 mm

Length	Dimension a	Dimension b	Dimension c	Dimension d	UNIT	PU	Contents per PU	Delivery time	Order no. 4004338...
Material: aluminium, Surface: silver anodised									
1000 mm	19 mm	15 mm	1.5 mm	16 mm	1	Piece	-	L	485603
1000 mm	22 mm	15 mm	1.5 mm	19 mm	1	Piece	-	L	485610
2000 mm	19 mm	15 mm	1.5 mm	16 mm	1	Piece	-	L	485641
2000 mm	22 mm	15 mm	1.5 mm	19 mm	1	Piece	-	L	485658

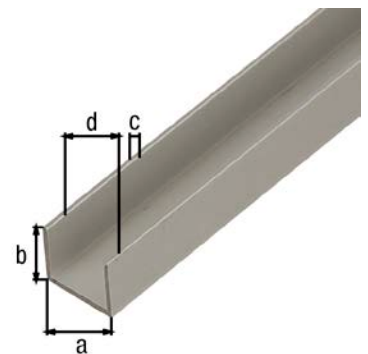

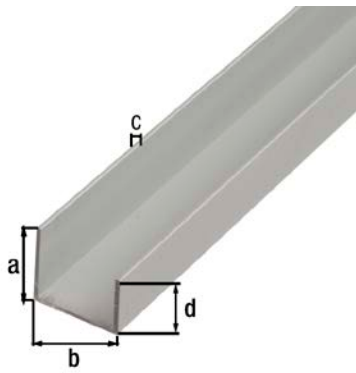

U profile

Type: unequal sided
Length: 1000 mm

Dimension a	Dimension b	Dimension c	Dimension d	UNIT	PU	Contents per PU	Deliv-ery time	Order no. 4004338...
Material: aluminium, Surface: silver anodised								
22 mm	20 mm	1.5 mm	15 mm	1	Piece	-	L	475192

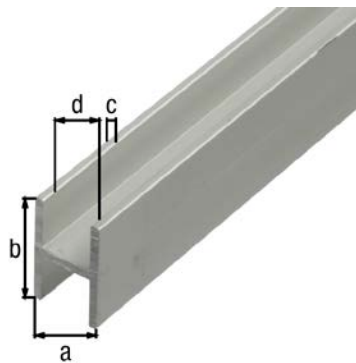

H profile

Length	Dimension a	Dimension b	Dimension c	Dimension d	UNIT	PU	Contents per PU	Deliv-ery time	Order no. 4004338...
Material: aluminium, Surface: silver anodised									
1000 mm	9.1 mm	12 mm	1.3 mm	6.5 mm	1	Piece	-	L	473914
1000 mm	13.5 mm	22 mm	1.5 mm	10.0 mm	1	Piece	-	L	473952
2000 mm	9.1 mm	12 mm	1.3 mm	6.5 mm	1	Piece	-	L	474911
2000 mm	13.5 mm	22 mm	1.5 mm	10.0 mm	1	Piece	-	L	474959

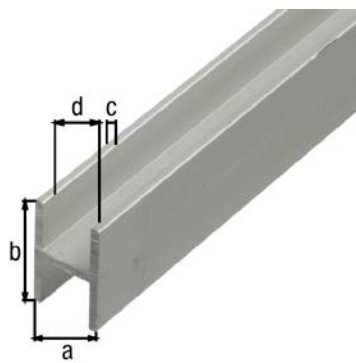

H profile for chipboard panels

For thickness: 16 - 19 mm

Length	Dimension a	Dimension b	Dimension c	Dimension d	UNIT	PU	Contents per PU	Deliv-ery time	Order no. 4004338...
Material: aluminium, Surface: silver anodised									
1000 mm	19 mm	30 mm	1.5 mm	16 mm	1	Piece	-	L	485627
1000 mm	22 mm	30 mm	1.5 mm	19 mm	1	Piece	-	L	485634
2000 mm	22 mm	30 mm	1.5 mm	19 mm	1	Piece	-	L	485672

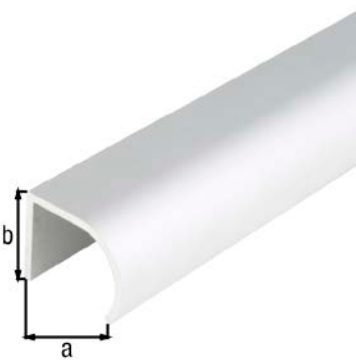

Grip profile, rounded

Material thickness: 1.75 mm

Length	Dimension a	Dimension b	UNIT	PU	Contents per PU	Deliv-ery time	Order no. 4004338...
Material: aluminium, Surface: silver anodised							
1000 mm	25 mm	19 mm	1	Piece	-	L	475253
2000 mm	25 mm	19 mm	1	Piece	-	L	472009

Grip profile, angled

Length: 2000 mm

Dimension a	Dimension b	Dimension c	Dimension d	UNIT	PU	Contents per PU	Delivery time	Order no.
Material: aluminium, Surface: silver anodised								
40 mm	13 mm	2.5 mm	3.4 mm	1	Piece	-	L	472061

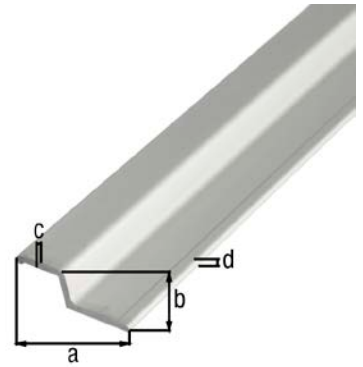

Edge protection profile with chamfered edges

Length	Dimension a	Dimension b	Dimension c	UNIT	PU	Contents per PU	Delivery time	Order no.
Material: aluminium, Surface: silver anodised								
1000 mm	14 mm	10 mm	1.5 mm	1	Piece	-	L	475178
1000 mm	19.6 mm	8.6 mm	1.6 mm	1	Piece	-	L	475154
2000 mm	14 mm	10 mm	1.5 mm	1	Piece	-	L	475185
2000 mm	19.6 mm	8.6 mm	1.6 mm	1	Piece	-	L	475161

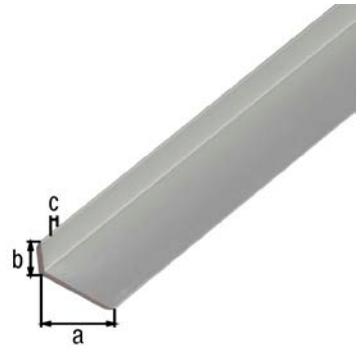

End profile, round

Length: 1000 mm

Dimension a	Dimension b	Dimension c	UNIT	PU	Contents per PU	Delivery time	Order no.
Material: aluminium, Surface: silver anodised							
26 mm	6 mm	13 mm	1	Piece	-	L	470524

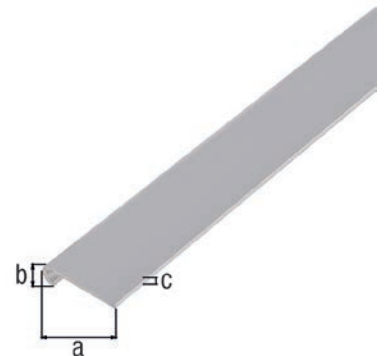

Chair profile

Length: 1000 mm

Dimension a	Dimension b	Dimension c	Dimension d	UNIT	PU	Contents per PU	Delivery time	Order no.
Material: aluminium, Surface: silver anodised								
26 mm	15 mm	1.5 mm	8 mm	1	Piece	-	L	470487

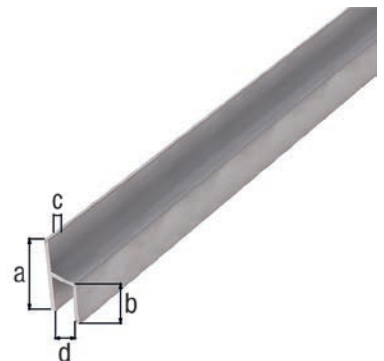

T cover profile

Material thickness: 1.00 mm

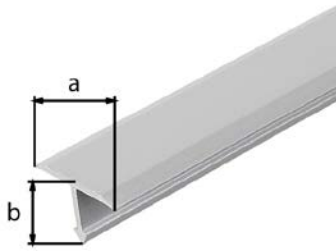

Length	Dimension a	Dimension b	UNIT	PU	Contents per PU	Deliv-ery time	Order no. 4004338...
Material: aluminium, Surface: silver anodised							
1000 mm	15 mm	9 mm	1	Piece	-	L	477103
1000 mm	25 mm	9 mm	1	Piece	-	L	477110
2600 mm	15 mm	9 mm	1	Piece	-	L	476694
2600 mm	25 mm	9 mm	1	Piece	-	L	476700

C profile

Material thickness: 2.00 mm

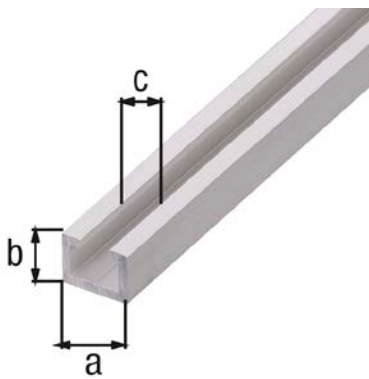

Length	Dimension a	Dimension b	Dimension c	UNIT	PU	Contents per PU	Deliv-ery time	Order no. 4004338...
Material: aluminium, Surface: silver anodised								
1000 mm	14 mm	10 mm	6 mm	1	Piece	-	L	492618
2000 mm	14 mm	10 mm	6 mm	1	Piece	-	L	492625
1000 mm	17 mm	11 mm	8 mm	1	Piece	-	L	492632
2000 mm	17 mm	11 mm	8 mm	1	Piece	-	L	492649

ALUMINIUM PROFILES, DECORATIVE SURFACES

Made to last.

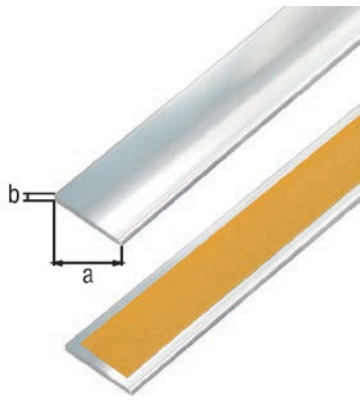

Flat bar, self-adhesive

Length	Dimension a	Dimension b	UNIT	PU	Contents per PU	Deliv-ery time	Order no. 4004338...
Material: aluminium, Surface: chrome design							
1000 mm	15 mm	2 mm	1	Piece	-	L	488307
1000 mm	20 mm	2 mm	1	Piece	-	L	488321
1000 mm	25 mm	2 mm	1	Piece	-	L	488345
1000 mm	30 mm	2 mm	1	Piece	-	L	488369
2000 mm	15 mm	2 mm	1	Piece	-	L	488314
2000 mm	20 mm	2 mm	1	Piece	-	L	488338
2000 mm	25 mm	2 mm	1	Piece	-	L	488352
2000 mm	30 mm	2 mm	1	Piece	-	L	488376

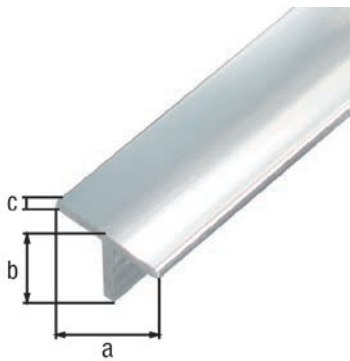

T profile

Length	Dimension a	Dimension b	Dimension c	UNIT	PU	Contents per PU	Deliv-ery time	Order no. 4004338...
Material: aluminium, Surface: chrome design								
2000 mm	15 mm	15 mm	15 mm	1	Piece	-	L	488451

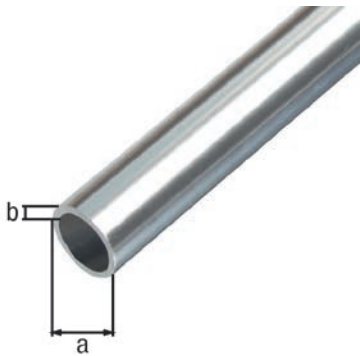

Round tube

Length	Dimension a-Ø	Dimension b	UNIT	PU	Contents per PU	Deliv-ery time	Order no. 4004338...
Material: aluminium, Surface: chrome design							
1000 mm	8 mm	1 mm	1	Piece	-	L	488383
1000 mm	15 mm	1 mm	1	Piece	-	L	488420
2000 mm	8 mm	1 mm	1	Piece	-	L	488390
2000 mm	15 mm	1 mm	1	Piece	-	L	488437

Angle profile, self-adhesive

Type: equal sided, self-adhesive

Length	Dimension a	Dimension b	Dimension c	UNIT	PU	Contents per PU	Delivery time	Order no. 4004338...
Material: aluminium, Surface: chrome design								
1000 mm	10 mm	10 mm	1 mm	1	Piece	-	L	488505
1000 mm	20 mm	20 mm	1 mm	1	Piece	-	L	488529
1000 mm	25 mm	25 mm	1 mm	1	Piece	-	L	488543
1000 mm	30 mm	30 mm	1 mm	1	Piece	-	L	488567
2000 mm	10 mm	10 mm	1 mm	1	Piece	-	L	488512
2000 mm	20 mm	20 mm	1 mm	1	Piece	-	L	488536
2000 mm	25 mm	25 mm	1 mm	1	Piece	-	L	488550
2000 mm	30 mm	30 mm	1 mm	1	Piece	-	L	488574

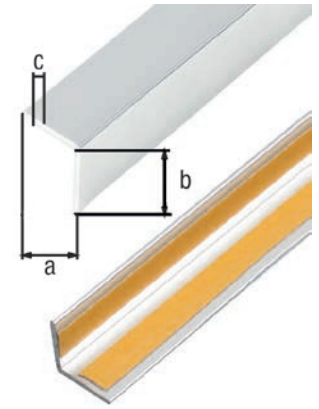

Angle profile, self-adhesive

Type: unequal sided, self-adhesive

Length	Dimension a	Dimension b	Dimension c	UNIT	PU	Contents per PU	Delivery time	Order no. 4004338...
Material: aluminium, Surface: chrome design								
1000 mm	15 mm	10 mm	1.0 mm	1	Piece	-	L	488581
1000 mm	20 mm	10 mm	1.0 mm	1	Piece	-	L	488604
1000 mm	25 mm	15 mm	1.5 mm	1	Piece	-	L	488628
1000 mm	30 mm	15 mm	1.5 mm	1	Piece	-	L	488642
2000 mm	15 mm	10 mm	1.0 mm	1	Piece	-	L	488598
2000 mm	20 mm	10 mm	1.0 mm	1	Piece	-	L	488611
2000 mm	25 mm	15 mm	1.5 mm	1	Piece	-	L	488635
2000 mm	30 mm	15 mm	1.5 mm	1	Piece	-	L	488659

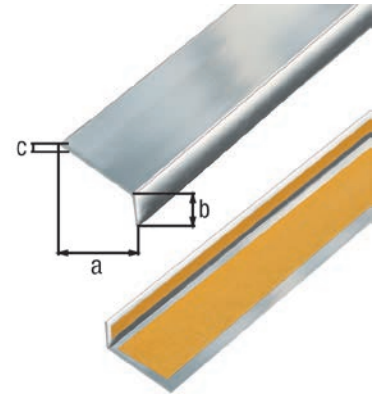

U profile

Length	Dimension a	Dimension b	Dimension c	Dimension d	UNIT	PU	Contents per PU	Delivery time	Order no. 4004338...
Material: aluminium, Surface: chrome design									
1000 mm	10 mm	15 mm	1 mm	8 mm	1	Piece	-	L	488482
2000 mm	10 mm	15 mm	1 mm	8 mm	1	Piece	-	L	488499

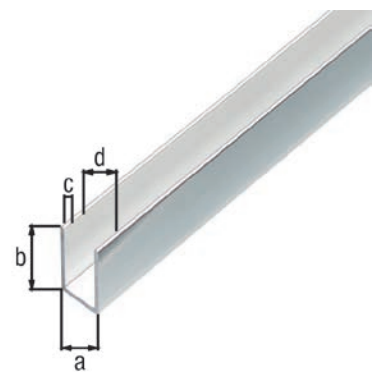

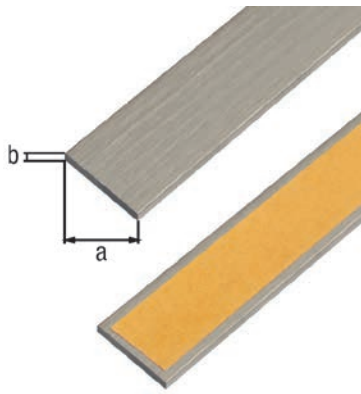

Flat bar, self-adhesive

Length: 1000 mm

Dimension a	Dimension b	UNIT	PU	Contents per PU	Deliv-ery time	Order no.
Material: aluminium, Surface: stainless steel design, dark						
15 mm	2 mm	1	Piece	-	L	488666
20 mm	2 mm	1	Piece	-	L	488673
25 mm	2 mm	1	Piece	-	L	488680

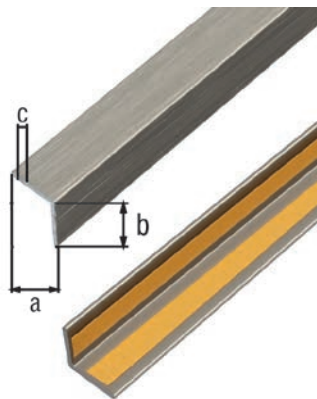

Angle profile, self-adhesive

Type: equal sided, self-adhesive
Length: 1000 mm

Dimension a	Dimension b	Dimension c	UNIT	PU	Contents per PU	Deliv-ery time	Order no.
Material: aluminium, Surface: stainless steel design, dark							
10 mm	10 mm	1 mm	1	Piece	-	L	488727
15 mm	15 mm	1 mm	1	Piece	-	L	488734
20 mm	20 mm	1 mm	1	Piece	-	L	488741

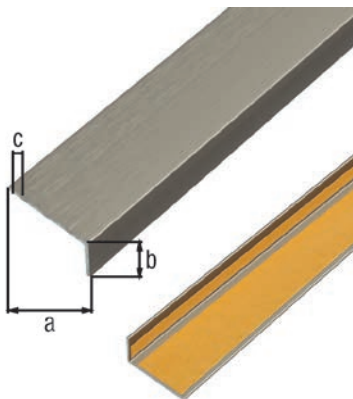

Angle profile, self-adhesive

Type: unequal sided, self-adhesive
Length: 1000 mm

Dimension a	Dimension b	Dimension c	UNIT	PU	Contents per PU	Deliv-ery time	Order no.
Material: aluminium, Surface: stainless steel design, dark							
20 mm	10 mm	1 mm	1	Piece	-	L	488758

Flat bar, self-adhesive

Length	Dimension a	Dimension b	UNIT	PU	Contents per PU	Delivery time	Order no. 4004338...
Material: aluminium, Surface: stainless steel design, light							
1000 mm	15 mm	2 mm	1	Piece	-	L	488765
1000 mm	20 mm	2 mm	1	Piece	-	L	488789
1000 mm	25 mm	2 mm	1	Piece	-	L	488802
1000 mm	30 mm	2 mm	1	Piece	-	L	488826
2000 mm	15 mm	2 mm	1	Piece	-	L	488772
2000 mm	20 mm	2 mm	1	Piece	-	L	488796
2000 mm	25 mm	2 mm	1	Piece	-	L	488819
2000 mm	30 mm	2 mm	1	Piece	-	L	488833

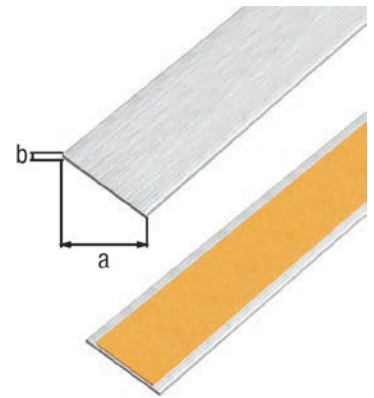

T profile

Length	Dimension a	Dimension b	Dimension c	UNIT	PU	Contents per PU	Delivery time	Order no. 4004338...
Material: aluminium, Surface: stainless steel design, light								
1000 mm	15 mm	15 mm	1.5 mm	1	Piece	-	L	488925
2000 mm	15 mm	15 mm	1.5 mm	1	Piece	-	L	488932

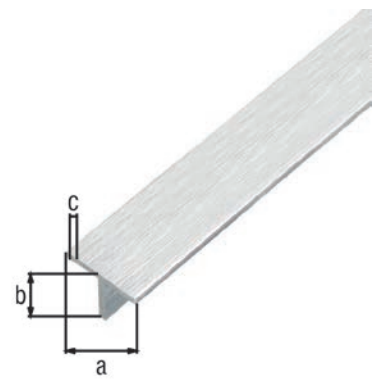

Round tube

Length	Dimension a-Ø	Dimension b	UNIT	PU	Contents per PU	Delivery time	Order no. 4004338...
Material: aluminium, Surface: stainless steel design, light							
1000 mm	8 mm	1 mm	1	Piece	-	L	488864
1000 mm	10 mm	1 mm	1	Piece	-	L	488888
2000 mm	8 mm	1 mm	1	Piece	-	L	488871
2000 mm	10 mm	1 mm	1	Piece	-	L	488895

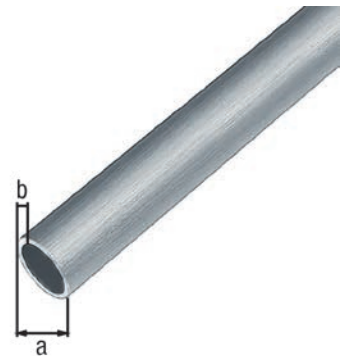

Rectangular tube

Length	Dimension a	Dimension b	Dimension c	UNIT	PU	Contents per PU	Delivery time	Order no. 4004338...
Material: aluminium, Surface: stainless steel design, light								
1000 mm	20 mm	10 mm	1 mm	1	Piece	-	L	488840
2000 mm	20 mm	10 mm	1 mm	1	Piece	-	L	488857

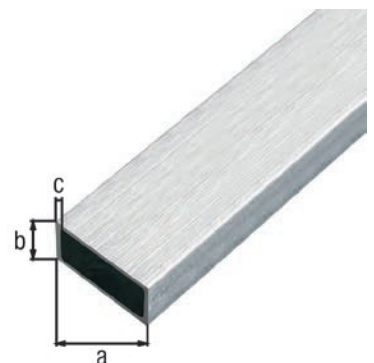

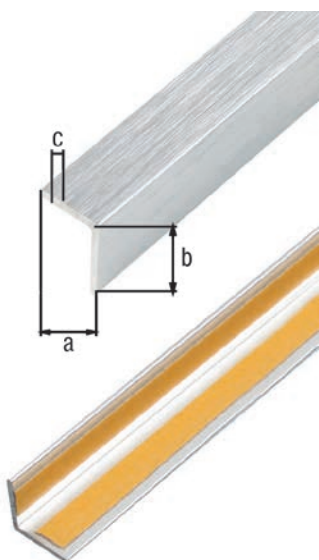

Angle profile, self-adhesive

Type: equal sided, self-adhesive

Length	Dimension a	Dimension b	Dimension c	UNIT	PU	Contents per PU	Deliv-ery time	Order no. 4004338...
Material: aluminium, Surface: stainless steel design, light								
1000 mm	10 mm	10 mm	1 mm	1	Piece	-	L	488987
1000 mm	15 mm	15 mm	1 mm	1	Piece	-	L	489007
1000 mm	20 mm	20 mm	1 mm	1	Piece	-	L	489021
1000 mm	25 mm	25 mm	1 mm	1	Piece	-	L	489045
1000 mm	30 mm	30 mm	1 mm	1	Piece	-	L	489069
2000 mm	10 mm	10 mm	1 mm	1	Piece	-	L	488994
2000 mm	15 mm	15 mm	1 mm	1	Piece	-	L	489014
2000 mm	20 mm	20 mm	1 mm	1	Piece	-	L	489038
2000 mm	25 mm	25 mm	1 mm	1	Piece	-	L	489052
2000 mm	30 mm	30 mm	1 mm	1	Piece	-	L	489076

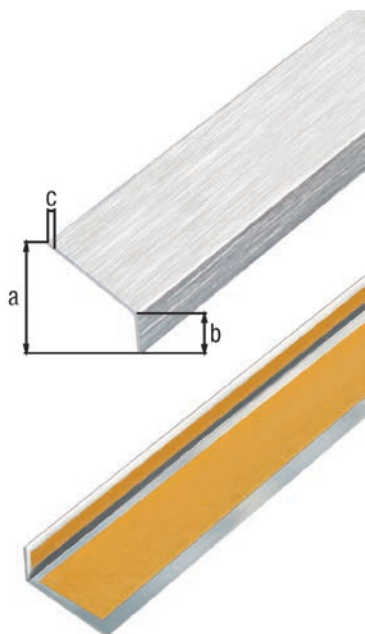

Angle profile, self-adhesive

Type: unequal sided, self-adhesive

Length	Dimension a	Dimension b	Dimension c	UNIT	PU	Contents per PU	Deliv-ery time	Order no. 4004338...
Material: aluminium, Surface: stainless steel design, light								
1000 mm	15 mm	10 mm	1.0 mm	1	Piece	-	L	489083
1000 mm	20 mm	10 mm	1.0 mm	1	Piece	-	L	489106
1000 mm	25 mm	15 mm	1.5 mm	1	Piece	-	L	489120
1000 mm	30 mm	15 mm	1.5 mm	1	Piece	-	L	489144
2000 mm	15 mm	10 mm	1.0 mm	1	Piece	-	L	489090
2000 mm	20 mm	10 mm	1.0 mm	1	Piece	-	L	489113
2000 mm	25 mm	15 mm	1.5 mm	1	Piece	-	L	489137
2000 mm	30 mm	15 mm	1.5 mm	1	Piece	-	L	489151

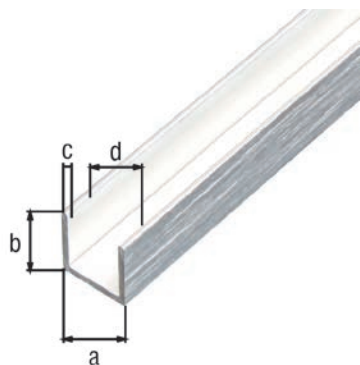

U profile

Length	Dimension a	Dimension b	Dimension c	Dimension d	UNIT	PU	Contents per PU	Deliv-ery time	Order no. 4004338...
Material: aluminium, Surface: stainless steel design, light									
1000 mm	10 mm	10 mm	1 mm	8 mm	1	Piece	-	L	488949
1000 mm	10 mm	15 mm	1 mm	8 mm	1	Piece	-	L	488963
2000 mm	10 mm	10 mm	1 mm	8 mm	1	Piece	-	L	488956
2000 mm	10 mm	15 mm	1 mm	8 mm	1	Piece	-	L	488970

Flat bar, self-adhesive

Length: 1000 mm

Dimension a	Dimension b	UNIT	PU	Contents per PU	Deliv-ery time	Order no. 4004338...
Material: aluminium, Surface: shot blasted, silver colour						
15 mm	2 mm	1	Piece	-	L	489168
20 mm	2 mm	1	Piece	-	L	489175

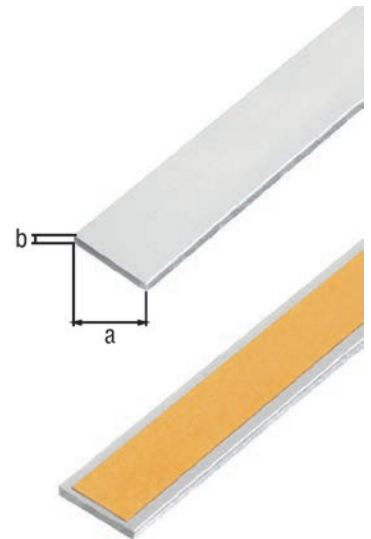

Round tube

Length: 1000 mm

Dimension a-Ø	Dimension b	UNIT	PU	Contents per PU	Deliv-ery time	Order no. 4004338...
Material: aluminium, Surface: shot blasted, silver colour						
10 mm	1 mm	1	Piece	-	L	489205



Angle profile, self-adhesive

Type: equal sided, self-adhesive

Length: 1000 mm

Dimension a	Dimension b	Dimension c	UNIT	PU	Contents per PU	Deliv-ery time	Order no. 4004338...
Material: aluminium, Surface: shot blasted, silver colour							
10 mm	10 mm	1 mm	1	Piece	-	L	489229
15 mm	15 mm	1 mm	1	Piece	-	L	489236
20 mm	20 mm	1 mm	1	Piece	-	L	489243

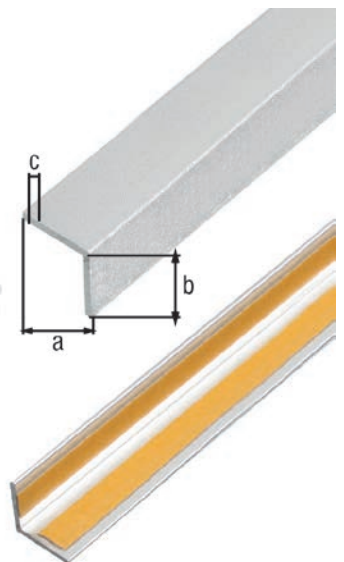

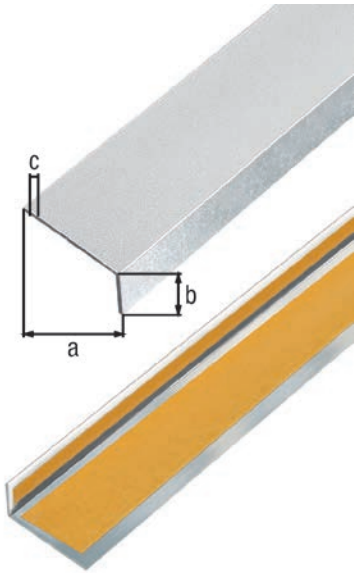

Angle profile, self-adhesive

Type: unequal sided, self-adhesive
 Length: 1000 mm

Dimension a	Dimension b	Dimension c	UNIT	PU	Contents per PU	Deliv-ery time	Order no.
Material: aluminium, Surface: shot blasted, silver colour							
20 mm	10 mm	1 mm	1	Piece	-	L	489250

CONNECTOR CLAMP PROFILES

Made to last.

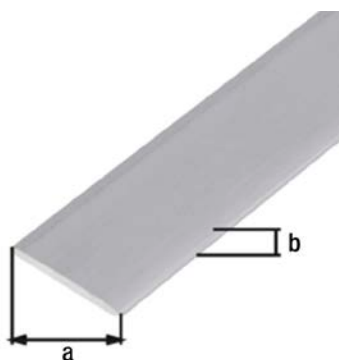

Flat bar

Length	Dimension a	Dimension b	UNIT	PU	Contents per PU	Deliv-ery time	Order no.
Material: aluminium, Surface: silver anodised							
1000 mm	14.5 mm	1.5 mm	1	Piece	-	L	473297
2000 mm	14.5 mm	1.5 mm	1	Piece	-	L	473303
Material: aluminium, Surface: anthracite powder-coated RAL 7016							
1000 mm	14.5 mm	1.5 mm	1	Piece	-	L	434755
2000 mm	14.5 mm	1.5 mm	1	Piece	-	L	434762

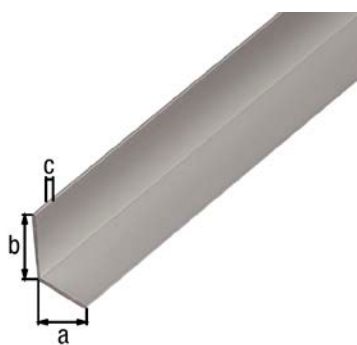

Angle profile

designed to protect and decorate the edges of furniture or home-assembled shelves the sides with unequal leg lengths each cover two different material thicknesses

- Clean assembly and covering for cut edges

Length	Dimension a	Dimension b	Dimension c	For plate thickness	UNIT	PU	Contents per PU	Deliv-ery time	Order no.
Material: aluminium, Surface: silver anodised									
1000 mm	9.5 mm	7.5 mm	1.5 mm	6 - 8 mm	1	Piece	-	L	029993
1000 mm	14.5 mm	11.5 mm	1.3 mm	10 - 13 mm	1	Piece	-	L	030401
1000 mm	19.8 mm	17.8 mm	1.5 mm	16 - 18 mm	1	Piece	-	L	030685
1000 mm	22.8 mm	19.0 mm	1.5 mm	17.5 - 21 mm	1	Piece	-	L	030869
2000 mm	9.5 mm	7.5 mm	1.5 mm	6 - 8 mm	1	Piece	-	L	030005
2000 mm	14.5 mm	11.5 mm	1.3 mm	10 - 13 mm	1	Piece	-	L	030494
2000 mm	19.8 mm	17.8 mm	1.5 mm	16 - 18 mm	1	Piece	-	L	030692
2000 mm	22.8 mm	19.0 mm	1.5 mm	17.5 - 21 mm	1	Piece	-	L	030876

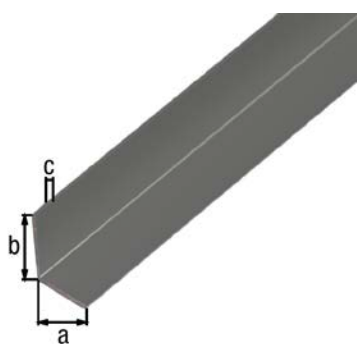

Angle profile

designed to protect and decorate the edges of furniture or home-assembled shelves the sides with unequal leg lengths each cover two different material thicknesses

- Clean assembly and covering for cut edges

Length	Dimension a	Dimension b	Dimension c	For plate thickness	UNIT	PU	Contents per PU	Deliv-ery time	Order no.
Material: aluminium, Surface: anthracite powder-coated RAL 7016									
1000 mm	14.5 mm	11.5 mm	1.3 mm	10 mm	1	Piece	-	L	434779
2000 mm	14.5 mm	11.5 mm	1.3 mm	10 mm	1	Piece	-	L	434786
1000 mm	20 mm	20.0 mm	1.0 mm	19 mm	1	Piece	-	L	434793
2000 mm	20 mm	20.0 mm	1.0 mm	19 mm	1	Piece	-	L	434809
1000 mm	25 mm	25.0 mm	1.0 mm	24 mm	1	Piece	-	L	434816
2000 mm	25 mm	25.0 mm	1.0 mm	24 mm	1	Piece	-	L	434823
1000 mm	30 mm	30.0 mm	1.3 mm	28.5 mm	1	Piece	-	L	434830
2000 mm	30 mm	30.0 mm	1.3 mm	28.5 mm	1	Piece	-	L	434847

U profile, self-adhesive

designed to protect and decorate the edges of wooden or plastic panels by sliding on or attaching perfectly fitting profiles

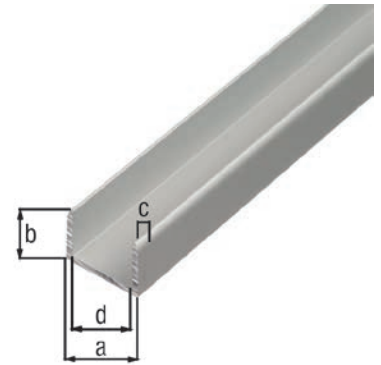

Length	Dimension a	Dimension b	Dimension c	Dimension d	UNIT	PU	Contents per PU	Delivery time	Order no. 4003122...
Material: aluminium, Surface: silver anodised									
1000 mm	8.9 mm	10 mm	1.5 mm	5.9 mm	1	Piece	-	L	030104
1000 mm	10.9 mm	10 mm	1.5 mm	7.9 mm	1	Piece	-	L	030166
1000 mm	12.9 mm	10 mm	1.5 mm	9.9 mm	1	Piece	-	L	030500
1000 mm	15.9 mm	15 mm	1.5 mm	12.9 mm	1	Piece	-	L	030623
1000 mm	19.9 mm	15 mm	2.0 mm	15.9 mm	1	Piece	-	L	030708
1000 mm	22.5 mm	22 mm	1.8 mm	18.9 mm	1	Piece	-	L	030883
1000 mm	24.6 mm	24 mm	1.8 mm	21.0 mm	1	Piece	-	L	030920
2000 mm	8.9 mm	10 mm	1.5 mm	5.9 mm	1	Piece	-	L	030111
2000 mm	10.9 mm	10 mm	1.5 mm	7.9 mm	1	Piece	-	L	030173
2000 mm	12.9 mm	10 mm	1.5 mm	9.9 mm	1	Piece	-	L	030531
2000 mm	15.9 mm	15 mm	1.5 mm	12.9 mm	1	Piece	-	L	030630
2000 mm	19.9 mm	15 mm	2.0 mm	15.9 mm	1	Piece	-	L	030807
2000 mm	22.5 mm	22 mm	1.8 mm	18.9 mm	1	Piece	-	L	030890
2000 mm	24.6 mm	24 mm	1.8 mm	21.0 mm	1	Piece	-	L	030937

H profile, self-adhesive

for connecting several panels to create larger surfaces (wall and ceiling cladding, work surfaces, etc.)

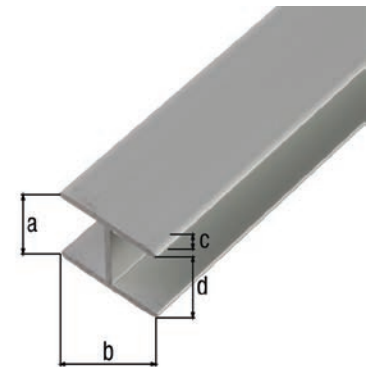

Length	Dimension a	Dimension b	Dimension c	Dimension d	UNIT	PU	Contents per PU	Delivery time	Order no. 4003122...
Material: aluminium, Surface: silver anodised									
1000 mm	8.9 mm	20 mm	1.5 mm	5.9 mm	1	Piece	-	L	030128
1000 mm	10.9 mm	20 mm	1.5 mm	7.9 mm	1	Piece	-	L	030180
1000 mm	12.9 mm	22 mm	1.5 mm	9.9 mm	1	Piece	-	L	030548
1000 mm	15.9 mm	24 mm	1.5 mm	12.9 mm	1	Piece	-	L	030647
1000 mm	19.5 mm	30 mm	1.8 mm	15.9 mm	1	Piece	-	L	030814
2000 mm	8.9 mm	20 mm	1.5 mm	5.9 mm	1	Piece	-	L	030135
2000 mm	10.9 mm	20 mm	1.5 mm	7.9 mm	1	Piece	-	L	030197
2000 mm	12.9 mm	22 mm	1.5 mm	9.9 mm	1	Piece	-	L	030593
2000 mm	15.9 mm	24 mm	1.5 mm	12.9 mm	1	Piece	-	L	030654
2000 mm	19.5 mm	30 mm	1.8 mm	15.9 mm	1	Piece	-	L	030838

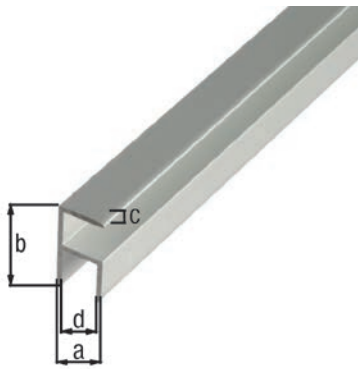

Corner profile, self-adhesive

for right-angled connection of several panels

Length	Dimension a	Dimension b	Dimension c	Dimension d	UNIT	PU	Contents per PU	Deliv-ery time	Order no. 4003122...
Material: aluminium, Surface: silver anodised									
1000 mm	8.9 mm	16.3 mm	1.5 mm	5.9 mm	1	Piece	-	L	030142
1000 mm	10.9 mm	20 mm	1.5 mm	7.9 mm	1	Piece	-	L	030203
1000 mm	12.9 mm	24 mm	1.5 mm	9.9 mm	1	Piece	-	L	030609
1000 mm	15.9 mm	30 mm	1.5 mm	12.9 mm	1	Piece	-	L	030661
1000 mm	19.5 mm	37 mm	1.8 mm	15.9 mm	1	Piece	-	L	030845
1000 mm	22.5 mm	43 mm	1.8 mm	18.9 mm	1	Piece	-	L	030906
2000 mm	8.9 mm	16.3 mm	1.5 mm	5.9 mm	1	Piece	-	L	030159
2000 mm	10.9 mm	20 mm	1.5 mm	7.9 mm	1	Piece	-	L	030395
2000 mm	12.9 mm	24 mm	1.5 mm	9.9 mm	1	Piece	-	L	030616
2000 mm	15.9 mm	30 mm	1.5 mm	12.9 mm	1	Piece	-	L	030678
2000 mm	19.5 mm	37 mm	1.8 mm	15.9 mm	1	Piece	-	L	030852
2000 mm	22.5 mm	43 mm	1.8 mm	18.9 mm	1	Piece	-	L	030913

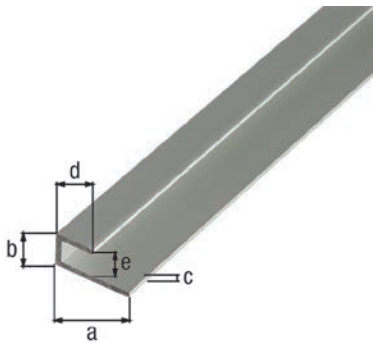

End profile, self-adhesive

Length	Dimension a	Dimension b	Dimension c	Dimension d	Dimension e	UNIT	PU	Contents per PU	Deliv-ery time	Order no. 4003122...
Material: aluminium, Surface: silver anodised										
1000 mm	20 mm	9 mm	1.5 mm	10 mm	6 mm	1	Piece	-	L	030944
2000 mm	20 mm	9 mm	1.5 mm	10 mm	6 mm	1	Piece	-	L	030951

STEEL PROFILES

Made to last.

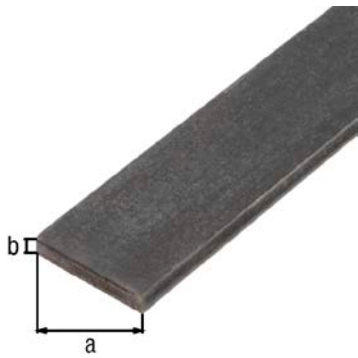

Flat bar

Length	Dimension a	Dimension b	UNIT	PU	Contents per PU	Deliv-ery time	Order no. 4004338...
Material: raw steel, hot rolled							
1000 mm	10 mm	4 mm	1	Piece	-	L	432577
1000 mm	15 mm	5 mm	1	Piece	-	L	432584
1000 mm	20 mm	4 mm	1	Piece	-	L	432591
1000 mm	25 mm	4 mm	1	Piece	-	L	432607
1000 mm	30 mm	6 mm	1	Piece	-	L	432614
1000 mm	35 mm	6 mm	1	Piece	-	L	433376
2000 mm	10 mm	4 mm	1	Piece	-	L	432560
2000 mm	15 mm	5 mm	1	Piece	-	L	430160
2000 mm	20 mm	4 mm	1	Piece	-	L	430085
2000 mm	25 mm	4 mm	1	Piece	-	L	432041
2000 mm	30 mm	6 mm	1	Piece	-	L	430122
2000 mm	40 mm	6 mm	1	Piece	-	L	431501

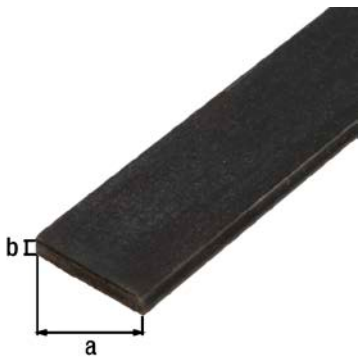

Flat bar

Length: 1000 mm

Length	Dimension a	Dimension b	UNIT	PU	Contents per PU	Deliv-ery time	Order no. 4004338...
Material: raw steel, cold rolled							
1000 mm	10 mm	2 mm	1	Piece	-	L	433284
1000 mm	16 mm	2 mm	1	Piece	-	L	433253
1000 mm	20 mm	2 mm	1	Piece	-	L	433277
1000 mm	25 mm	2 mm	1	Piece	-	L	433291
1000 mm	30 mm	2 mm	1	Piece	-	L	433314

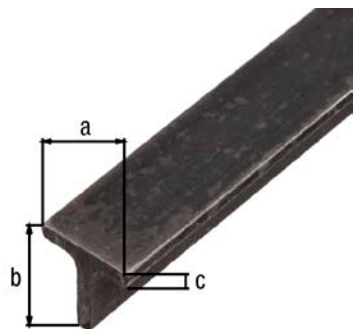

T profile

Length	Dimension a	Dimension b	Dimension c	UNIT	PU	Contents per PU	Deliv-ery time	Order no. 4004338...
Material: raw steel, hot rolled								
1000 mm	20 mm	20 mm	3.0 mm	1	Piece	-	L	432836
2000 mm	20 mm	20 mm	3.0 mm	1	Piece	-	L	430368
2000 mm	25 mm	25 mm	3.5 mm	1	Piece	-	L	430405

Round bar

Length	Dimension a-Ø	UNIT	PU	Contents per PU	Deliv-ery time	Order no. 4004338...
Material: raw steel, hot rolled						
1000 mm	6 mm	1	Piece	-	L	432676
1000 mm	8 mm	1	Piece	-	L	432683
1000 mm	10 mm	1	Piece	-	L	432690
1000 mm	12 mm	1	Piece	-	L	432706
2000 mm	6 mm	1	Piece	-	L	432669
2000 mm	8 mm	1	Piece	-	L	430689
2000 mm	10 mm	1	Piece	-	L	430726
2000 mm	12 mm	1	Piece	-	L	430764



Round bar

Length: 1000 mm

Length	Dimension a-Ø	UNIT	PU	Contents per PU	Deliv-ery time	Order no. 4004338...
Material: raw steel, drawn						
1000 mm	4 mm	1	Piece	-	L	433246
1000 mm	8 mm	1	Piece	-	L	433307

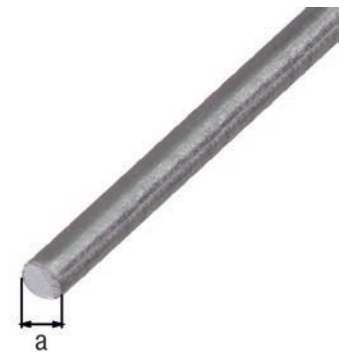

Steel bar for concrete

Length	Dimension a-Ø	UNIT	PU	Contents per PU	Deliv-ery time	Order no. 4004338...
Material: raw steel, hot rolled, for setting in concrete						
1000 mm	6 mm	1	Piece	-	L	431815
1000 mm	8 mm	1	Piece	-	L	430306
1000 mm	10 mm	1	Piece	-	L	430320
1000 mm	12 mm	1	Piece	-	L	430344
2000 mm	6 mm	1	Piece	-	L	475451
2000 mm	8 mm	1	Piece	-	L	475468
2000 mm	10 mm	1	Piece	-	L	475475
2000 mm	12 mm	1	Piece	-	L	475482

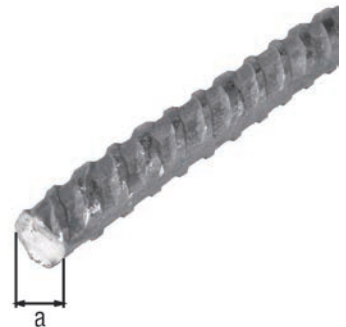



Round tube

Length	Dimension a-Ø	Dimension b	UNIT	PU	Contents per PU	Deliv-ery time	Order no. 4004338...
Material: raw steel, cold rolled							
1000 mm	12 mm	1.0 mm	1	Piece	-	L	432713
1000 mm	16 mm	1.0 mm	1	Piece	-	L	432720
1000 mm	20 mm	1.2 mm	1	Piece	-	L	433352
1000 mm	22 mm	1.2 mm	1	Piece	-	L	432737
2000 mm	12 mm	1.0 mm	1	Piece	-	L	431402
2000 mm	16 mm	1.0 mm	1	Piece	-	L	431440
2000 mm	22 mm	1.2 mm	1	Piece	-	L	431488

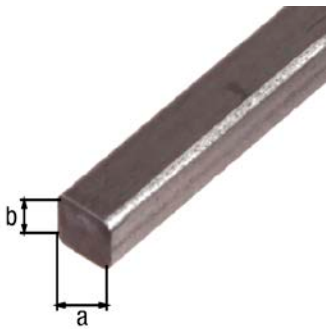

Square bar

Length	Dimension a	Dimension b	UNIT	PU	Contents per PU	Deliv-ery time	Order no. 4004338...
Material: raw steel, hot rolled							
1000 mm	6 mm	6 mm	1	Piece	-	L	432409
1000 mm	10 mm	10 mm	1	Piece	-	L	432423
1000 mm	12 mm	12 mm	1	Piece	-	L	432430
2000 mm	6 mm	6 mm	1	Piece	-	L	430443
2000 mm	8 mm	8 mm	1	Piece	-	L	430481
2000 mm	10 mm	10 mm	1	Piece	-	L	430528
2000 mm	12 mm	12 mm	1	Piece	-	L	430566
2000 mm	14 mm	14 mm	1	Piece	-	L	433406

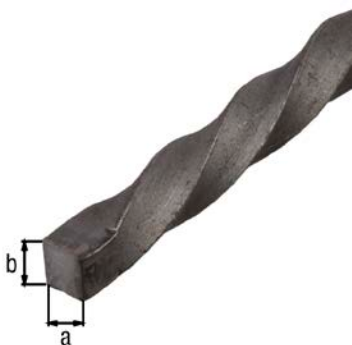

Square bar, twisted

Length	Dimension a	Dimension b	UNIT	PU	Contents per PU	Deliv-ery time	Order no. 4004338...
Material: raw steel, hot rolled							
1000 mm	8 mm	8 mm	1	Piece	-	L	432461
1000 mm	10 mm	10 mm	1	Piece	-	L	432485
1000 mm	12 mm	12 mm	1	Piece	-	L	432492
2000 mm	8 mm	8 mm	1	Piece	-	L	431280
2000 mm	12 mm	12 mm	1	Piece	-	L	431327
2000 mm	14 mm	14 mm	1	Piece	-	L	431365

Square tube

Length	Dimension a	Dimension b	Dimension c	UNIT	PU	Contents per PU	Delivery time	Order no. 4004338...
Material: raw steel, cold rolled								
1000 mm	16 mm	16 mm	1.0 mm	1	Piece	-	L	432515
1000 mm	20 mm	20 mm	1.5 mm	1	Piece	-	L	432522
1000 mm	25 mm	25 mm	1.5 mm	1	Piece	-	L	432539
1000 mm	30 mm	30 mm	1.5 mm	1	Piece	-	L	432546
2000 mm	12 mm	12 mm	1.0 mm	1	Piece	-	L	431525
2000 mm	16 mm	16 mm	1.0 mm	1	Piece	-	L	431563
2000 mm	20 mm	20 mm	1.5 mm	1	Piece	-	L	431600
2000 mm	25 mm	25 mm	1.5 mm	1	Piece	-	L	431648
2000 mm	30 mm	30 mm	1.5 mm	1	Piece	-	L	431761
2000 mm	40 mm	40 mm	1.5 mm	1	Piece	-	L	431723

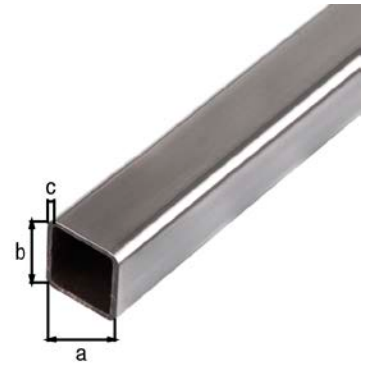

Rectangular tube

Length	Dimension a	Dimension b	Dimension c	UNIT	PU	Contents per PU	Delivery time	Order no. 4004338...
Material: raw steel, cold rolled								
1000 mm	40 mm	30 mm	1.5 mm	1	Piece	-	L	432553
2000 mm	40 mm	30 mm	1.5 mm	1	Piece	-	L	431686

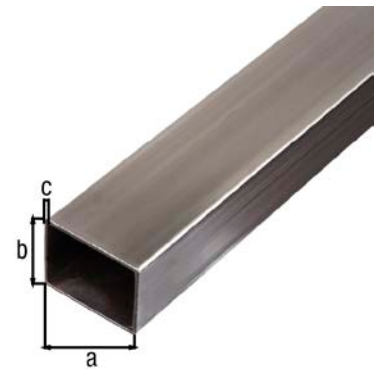

Angle profile

Type: equal sided

Length	Dimension a	Dimension b	Dimension c	UNIT	PU	Contents per PU	Delivery time	Order no. 4004338...
Material: raw steel, cold rolled								
1000 mm	15 mm	15 mm	1.2 mm	1	Piece	-	L	432775
1000 mm	20 mm	20 mm	1.2 mm	1	Piece	-	L	432799
1000 mm	20 mm	20 mm	3.0 mm	1	Piece	-	L	432805
1000 mm	25 mm	25 mm	1.2 mm	1	Piece	-	L	432812
1000 mm	25 mm	25 mm	3.0 mm	1	Piece	-	L	432829
1000 mm	30 mm	30 mm	3.0 mm	1	Piece	-	L	433383
2000 mm	15 mm	15 mm	1.2 mm	1	Piece	-	L	432768
2000 mm	20 mm	20 mm	1.2 mm	1	Piece	-	L	432782
2000 mm	20 mm	20 mm	2.0 mm	1	Piece	-	L	431884
2000 mm	20 mm	20 mm	3.0 mm	1	Piece	-	L	432126
2000 mm	25 mm	25 mm	1.2 mm	1	Piece	-	L	431921
2000 mm	25 mm	25 mm	3.0 mm	1	Piece	-	L	432164
2000 mm	30 mm	30 mm	3.0 mm	1	Piece	-	L	475499

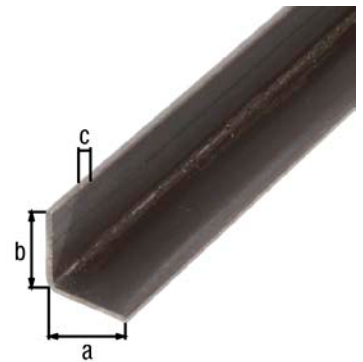

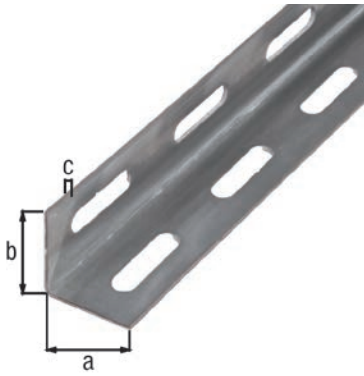

Angle profile, perforated

Type: equal sided

Length	Dimension a	Dimension b	Dimension c	UNIT	PU	Contents per PU	Deliv-ery time	Order no. 4004338...
Material: raw steel, Surface: hot-dip galvanised								
1000 mm	27 mm	27 mm	1.5 mm	1	Piece	-	L	432942
2000 mm	27 mm	27 mm	1.5 mm	1	Piece	-	L	432997
Material: raw steel, Surface: zinc phosphate plated, white powder-coated								
1000 mm	27 mm	27 mm	1.5 mm	1	Piece	-	L	432102
2000 mm	27 mm	27 mm	1.5 mm	1	Piece	-	L	432379

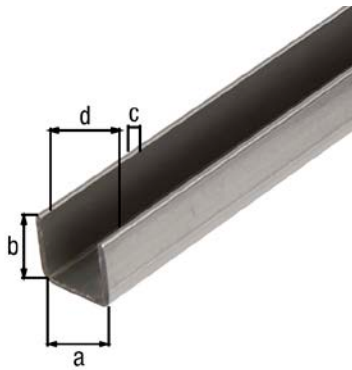

U profile

Length	Dimension a	Dimension b	Dimension c	Dimension d	UNIT	PU	Contents per PU	Deliv-ery time	Order no. 4004338...
Material: raw steel, cold rolled									
1000 mm	20 mm	20 mm	1.5 mm	17 mm	1	Piece	-	L	432843
2000 mm	20 mm	20 mm	1.5 mm	17 mm	1	Piece	-	L	432003

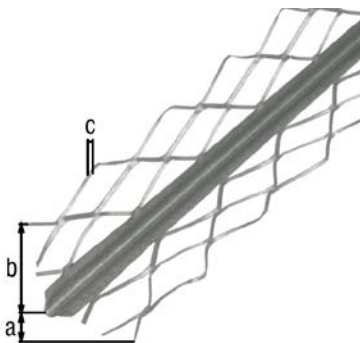

Edge protection profile

Length: 2600 mm

Dimension a	Dimension b	Dimension c	UNIT	PU	Contents per PU	Deliv-ery time	Order no. 4004338...
Material: raw steel, Surface: hot-dip galvanised							
32 mm	32 mm	2.5 mm	1	Piece	-	L	469856

Conceptor® Flat bar, perforated

Length	Dimension a	Dimension b	UNIT	PU	Contents per PU	Deliv-ery time	Order no. 4004338...
Material: raw steel, Surface: sendzimir galvanised							
1000 mm	35 mm	1.5 mm	1	Piece	-	L	432133
2000 mm	35 mm	1.5 mm	1	Piece	-	L	432171
Material: raw steel, Surface: sendzimir galvanised, white powder-coated RAL 9016							
1000 mm	35 mm	1.5 mm	1	Piece	-	L	433765
2000 mm	35 mm	1.5 mm	1	Piece	-	L	433772

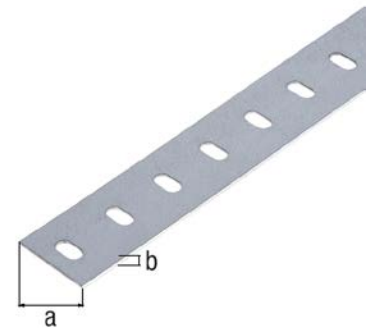

Conceptor® Angle profile, perforated

Type: equal sided

Length	Dimension a	Dimension b	Dimension c	UNIT	PU	Contents per PU	Deliv-ery time	Order no. 4004338...
Material: raw steel, Surface: sendzimir galvanised								
1000 mm	15 mm	15 mm	1.0 mm	1	Piece	-	L	431983
1000 mm	25 mm	25 mm	1.2 mm	1	Piece	-	L	432010
1000 mm	35 mm	35 mm	1.5 mm	1	Piece	-	L	432140
2000 mm	15 mm	15 mm	1.0 mm	1	Piece	-	L	431990
2000 mm	25 mm	25 mm	1.2 mm	1	Piece	-	L	432027
2000 mm	35 mm	35 mm	1.5 mm	1	Piece	-	L	432188
Material: raw steel, Surface: sendzimir galvanised, white powder-coated RAL 9016								
1000 mm	15 mm	15 mm	1.0 mm	1	Piece	-	L	433840
1000 mm	25 mm	25 mm	1.2 mm	1	Piece	-	L	433864
1000 mm	35 mm	35 mm	1.5 mm	1	Piece	-	L	433789
2000 mm	15 mm	15 mm	1.0 mm	1	Piece	-	L	433857
2000 mm	25 mm	25 mm	1.2 mm	1	Piece	-	L	433871
2000 mm	35 mm	35 mm	1.5 mm	1	Piece	-	L	433796

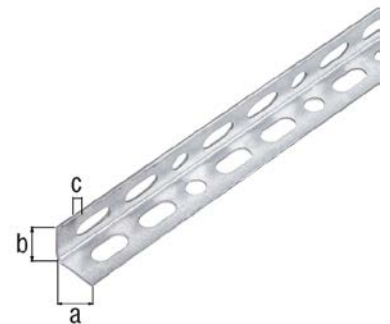

Conceptor® Angle profile, perforated

Type: unequal sided

Length	Dimension a	Dimension b	Dimension c	UNIT	PU	Contents per PU	Deliv-ery time	Order no. 4004338...
Material: raw steel, Surface: sendzimir galvanised								
1000 mm	25 mm	45 mm	1.5 mm	1	Piece	-	L	431976
1000 mm	60 mm	35 mm	1.5 mm	1	Piece	-	L	432157
2000 mm	25 mm	45 mm	1.5 mm	1	Piece	-	L	431952
2000 mm	60 mm	35 mm	1.5 mm	1	Piece	-	L	432195
Material: raw steel, Surface: sendzimir galvanised, white powder-coated RAL 9016								
1000 mm	25 mm	45 mm	1.5 mm	1	Piece	-	L	433888
1000 mm	60 mm	35 mm	1.5 mm	1	Piece	-	L	433802
2000 mm	25 mm	45 mm	1.5 mm	1	Piece	-	L	433895
2000 mm	60 mm	35 mm	1.5 mm	1	Piece	-	L	433819

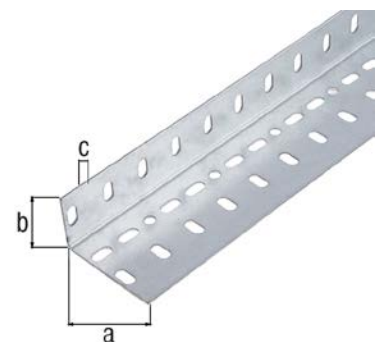



Conceptor® Accessory kit for profile system

Set components: One set consists of pan head screws M6x10mm, nuts and washers

UNIT	PU	Contents per PU	Delivery time	Order no. 4004338...
Material: raw steel, Surface: blue galvanised				
4	Blister	25 Piece	L	430313
4	Blister	50 Piece	L	430337

STAINLESS STEEL PROFILES

Made to last.

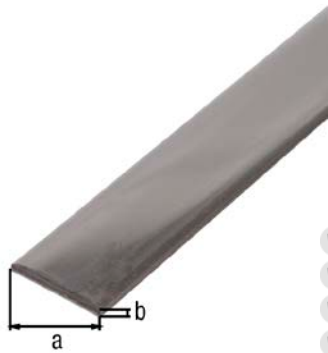

Flat bar

	Length	Dimension a	Dimension b	UNIT	PU	Contents per PU	Deliv-ery time	Order no. 4004338...
Material: stainless steel								
VA	1000 mm	15 mm	2 mm	1	Piece	-	L	485337
VA	1000 mm	20 mm	2 mm	1	Piece	-	L	485344
VA	1000 mm	25 mm	2 mm	1	Piece	-	L	485351
VA	1000 mm	30 mm	3 mm	1	Piece	-	L	485368
VA	2000 mm	15 mm	2 mm	1	Piece	-	L	485542
VA	2000 mm	20 mm	2 mm	1	Piece	-	L	485559
VA	2000 mm	25 mm	2 mm	1	Piece	-	L	485566
VA	2000 mm	30 mm	3 mm	1	Piece	-	L	485573



Round bar

	Length	Dimension a-Ø	UNIT	PU	Contents per PU	Deliv-ery time	Order no. 4004338...
Material: stainless steel							
VA	1000 mm	6 mm	1	Piece	-	L	485504
VA	1000 mm	7 mm	1	Piece	-	L	485511
VA	2000 mm	6 mm	1	Piece	-	L	485580
VA	2000 mm	8 mm	1	Piece	-	L	485597



Round tube

	Length	Dimension a-Ø	Dimension b	UNIT	PU	Contents per PU	Deliv-ery time	Order no. 4004338...
Material: stainless steel								
VA	1000 mm	8 mm	1 mm	1	Piece	-	L	485382
VA	1000 mm	10 mm	1 mm	1	Piece	-	L	485399
VA	1000 mm	12 mm	1 mm	1	Piece	-	L	485405
VA	1000 mm	18 mm	1 mm	1	Piece	-	L	487294
VA	2000 mm	8 mm	1 mm	1	Piece	-	L	487263
VA	2000 mm	10 mm	1 mm	1	Piece	-	L	487270
VA	2000 mm	12 mm	1 mm	1	Piece	-	L	487287
VA	2000 mm	18 mm	1 mm	1	Piece	-	L	487300

Square tube

Length	Dimension a	Dimension b	Dimension c	UNIT	PU	Contents per PU	Delivery time	Order no. 4004338...
Material: stainless steel								
1000 mm	10 mm	10 mm	1.0 mm	1	Piece	-	L	485429 VA
1000 mm	15 mm	15 mm	1.5 mm	1	Piece	-	L	485436 VA
1000 mm	20 mm	20 mm	1.5 mm	1	Piece	-	L	485443 VA
1000 mm	30 mm	30 mm	2.0 mm	1	Piece	-	L	487362 VA
2000 mm	10 mm	10 mm	1.0 mm	1	Piece	-	L	487331 VA
2000 mm	15 mm	15 mm	1.5 mm	1	Piece	-	L	487348 VA
2000 mm	20 mm	20 mm	1.5 mm	1	Piece	-	L	487355 VA
2000 mm	30 mm	30 mm	2.0 mm	1	Piece	-	L	487379 VA

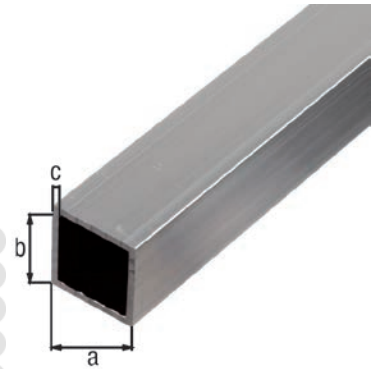

Angle profile

Type: equal sided

Length	Dimension a	Dimension b	Dimension c	UNIT	PU	Contents per PU	Delivery time	Order no. 4004338...
Material: stainless steel								
1000 mm	10 mm	10 mm	1.0 mm	1	Piece	-	L	485450 VA
1000 mm	15 mm	15 mm	1.5 mm	1	Piece	-	L	485467 VA
1000 mm	20 mm	20 mm	1.5 mm	1	Piece	-	L	485474 VA
2000 mm	10 mm	10 mm	1.0 mm	1	Piece	-	L	487409 VA
2000 mm	15 mm	15 mm	1.5 mm	1	Piece	-	L	487416 VA
2000 mm	20 mm	20 mm	1.5 mm	1	Piece	-	L	487423 VA

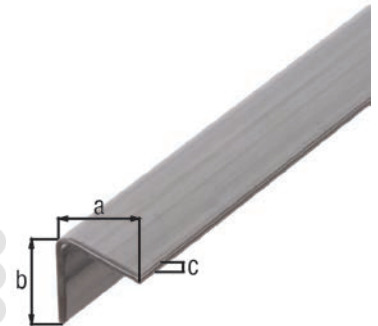

Angle profile

Type: unequal sided

Length	Dimension a	Dimension b	Dimension c	UNIT	PU	Contents per PU	Delivery time	Order no. 4004338...
Material: stainless steel								
1000 mm	20 mm	10 mm	1.5 mm	1	Piece	-	L	485481 VA
1000 mm	25 mm	15 mm	1.5 mm	1	Piece	-	L	485498 VA
2000 mm	20 mm	10 mm	1.5 mm	1	Piece	-	L	487430 VA
2000 mm	25 mm	15 mm	1.5 mm	1	Piece	-	L	487447 VA

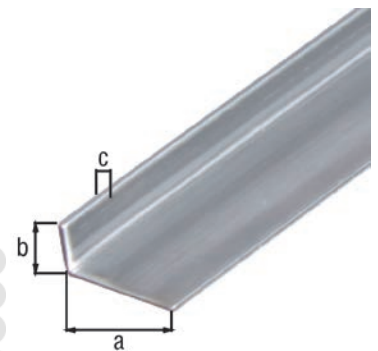

U profile

Length	Dimension a	Dimension b	Dimension c	Dimension d	UNIT	PU	Contents per PU	Delivery time	Order no. 4004338...
Material: stainless steel									
1000 mm	16 mm	10 mm	1.5 mm	13 mm	1	Piece	-	L	485313 VA
1000 mm	20 mm	10 mm	1.5 mm	17 mm	1	Piece	-	L	485306 VA
2000 mm	16 mm	10 mm	1.5 mm	13 mm	1	Piece	-	L	487454 VA
2000 mm	20 mm	10 mm	1.5 mm	17 mm	1	Piece	-	L	487461 VA

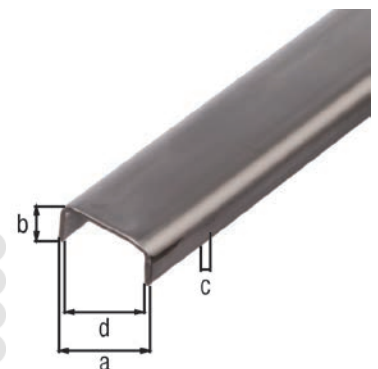

BRASS PROFILES

Made to last.

Flat bar

Length: 1000 mm

Dimension a	Dimension b	UNIT	PU	Contents per PU	Delivery time	Order no. 4004338...
Material: brass						
7 mm	2.5 mm	1	Piece	-	L	471316
10 mm	2.0 mm	1	Piece	-	L	471323
15 mm	2.0 mm	1	Piece	-	L	471330
20 mm	2.0 mm	1	Piece	-	L	470937

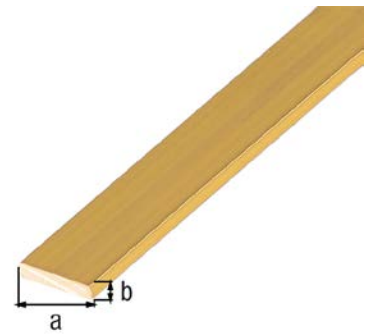

Round bar

Length: 1000 mm

Dimension a-Ø	UNIT	PU	Contents per PU	Delivery time	Order no. 4004338...
Material: brass					
4 mm	1	Piece	-	L	471118
6 mm	1	Piece	-	L	471125
8 mm	1	Piece	-	L	471132
10 mm	1	Piece	-	L	471149

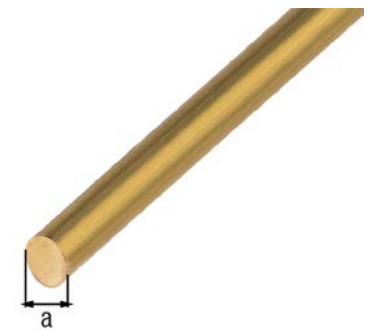

Round tube

Length: 1000 mm

Dimension a-Ø	Dimension b	UNIT	PU	Contents per PU	Delivery time	Order no. 4004338...
Material: brass						
2 mm	0.3 mm	1	Piece	-	L	471217
4 mm	0.5 mm	1	Piece	-	L	471224
6 mm	0.5 mm	1	Piece	-	L	471231
8 mm	0.5 mm	1	Piece	-	L	471248
10 mm	1.0 mm	1	Piece	-	L	471255

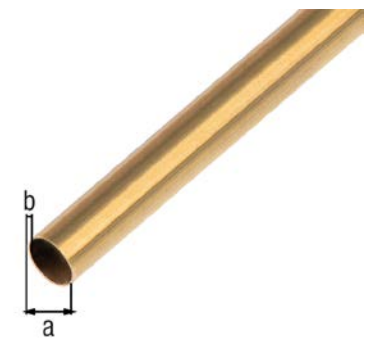

Square bar

Length: 1000 mm

Dimension a	Dimension b	UNIT	PU	Contents per PU	Delivery time	Order no. 4004338...
Material: brass						
6 mm	6 mm	1	Piece	-	L	471019

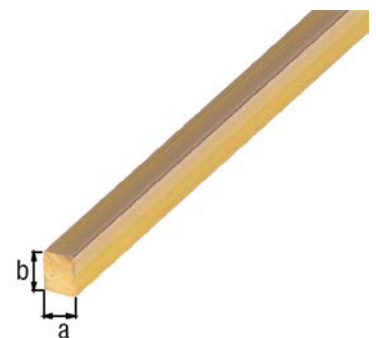

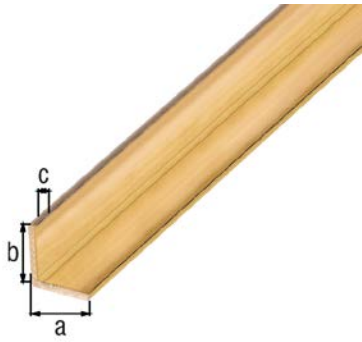

Angle profile

Type: equal sided
Length: 1000 mm

Dimension a	Dimension b	Dimension c	UNIT	PU	Contents per PU	Deliv-ery time	Order no. 4004338...
Material: brass							
6 mm	6 mm	0.8 mm	1	Piece	-	L	470944
10 mm	10 mm	1.0 mm	1	Piece	-	L	470968
15 mm	15 mm	1.5 mm	1	Piece	-	L	471446
20 mm	20 mm	1.5 mm	1	Piece	-	L	471453

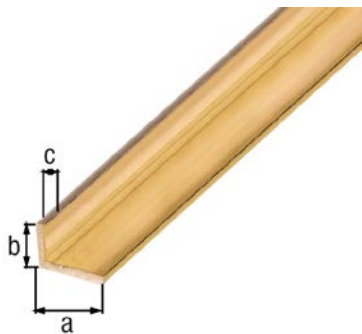

Angle profile

Type: unequal sided
Length: 1000 mm

Dimension a	Dimension b	Dimension c	UNIT	PU	Contents per PU	Deliv-ery time	Order no. 4004338...
Material: brass							
12 mm	10 mm	1.0 mm	1	Piece	-	L	470999
20 mm	10 mm	1.5 mm	1	Piece	-	L	471538
20 mm	15 mm	1.5 mm	1	Piece	-	L	471002
30 mm	15 mm	1.5 mm	1	Piece	-	L	471545

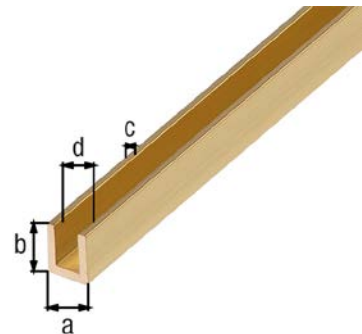

U profile

Length: 1000 mm

Dimension a	Dimension b	Dimension c	Dimension d	UNIT	PU	Contents per PU	Deliv-ery time	Order no. 4004338...
Material: brass								
6 mm	6 mm	1 mm	4 mm	1	Piece	-	L	471613

PLASTIC PROFILES

Made to last.

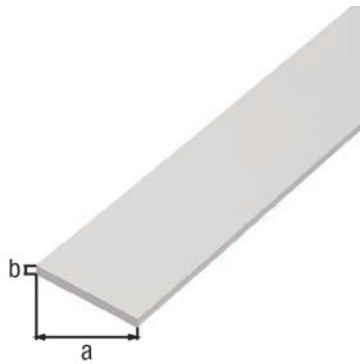

Flat bar

Length	Dimension a	Dimension b	UNIT	PU	Contents per PU	Deliv-ery time	Order no. 4004338...
Material: PVC-U, colour: white							
1000 mm	20 mm	2 mm	1	Piece	-	L	479381
1000 mm	25 mm	2 mm	1	Piece	-	L	479404
1000 mm	30 mm	3 mm	1	Piece	-	L	479428
2000 mm	20 mm	2 mm	1	Piece	-	L	479398
2000 mm	25 mm	2 mm	1	Piece	-	L	479411
2000 mm	30 mm	3 mm	1	Piece	-	L	479435
2000 mm	40 mm	3 mm	1	Piece	-	L	477035
2000 mm	50 mm	3 mm	1	Piece	-	L	477042
2600 mm	20 mm	2 mm	1	Piece	-	L	470395
2600 mm	25 mm	2 mm	1	Piece	-	L	463274
2600 mm	30 mm	2 mm	1	Piece	-	L	492472
2600 mm	30 mm	3 mm	1	Piece	-	L	492205
2600 mm	50 mm	2 mm	1	Piece	-	L	492526
2600 mm	100 mm	2 mm	1	Piece	-	L	492557



Round tube

Length	Dimension a-Ø	Dimension b	UNIT	PU	Contents per PU	Deliv-ery time	Order no. 4004338...
Material: PVC-U, colour: white							
1000 mm	7 mm	1 mm	1	Piece	-	L	484910
1000 mm	10 mm	1 mm	1	Piece	-	L	484927
1000 mm	12 mm	1 mm	1	Piece	-	L	484934
2000 mm	7 mm	1 mm	1	Piece	-	L	484941
2000 mm	10 mm	1 mm	1	Piece	-	L	484958
2000 mm	12 mm	1 mm	1	Piece	-	L	484965
2600 mm	7 mm	1 mm	1	Piece	-	L	492533
2600 mm	10 mm	1 mm	1	Piece	-	L	488208
2600 mm	12 mm	1 mm	1	Piece	-	L	468972
Material: PVC-U, colour: black							
1000 mm	7 mm	1 mm	1	Piece	-	L	484972
1000 mm	10 mm	1 mm	1	Piece	-	L	484989
1000 mm	12 mm	1 mm	1	Piece	-	L	484996

Angle profile

Type: equal sided

Length	Dimension a	Dimension b	Dimension c	UNIT	PU	Contents per PU	Deliv-ery time	Order no. 4004338...
Material: PVC-U, colour: white								
1000 mm	7 mm	7 mm	1.0 mm	1	Piece	-	L	470579
1000 mm	10 mm	10 mm	1.0 mm	1	Piece	-	L	479206
1000 mm	15 mm	15 mm	1.2 mm	1	Piece	-	L	479213
1000 mm	20 mm	20 mm	1.5 mm	1	Piece	-	L	479237
1000 mm	25 mm	25 mm	1.8 mm	1	Piece	-	L	479251
1000 mm	30 mm	30 mm	2.0 mm	1	Piece	-	L	485054
1000 mm	50 mm	50 mm	1.2 mm	1	Piece	-	L	485832
2000 mm	10 mm	10 mm	1.0 mm	1	Piece	-	L	479305
2000 mm	15 mm	15 mm	1.2 mm	1	Piece	-	L	479312
2000 mm	20 mm	20 mm	1.5 mm	1	Piece	-	L	479336
2000 mm	25 mm	25 mm	1.8 mm	1	Piece	-	L	479350
2000 mm	30 mm	30 mm	2.0 mm	1	Piece	-	L	485061
2000 mm	50 mm	50 mm	1.2 mm	1	Piece	-	L	485818
2000 mm	60 mm	60 mm	2.0 mm	1	Piece	-	L	477004
2000 mm	80 mm	80 mm	2.0 mm	1	Piece	-	L	477011
2000 mm	100 mm	100 mm	2.0 mm	1	Piece	-	L	477028
2600 mm	10 mm	10 mm	1.0 mm	1	Piece	-	L	433451
2600 mm	15 mm	15 mm	1.2 mm	1	Piece	-	L	478759
2600 mm	20 mm	20 mm	1.5 mm	1	Piece	-	L	478766
2600 mm	25 mm	25 mm	1.5 mm	1	Piece	-	L	475673
2600 mm	30 mm	30 mm	1.1 mm	1	Piece	-	L	433475
2600 mm	35 mm	35 mm	1.1 mm	1	Piece	-	L	433482
2600 mm	40 mm	40 mm	1.2 mm	1	Piece	-	L	475598
2600 mm	50 mm	50 mm	1.2 mm	1	Piece	-	L	489977
2600 mm	100 mm	100 mm	1.5 mm	1	Piece	-	L	492571
Material: PVC-U, colour: black								
1000 mm	10 mm	10 mm	1.0 mm	1	Piece	-	L	479008
1000 mm	15 mm	15 mm	1.2 mm	1	Piece	-	L	479015
1000 mm	20 mm	20 mm	1.5 mm	1	Piece	-	L	479039
1000 mm	25 mm	25 mm	1.8 mm	1	Piece	-	L	479053
1000 mm	30 mm	30 mm	2.0 mm	1	Piece	-	L	485078
2000 mm	10 mm	10 mm	1.0 mm	1	Piece	-	L	479107
2000 mm	15 mm	15 mm	1.2 mm	1	Piece	-	L	479114
2000 mm	20 mm	20 mm	1.5 mm	1	Piece	-	L	479138
2000 mm	25 mm	25 mm	1.8 mm	1	Piece	-	L	479152
2000 mm	30 mm	30 mm	2.0 mm	1	Piece	-	L	485085
2600 mm	10 mm	10 mm	1.0 mm	1	Piece	-	L	470500
2600 mm	15 mm	15 mm	1.2 mm	1	Piece	-	L	492489
2600 mm	20 mm	20 mm	1.0 mm	1	Piece	-	L	433468
2600 mm	25 mm	25 mm	1.8 mm	1	Piece	-	L	470043
2600 mm	30 mm	30 mm	2.0 mm	1	Piece	-	L	499815
Material: PVC-U, colour: silver-aluminium grey								
1000 mm	10 mm	10 mm	1.0 mm	1	Piece	-	L	470593
1000 mm	15 mm	15 mm	1.0 mm	1	Piece	-	L	470609
1000 mm	20 mm	20 mm	1.0 mm	1	Piece	-	L	485030
2600 mm	20 mm	20 mm	1.0 mm	1	Piece	-	L	485047
Material: PVC-U, colour: transparent								
1000 mm	20 mm	20 mm	1.0 mm	1	Piece	-	L	485092
2600 mm	20 mm	20 mm	1.0 mm	1	Piece	-	L	485108

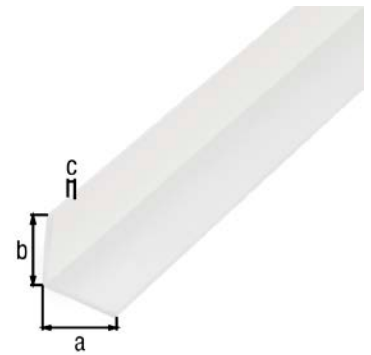

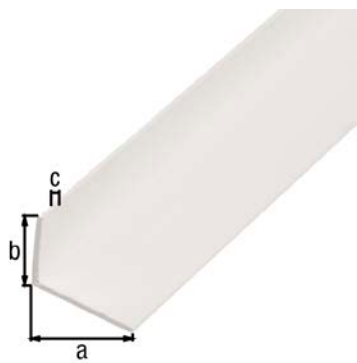

Angle profile

Type: unequal sided

Length	Dimension a	Dimension b	Dimension c	UNIT	PU	Contents per PU	Deliv-ery time	Order no. 4004338...
Material: PVC-U, colour: white								
1000 mm	20 mm	10 mm	1.5 mm	1	Piece	-	L	479220
1000 mm	25 mm	15 mm	1.0 mm	1	Piece	-	L	485856
1000 mm	25 mm	20 mm	2.0 mm	1	Piece	-	L	479244
1000 mm	30 mm	20 mm	3.0 mm	1	Piece	-	L	479268
1000 mm	40 mm	10 mm	2.0 mm	1	Piece	-	L	479275
2000 mm	20 mm	10 mm	1.5 mm	1	Piece	-	L	479329
2000 mm	25 mm	20 mm	2.0 mm	1	Piece	-	L	479343
2000 mm	30 mm	20 mm	3.0 mm	1	Piece	-	L	479367
2000 mm	40 mm	10 mm	2.0 mm	1	Piece	-	L	479374
2600 mm	20 mm	10 mm	1.5 mm	1	Piece	-	L	470265
2600 mm	25 mm	20 mm	2.0 mm	1	Piece	-	L	465872
2600 mm	30 mm	20 mm	1.0 mm	1	Piece	-	L	433499
2600 mm	40 mm	10 mm	2.0 mm	1	Piece	-	L	488093
Material: PVC-U, colour: black								
1000 mm	20 mm	10 mm	1.5 mm	1	Piece	-	L	479022
1000 mm	25 mm	20 mm	2.0 mm	1	Piece	-	L	479046
1000 mm	30 mm	20 mm	3.0 mm	1	Piece	-	L	479060
1000 mm	40 mm	10 mm	2.0 mm	1	Piece	-	L	479077
2000 mm	20 mm	10 mm	1.5 mm	1	Piece	-	L	479121
2000 mm	25 mm	20 mm	2.0 mm	1	Piece	-	L	479145
2000 mm	30 mm	20 mm	3.0 mm	1	Piece	-	L	479169
2000 mm	40 mm	10 mm	2.0 mm	1	Piece	-	L	479176
2600 mm	20 mm	10 mm	1.5 mm	1	Piece	-	L	499839
2600 mm	25 mm	20 mm	2.0 mm	1	Piece	-	L	465889
2600 mm	30 mm	20 mm	3.0 mm	1	Piece	-	L	487898
2600 mm	40 mm	10 mm	2.0 mm	1	Piece	-	L	499853
Material: PVC-U, colour: silver-aluminium grey								
1000 mm	25 mm	15 mm	1.0 mm	1	Piece	-	L	484668
2600 mm	25 mm	15 mm	1.0 mm	1	Piece	-	L	484675

Angle profile

Type: equal sided

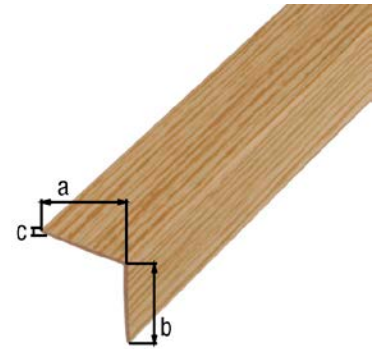

Length	Dimension a	Dimension b	Dimension c	UNIT	PU	Contents per PU	Deliv-ery time	Order no. 4004338...
Material: PVC-U, colour: decorative oak								
1000 mm	20 mm	20 mm	1.5 mm	1	Piece	-	L	478698
2000 mm	20 mm	20 mm	1.5 mm	1	Piece	-	L	478728
2600 mm	20 mm	20 mm	1.5 mm	1	Piece	-	L	465421
Material: PVC-U, colour: decorative oak, dark								
1000 mm	20 mm	20 mm	1.5 mm	1	Piece	-	L	478704
2000 mm	20 mm	20 mm	1.5 mm	1	Piece	-	L	478735
2600 mm	20 mm	20 mm	1.5 mm	1	Piece	-	L	489991
Material: PVC-U, colour: decorative beech								
1000 mm	20 mm	20 mm	1.5 mm	1	Piece	-	L	478711
2000 mm	20 mm	20 mm	1.5 mm	1	Piece	-	L	478742
2600 mm	20 mm	20 mm	1.0 mm	1	Piece	-	L	478773
Material: PVC-U, colour: decorative beech, dark								
2600 mm	20 mm	20 mm	1.0 mm	1	Piece	-	L	478780

U profile

Length	Dimension a	Dimension b	Dimension c	Dimension d	UNIT	PU	Contents per PU	Deliv-ery time	Order no. 4004338...
Material: PVC-U, colour: white									
1000 mm	8.7 mm	6.2 mm	1.2 mm	6.3 mm	1	Piece	-	L	470562
1000 mm	10 mm	10 mm	1 mm	8 mm	1	Piece	-	L	484507
1000 mm	12 mm	10 mm	1 mm	10 mm	1	Piece	-	L	484514
1000 mm	18 mm	10 mm	1 mm	16 mm	1	Piece	-	L	484521
1000 mm	21 mm	10 mm	1 mm	19 mm	1	Piece	-	L	484538
1000 mm	21 mm	20 mm	1 mm	19 mm	1	Piece	-	L	484545
2000 mm	10 mm	10 mm	1 mm	8 mm	1	Piece	-	L	484552
2000 mm	12 mm	10 mm	1 mm	10 mm	1	Piece	-	L	484569
2000 mm	18 mm	10 mm	1 mm	16 mm	1	Piece	-	L	484576
2000 mm	21 mm	10 mm	1 mm	19 mm	1	Piece	-	L	484583
2000 mm	21 mm	20 mm	1 mm	19 mm	1	Piece	-	L	484590
2600 mm	10 mm	10 mm	1 mm	8 mm	1	Piece	-	L	488215
2600 mm	12 mm	10 mm	1 mm	10 mm	1	Piece	-	L	432058
2600 mm	14 mm	10 mm	1 mm	12 mm	1	Piece	-	L	432065
2600 mm	18 mm	10 mm	1 mm	16 mm	1	Piece	-	L	432072
2600 mm	21 mm	10 mm	1 mm	19 mm	1	Piece	-	L	432089
2600 mm	21 mm	20 mm	1 mm	19 mm	1	Piece	-	L	492588
Material: PVC-U, colour: black									
1000 mm	18 mm	10 mm	1 mm	16 mm	1	Piece	-	L	484606
2600 mm	21 mm	10 mm	1 mm	19 mm	1	Piece	-	L	432096

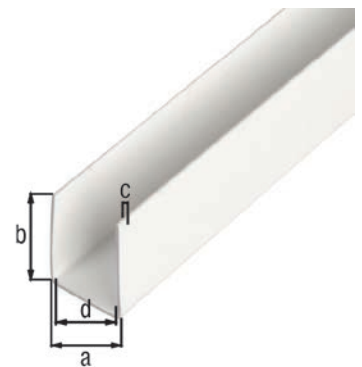

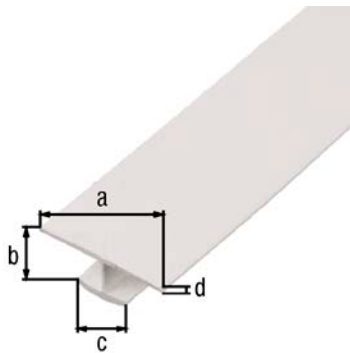

H profile

Length	Dimension a	Dimension b	Dimension c	Dimension d	UNIT	PU	Contents per PU	Deliv-ery time	Order no. 4004338...
Material: PVC-U, colour: white									
1000 mm	25 mm	4 mm	12 mm	1.0 mm	1	Piece	-	L	484699
1000 mm	25 mm	6 mm	10 mm	1.0 mm	1	Piece	-	L	484705
1000 mm	45 mm	20 mm	30 mm	1.0 mm	1	Piece	-	L	484682
2000 mm	25 mm	4 mm	12 mm	1.0 mm	1	Piece	-	L	484729
2000 mm	25 mm	6 mm	10 mm	1.0 mm	1	Piece	-	L	484736
2600 mm	25 mm	4 mm	12 mm	1.0 mm	1	Piece	-	L	470203
2600 mm	25 mm	6 mm	10 mm	1.0 mm	1	Piece	-	L	470401

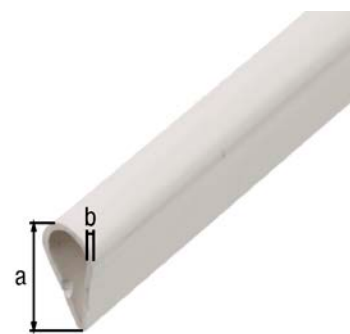

Clamping profile

max. clamping range: 3 mm

Length	Dimension a	Dimension b	UNIT	PU	Contents per PU	Deliv-ery time	Order no. 4004338...
Material: PVC-U, colour: white							
1000 mm	15 mm	0.9 mm	1	Piece	-	L	484859
2000 mm	15 mm	0.9 mm	1	Piece	-	L	484866
Material: PVC-U, colour: black							
1000 mm	15 mm	0.9 mm	1	Piece	-	L	484873
2000 mm	15 mm	0.9 mm	1	Piece	-	L	484880
Material: PVC-U, colour: transparent							
1000 mm	15 mm	0.9 mm	1	Piece	-	L	484897

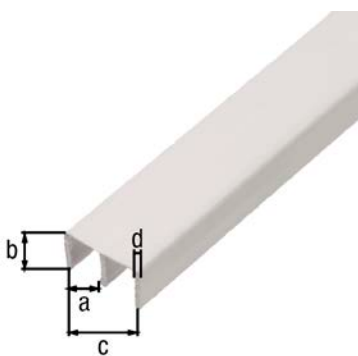

Guide rail profile, top

Length	Dimension a	Dimension b	Dimension c	Dimension d	UNIT	PU	Contents per PU	Deliv-ery time	Order no. 4004338...
Material: PVC-U, colour: white									
1000 mm	6.5 mm	10 mm	16 mm	1.0 mm	1	Piece	-	L	485115
2000 mm	6.5 mm	10 mm	16 mm	1.0 mm	1	Piece	-	L	485122
Material: PVC-U, colour: black									
1000 mm	6.5 mm	10 mm	16 mm	1.0 mm	1	Piece	-	L	485139
2000 mm	6.5 mm	10 mm	16 mm	1.0 mm	1	Piece	-	L	485146

Guide rail profile, bottom

Length	Dimension a	Dimension b	Dimension c	Dimension d	UNIT	PU	Contents per PU	Delivery time	Order no. 4004338...
Material: PVC-U, colour: white									
1000 mm	6.5 mm	5 mm	16 mm	1.0 mm	1	Piece	-	L	485153
2000 mm	6.5 mm	5 mm	16 mm	1.0 mm	1	Piece	-	L	485160
Material: PVC-U, colour: black									
1000 mm	6.5 mm	5 mm	16 mm	1.0 mm	1	Piece	-	L	485177
2000 mm	6.5 mm	5 mm	16 mm	1.0 mm	1	Piece	-	L	485184

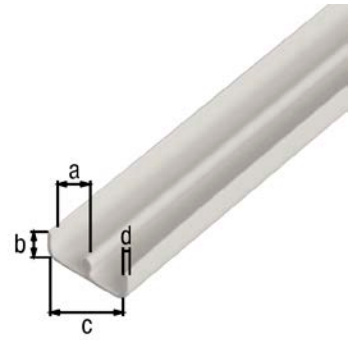

Quarter circle profile

Material thickness: 1.20 mm

Length	Dimension a	UNIT	PU	Contents per PU	Delivery time	Order no. 4004338...
Material: PVC-U, colour: stainless steel finish						
1000 mm	15 mm	1	Piece	-	L	485207
2600 mm	15 mm	1	Piece	-	L	485214
Material: PVC-U, colour: white						
1000 mm	15 mm	1	Piece	-	L	485221
2600 mm	15 mm	1	Piece	-	L	485238



T profile

Length	Dimension a	Dimension b	Dimension c	UNIT	PU	Contents per PU	Delivery time	Order no. 4004338...
Material: PVC-U, colour: white								
1000 mm	25 mm	18 mm	2 mm	1	Piece	-	L	485269
2600 mm	25 mm	18 mm	2 mm	1	Piece	-	L	485276

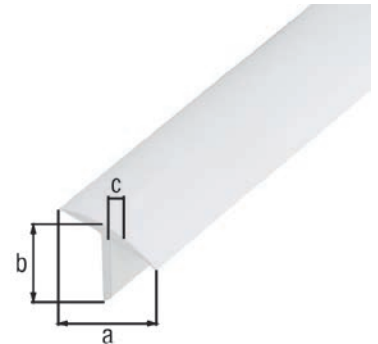

End profile

Length: 1000 mm

Dimension a	Dimension b	Dimension c	Dimension d	UNIT	PU	Contents per PU	Delivery time	Order no. 4004338...
Material: PVC-U, colour: white								
15 mm	6 mm	1 mm	10 mm	1	Piece	-	L	470548
Material: PVC-U, colour: decorative oak								
15 mm	6 mm	1 mm	10 mm	1	Piece	-	L	470555

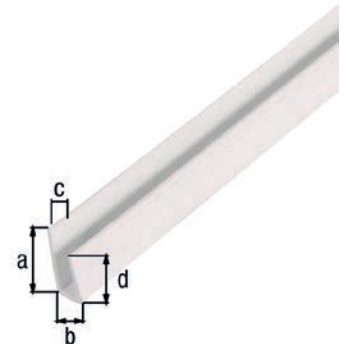



Edge profile

Length: 1000 mm
Material thickness: 0.50 mm

Dimension a	Dimension b	UNIT	PU	Contents per PU	Deliv-ery time	Order no. 4004338...
Material: PVC-U, colour: black						
7 mm	4 mm	1	Piece	-	L	470586

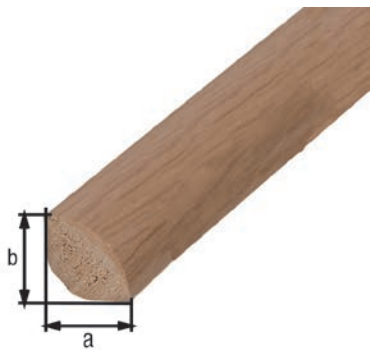

Quarter circle profile

Length: 2600 mm

Dimension a	Dimension b	UNIT	PU	Contents per PU	Deliv-ery time	Order no. 4004338...
Material: PVC-U, foamed, colour: oak, dark						
15 mm	15 mm	1	Piece	-	L	433932
Material: PVC-U, foamed, colour: white						
15 mm	15 mm	1	Piece	-	L	433949
Material: PVC-U, foamed, colour: beech						
15 mm	15 mm	1	Piece	-	L	433956

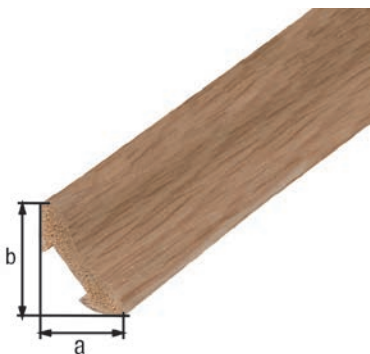

Skirting profile

Length: 2600 mm

Dimension a	Dimension b	UNIT	PU	Contents per PU	Deliv-ery time	Order no. 4004338...
Material: PVC-U, foamed, colour: oak, dark						
22 mm	22 mm	1	Piece	-	L	433970
Material: PVC-U, foamed, colour: white						
22 mm	22 mm	1	Piece	-	L	433963
Material: PVC-U, foamed, colour: beech						
22 mm	22 mm	1	Piece	-	L	433987

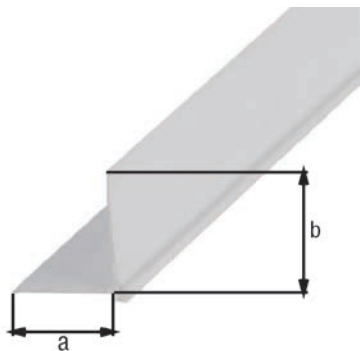

Wallpaper corner profile

Length: 2600 mm
Material thickness: 1.00 mm

Dimension a	Dimension b	UNIT	PU	Contents per PU	Deliv-ery time	Order no. 4004338...
Material: PVC-U, colour: white						
20 mm	20 mm	1	Piece	-	L	433994

Corner protection profile, rounded

Length: 2600 mm

Dimension a	Dimension b	UNIT	PU	Contents per PU	Deliv-ery time	Order no. 4004338...
Material: PVC-U, foamed, colour: white						
19 mm	19 mm	1	Piece	-	L	434069

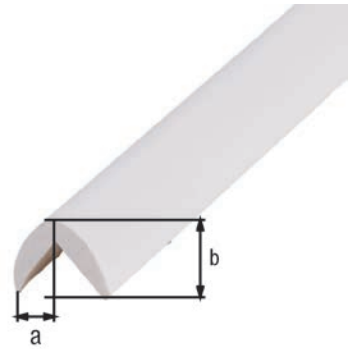

End profile, self-adhesive

Length: 2600 mm

Dimension a	Dimension b	UNIT	PU	Contents per PU	Deliv-ery time	Order no. 4004338...
Material: PVC-U with aluminium inlay, colour: silver						
15 mm	15 mm	1	Piece	-	L	433727
Material: PVC-U with aluminium inlay, colour: brushed stainless steel						
15 mm	15 mm	1	Piece	-	L	433734

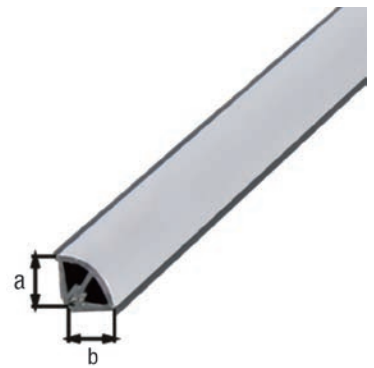

Accessory kit for end profiles

Set components: One set consists of four end caps, four inner corners 90°, two outer corners 90° and two inner corners 135°

UNIT	PU	Contents per PU	Delivery time	Order no. 4004338...
Material: PVC-U, colour: black				
10	Bag	1 Bag	L	433741



PROFILES, SELF-ADHESIVE

Made to last.

Flat bar, self-adhesive

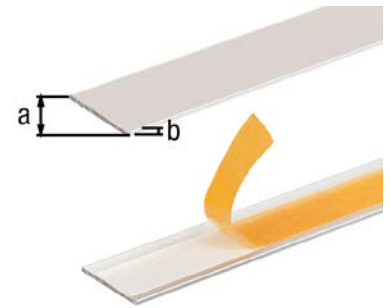

Length	Dimension a	Dimension b	UNIT	PU	Contents per PU	Deliv-ery time	Order no. 4004338...
Material: aluminium, Surface: silver anodised							
1000 mm	20 mm	2 mm	1	Piece	-	L	433635
1000 mm	30 mm	2 mm	1	Piece	-	L	433659
2600 mm	20 mm	2 mm	1	Piece	-	L	433642
2600 mm	30 mm	2 mm	1	Piece	-	L	433666

Angle profile, self-adhesive

Type: equal sided, self-adhesive

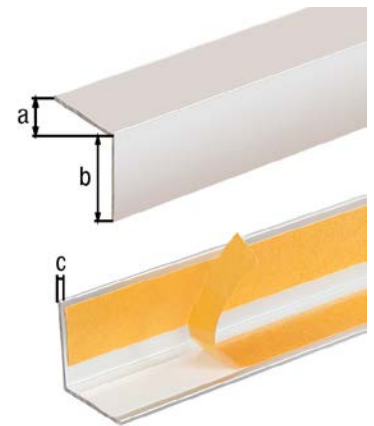

Length	Dimension a	Dimension b	Dimension c	UNIT	PU	Contents per PU	Deliv-ery time	Order no. 4004338...
Material: aluminium, Surface: silver anodised								
1000 mm	20 mm	20 mm	1.5 mm	1	Piece	-	L	433536
1000 mm	30 mm	30 mm	2.0 mm	1	Piece	-	L	433574
2600 mm	20 mm	20 mm	1.5 mm	1	Piece	-	L	433543
2600 mm	30 mm	30 mm	2.0 mm	1	Piece	-	L	433581

Flat bar, self-adhesive

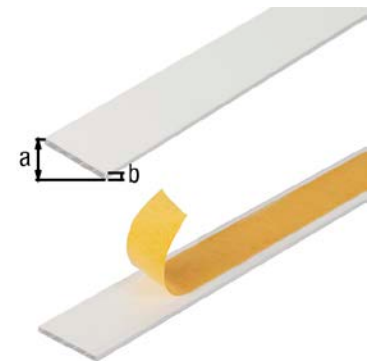

Length	Dimension a	Dimension b	UNIT	PU	Contents per PU	Deliv-ery time	Order no. 4004338...
Material: aluminium, Surface: white powder-coated RAL 9016							
1000 mm	20 mm	2 mm	1	Piece	-	L	433598
1000 mm	30 mm	2 mm	1	Piece	-	L	433611
2600 mm	20 mm	2 mm	1	Piece	-	L	433604
2600 mm	30 mm	2 mm	1	Piece	-	L	433628

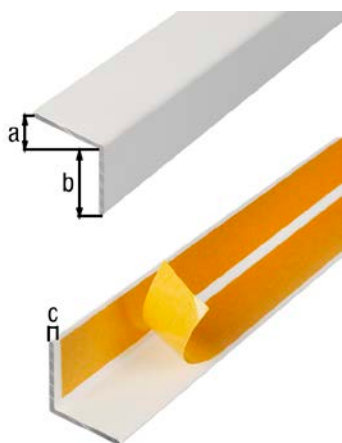

Angle profile, self-adhesive

Type: equal sided, self-adhesive

Length	Dimension a	Dimension b	Dimension c	UNIT	PU	Contents per PU	Deliv-ery time	Order no. 4004338...
Material: aluminium, Surface: white powder-coated RAL 9016								
1000 mm	20 mm	20 mm	1.5 mm	1	Piece	-	L	433512
1000 mm	30 mm	30 mm	2.0 mm	1	Piece	-	L	433550
2600 mm	20 mm	20 mm	1.5 mm	1	Piece	-	L	433529
2600 mm	30 mm	30 mm	2.0 mm	1	Piece	-	L	433567

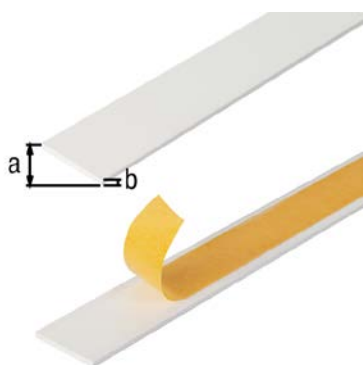

Flat bar, self-adhesive

Length	Dimension a	Dimension b	UNIT	PU	Contents per PU	Deliv-ery time	Order no. 4004338...
Material: PVC-U, colour: white							
2600 mm	20 mm	2 mm	1	Piece	-	L	431594
2600 mm	30 mm	3 mm	1	Piece	-	L	431617

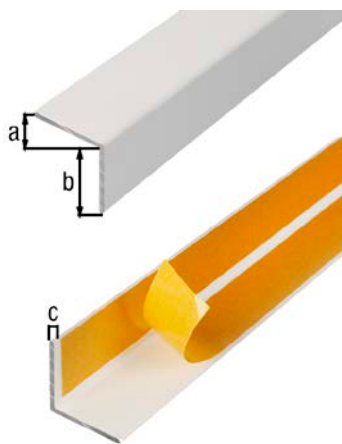

Angle profile, self-adhesive

Type: equal sided, self-adhesive

Length	Dimension a	Dimension b	Dimension c	UNIT	PU	Contents per PU	Deliv-ery time	Order no. 4004338...
Material: PVC-U, colour: white								
2600 mm	10 mm	10 mm	1.0 mm	1	Piece	-	L	431624
2600 mm	15 mm	15 mm	1.0 mm	1	Piece	-	L	433420
2600 mm	20 mm	20 mm	1.0 mm	1	Piece	-	L	433437
2600 mm	25 mm	25 mm	1.1 mm	1	Piece	-	L	433444
2600 mm	30 mm	30 mm	1.1 mm	1	Piece	-	L	431631
Material: PVC-U, colour: metallic grey								
1000 mm	20 mm	20 mm	1.5 mm	1	Piece	-	L	432928
2600 mm	20 mm	20 mm	1.5 mm	1	Piece	-	L	432935
Material: PVC-U, colour: stainless steel finish								
1000 mm	20 mm	20 mm	1.5 mm	1	Piece	-	L	432959
1000 mm	30 mm	30 mm	1.5 mm	1	Piece	-	L	433024
2600 mm	20 mm	20 mm	1.5 mm	1	Piece	-	L	432966
2600 mm	30 mm	30 mm	1.5 mm	1	Piece	-	L	433031
Material: PVC-U, colour: shiny white								
1000 mm	20 mm	20 mm	1.5 mm	1	Piece	-	L	432973
2600 mm	20 mm	20 mm	1.5 mm	1	Piece	-	L	432980
Material: PVC-U, colour: shiny black								
1000 mm	20 mm	20 mm	1.5 mm	1	Piece	-	L	433000
2600 mm	20 mm	20 mm	1.5 mm	1	Piece	-	L	433017

End profile, round, self-adhesive

Length	Dimension a	Dimension b	Dimension c	UNIT	PU	Contents per PU	Deliv-ery time	Order no. 4004338...
Material: plastic, colour: white								
1000 mm	19 mm	7 mm	1 mm	1	Piece	-	L	485245
2600 mm	19 mm	7 mm	1 mm	1	Piece	-	L	485252

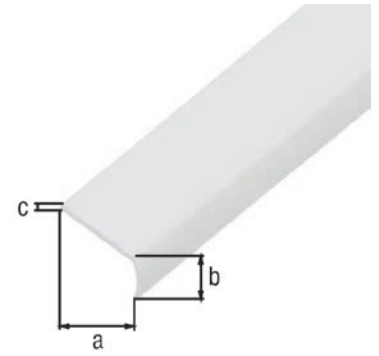

ASSEMBLY ACCESSORIES FOR PROFILES

Made to last.

Blind rivet with knuckle

for fast, secure assembly of several parts with total thickness from 5 - 6.5 mm

Assembly note: Pre-drill 4.1 mm holes. Assembly is carried out with standard commercial blind riveting tools.

Dimension a	Dimension b	UNIT	PU	Contents per PU	Deliv-ery time	Order no. 4004338...
Material: aluminium, steel pin: galvanised						
10 mm	4 mm	4	Blister	50 Piece	L	426606



Threaded plug for round tubes

Assembly note: Suitable for round tubes with a material thickness of 1.00 mm.

Dimension a-Ø	UNIT	PU	Contents per PU	Deliv-ery time	Order no. 4004338...
Material: plastic, colour: black					
15 mm	6	Blister	4 Piece	L	426668
20 mm	6	Blister	2 Piece	L	426675
25 mm	6	Blister	2 Piece	L	426682



Threaded plug for square tubes

Assembly note: Suitable for square tubes with dimensions of 15x15x1.0 mm, 20x20x1.5 mm and 25x25x1.5 mm.

Dimension a	UNIT	PU	Contents per PU	Deliv-ery time	Order no. 4004338...
Material: plastic, colour: black					
15 mm	6	Blister	4 Piece	L	426705
20 mm	4	Blister	4 Piece	L	426712
25 mm	4	Blister	4 Piece	L	426729

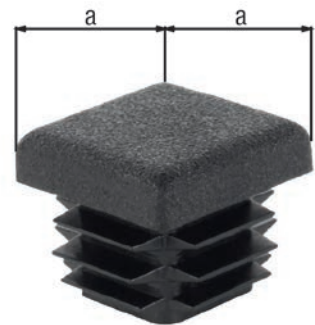

Threaded plug

for plugging square tubes
Thread: M8

• The formed thread can accommodate a set screw which can be used for height adjustment.

Assembly note: Suitable for square tubes with a material thickness of 1.5 mm.

Dimension a	UNIT	PU	Contents per PU	Deliv-ery time	Order no. 4004338...
Material: plastic, colour: black					
20 mm	4	Blister	4 Piece	L	426736
25 mm	4	Blister	4 Piece	L	426743

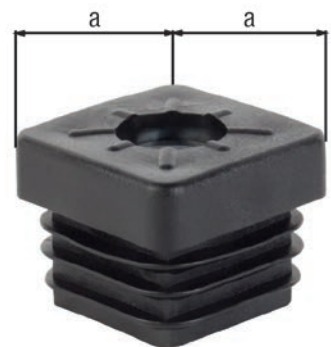



Threaded plug

for plugging round tubes
Thread: M8

- The formed thread can accommodate a set screw which can be used for height adjustment.

Assembly note: Suitable for round tubes with a material thickness of 1.00 mm.

Dimension a-Ø	UNIT	PU	Contents per PU	Deliv-ery time	Order no. 4004338...
Material: plastic, colour: black					
20 mm	4	Blister	4 Piece	L	426828
25 mm	4	Blister	4 Piece	L	426835

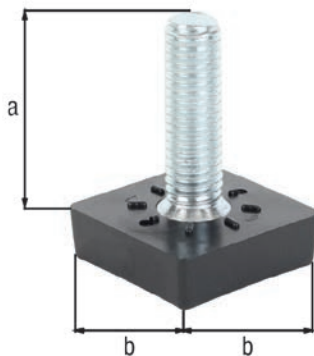

Adjusting screw for threaded plug

for height adjustment of square tubes in conjunction with threaded plug no. 426736 or 426743
Thread: M8

Dimension a	Dimension b	UNIT	PU	Contents per PU	Deliv-ery time	Order no. 4004338...
Material: plastic with steel thread						
15 mm	20 mm	4	Blister	4 Piece	L	426804
25 mm	25 mm	4	Blister	4 Piece	L	426811



Adjusting screw for threaded plug

for height adjustment of round tubes in conjunction with threaded plug no. 426828 or 426835
Thread: M8

Dimension a	Dimension b-Ø	UNIT	PU	Contents per PU	Deliv-ery time	Order no. 4004338...
Material: plastic with steel thread						
20 mm	20 mm	4	Blister	4 Piece	L	426873
30 mm	25 mm	4	Blister	4 Piece	L	426880



XD tube connector, straight

for connecting aluminium square tubes, e.g., when assembling shelves, tables, etc.
The maximum load/bearing capacity is calculated on the basis of the bending moment arising from the construction.

For tube	UNIT	PU	Contents per PU	Deliv-ery time	Order no. 4004338...
Material: polyamide, colour: black					
20 x 20 x 1.5 mm	10	Piece	-	L	426354
30 x 30 x 2.0 mm	10	Piece	-	L	426439

XD tube connector 90°

for connecting aluminium square tubes, e.g., when assembling shelves, tables, etc.
The maximum load/bearing capacity is calculated on the basis of the bending moment arising from the construction.

For tube	UNIT	PU	Contents per PU	Deliv-ery time	Order no. 4004338...
Material: polyamide, colour: black					
20 x 20 x 1.5 mm	10	Piece	-	L	426361
30 x 30 x 2.0 mm	10	Piece	-	L	426446



XD tube connector 90° with one additional right-angled outlet

for connecting aluminium square tubes, e.g., when assembling shelves, tables, etc.
The maximum load/bearing capacity is calculated on the basis of the bending moment arising from the construction.

For tube	UNIT	PU	Contents per PU	Deliv-ery time	Order no. 4004338...
Material: polyamide, colour: black					
20 x 20 x 1.5 mm	10	Piece	-	L	426347
30 x 30 x 2.0 mm	10	Piece	-	L	426422



XD tube connector T piece

for connecting aluminium square tubes, e.g., when assembling shelves, tables, etc.
The maximum load/bearing capacity is calculated on the basis of the bending moment arising from the construction.

For tube	UNIT	PU	Contents per PU	Deliv-ery time	Order no. 4004338...
Material: polyamide, colour: black					
20 x 20 x 1.5 mm	10	Piece	-	L	426378
30 x 30 x 2.0 mm	10	Piece	-	L	426453



XD tube connector T piece with one additional right-angled outlet

for connecting aluminium square tubes, e.g., when assembling shelves, tables, etc.
The maximum load/bearing capacity is calculated on the basis of the bending moment arising from the construction.

For tube	UNIT	PU	Contents per PU	Deliv-ery time	Order no. 4004338...
Material: polyamide, colour: black					
20 x 20 x 1.5 mm	10	Piece	-	L	426385
30 x 30 x 2.0 mm	10	Piece	-	L	426460





XD tube connector cross piece

for connecting aluminium square tubes, e.g., when assembling shelves, tables, etc.
The maximum load/bearing capacity is calculated on the basis of the bending moment arising from the construction.

For tube	UNIT	PU	Contents per PU	Deliv-ery time	Order no.
Material: polyamide, colour: black					
20 x 20 x 15 mm	10	Piece	-	L	426392



XD tube connector cross piece with one additional right-angled outlet

for connecting aluminium square tubes, e.g., when assembling shelves, tables, etc.
The maximum load/bearing capacity is calculated on the basis of the bending moment arising from the construction.

For tube	UNIT	PU	Contents per PU	Deliv-ery time	Order no.
Material: polyamide, colour: black					
20 x 20 x 15 mm	10	Piece	-	L	426408



XD tube connector cross piece with two additional right-angled outlet

for connecting aluminium square tubes, e.g., when assembling shelves, tables, etc.
The maximum load/bearing capacity is calculated on the basis of the bending moment arising from the construction.

For tube	UNIT	PU	Contents per PU	Deliv-ery time	Order no.
Material: polyamide, colour: black					
20 x 20 x 15 mm	10	Piece	-	L	426415

THREADED BARS

Made to last.



Threaded bar

Length: 1000 mm

Thread	UNIT	PU	Contents per PU	Deliv-ery time	Order no. 4004338...
Material: raw steel, Surface: blue galvanised					
M3	1	Piece	-	L	477707
M4	1	Piece	-	L	477714
M5	1	Piece	-	L	477721
M6	1	Piece	-	L	477738
M8	1	Piece	-	L	477745
M10	1	Piece	-	L	477752
M12	1	Piece	-	L	477769
M14	1	Piece	-	L	477776
M16	1	Piece	-	L	477783
M20	1	Piece	-	L	477790



Threaded bar

Length: 1000 mm

Thread	UNIT	PU	Contents per PU	Deliv-ery time	Order no. 4004338...
Material: stainless steel					
VA M6	1	Piece	-	L	484200
VA M8	1	Piece	-	L	484217
VA M10	1	Piece	-	L	484224

Nut and washer



Thread	UNIT	PU	Contents per PU	Deliv-ery time	Order no. 4004338...
Material: stainless steel					
VA M6	6	Blister	10 Piece	L	484248
VA M10	6	Blister	2 Piece	L	484262

CARPET AND LAMINATE PROFILES

Made to last.

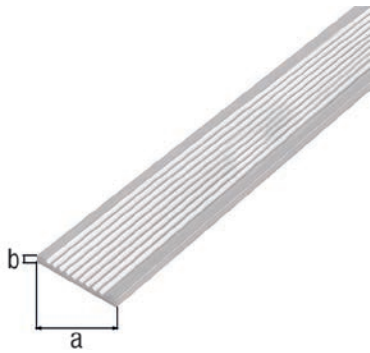

Flat profile, ruffled

Length	Dimension a	Dimension b	UNIT	PU	Contents per PU	Delivery time	Order no.
Material: aluminium, Surface: untreated							
1000 mm	30 mm	3 mm	1	Piece	-	L	465988
1000 mm	40 mm	3 mm	1	Piece	-	L	469863
2000 mm	30 mm	3 mm	1	Piece	-	L	470630

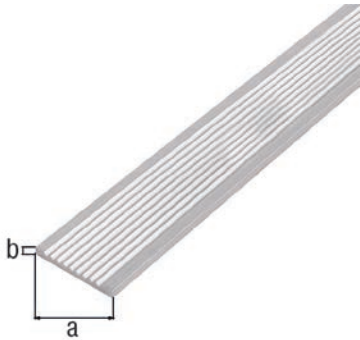

Flat profile, ruffled

Length: 1000 mm

Dimension a	Dimension b	UNIT	PU	Contents per PU	Delivery time	Order no.
Material: aluminium, Surface: silver anodised						
40 mm	3 mm	1	Piece	-	L	463144



Transition profile

Material thickness: 1.00 mm

Length	Dimension a	Height above ground	UNIT	PU	Contents per PU	Delivery time	Order no.
Material: steel, Surface: brass-plated, with countersunk screw holes							
900 mm	30 mm	5.3 mm	1	Piece	-	L	476007
900 mm	40 mm	5.5 mm	1	Piece	-	L	476014
2000 mm	30 mm	5.3 mm	1	Piece	-	L	479657
2000 mm	40 mm	5.5 mm	1	Piece	-	L	479664
Material: stainless steel, with countersunk screw holes							
VA 900 mm	30 mm	5.0 mm	1	Piece	-	L	476151
VA 2000 mm	30 mm	5.0 mm	1	Piece	-	L	479671
Material: hard PVC, Surface: grey, with countersunk screw holes							
900 mm	30 mm	5.3 mm	1	Piece	-	L	478650
Material: hard PVC, Surface: black, with countersunk screw holes							
900 mm	30 mm	5.3 mm	1	Piece	-	L	478667
Material: hard PVC, Surface: beige, with countersunk screw holes							
900 mm	30 mm	5.3 mm	1	Piece	-	L	478674
Material: hard PVC, Surface: brown, with countersunk screw holes							
900 mm	30 mm	5.3 mm	1	Piece	-	L	478681

Transition profile

with countersunk screw holes

Height above ground: 5.3 mm
Material thickness: 1.60 mm

Length	Dimension a	UNIT	PU	Contents per PU	Deliv-ery time	Order no. 4004338...
Material: aluminium, Surface: silver anodised						
900 mm	30 mm	1	Piece	-	L	479756
2000 mm	30 mm	1	Piece	-	L	479701
Material: aluminium, Surface: gold anodised						
900 mm	30 mm	1	Piece	-	L	479763
2000 mm	30 mm	1	Piece	-	L	479718
Material: aluminium, Surface: bronze colour anodised						
900 mm	30 mm	1	Piece	-	L	476205
2000 mm	30 mm	1	Piece	-	L	479725

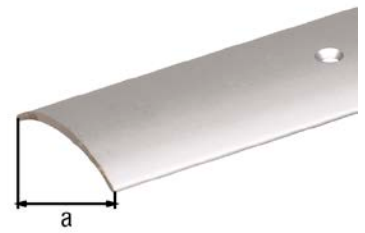

Transition profile

without screw holes
shrink-wrapped in film
Length: 900 mm
Material thickness: 1.60 mm

Dimension a	UNIT	PU	Contents per PU	Deliv-ery time	Order no. 4004338...
Material: aluminium, Surface: silver anodised					
30 mm	1	Piece	-	L	479602
Material: aluminium, Surface: gold anodised					
30 mm	1	Piece	-	L	479619
Material: aluminium, Surface: bronze colour anodised					
30 mm	1	Piece	-	L	479626

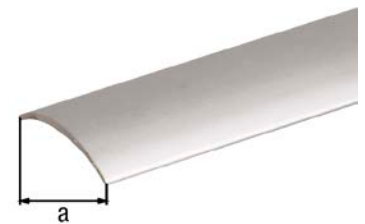

Transition profile

with countersunk screw holes

Height above ground: 5.0 mm
Material thickness: 1.00 mm

Length	Dimension a	UNIT	PU	Contents per PU	Deliv-ery time	Order no. 4004338...
Material: aluminium, Surface: silver anodised						
1000 mm	40 mm	1	Piece	-	L	475260
2000 mm	40 mm	1	Piece	-	L	475284
Material: aluminium, Surface: gold anodised						
1000 mm	40 mm	1	Piece	-	L	475277
2000 mm	40 mm	1	Piece	-	L	475291

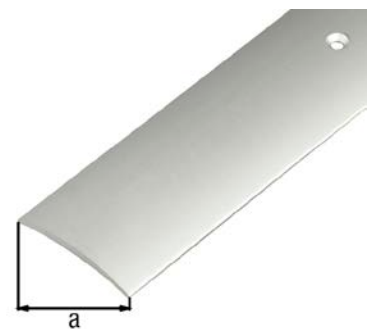

Transition profile

with two grooves
Material thickness: 1.80 mm



Length	Dimension a	UNIT	PU	Contents per PU	Deliv-ery time	Order no. 4004338...
Material: aluminium, Surface: silver anodised, with countersunk screw holes						
900 mm	25 mm	1	Piece	-	L	484132
2000 mm	25 mm	1	Piece	-	L	484163
Material: aluminium, Surface: gold anodised, with countersunk screw holes						
900 mm	25 mm	1	Piece	-	L	484149
2000 mm	25 mm	1	Piece	-	L	484170
Material: aluminium, Surface: bronze colour anodised, with countersunk screw holes						
900 mm	25 mm	1	Piece	-	L	484156
2000 mm	25 mm	1	Piece	-	L	484187

Transition profile

with two grooves
Material thickness: 1.60 mm



Length	Dimension a	UNIT	PU	Contents per PU	Deliv-ery time	Order no. 4004338...
Material: aluminium, Surface: silver anodised, with countersunk screw holes						
900 mm	38 mm	1	Piece	-	L	479558
2000 mm	38 mm	1	Piece	-	L	479503
Material: aluminium, Surface: gold anodised, with countersunk screw holes						
900 mm	38 mm	1	Piece	-	L	476304
2000 mm	38 mm	1	Piece	-	L	479510
Material: aluminium, Surface: bronze colour anodised, with countersunk screw holes						
900 mm	38 mm	1	Piece	-	L	476311
2000 mm	38 mm	1	Piece	-	L	479527
Material: aluminium, Surface: silver anodised, self-adhesive, without screw holes						
900 mm	38 mm	1	Piece	-	L	484491
Material: aluminium, Surface: gold anodised, self-adhesive, without screw holes						
900 mm	38 mm	1	Piece	-	L	484484

Levelling profile

with countersunk screw holes

Height above ground: 6.5 mm
Material thickness: 2.00 mm



Length	Dimension a	UNIT	PU	Contents per PU	Deliv-ery time	Order no. 4004338...
Material: aluminium, Surface: silver anodised						
1000 mm	30 mm	1	Piece	-	L	484071
2000 mm	30 mm	1	Piece	-	L	484101
Material: aluminium, Surface: gold anodised						
1000 mm	30 mm	1	Piece	-	L	484088
2000 mm	30 mm	1	Piece	-	L	484118
Material: aluminium, Surface: bronze colour anodised						
1000 mm	30 mm	1	Piece	-	L	484095
2000 mm	30 mm	1	Piece	-	L	484125

End profile

Length	Dimension a	Dimension b	Dimension c	UNIT	PU	Contents per PU	Deliv-ery time	Order no. 4004338...
Material: aluminium, Surface: silver anodised								
1000 mm	24.5 mm	13.5 mm	9 mm	1	Piece	-	L	476557
2000 mm	24.5 mm	13.5 mm	9 mm	1	Piece	-	L	477059
Material: aluminium, Surface: gold anodised								
1000 mm	24.5 mm	13.5 mm	9 mm	1	Piece	-	L	476564
2000 mm	24.5 mm	13.5 mm	9 mm	1	Piece	-	L	477066
Material: aluminium, Surface: bronze colour anodised								
1000 mm	24.5 mm	13.5 mm	9 mm	1	Piece	-	L	476571

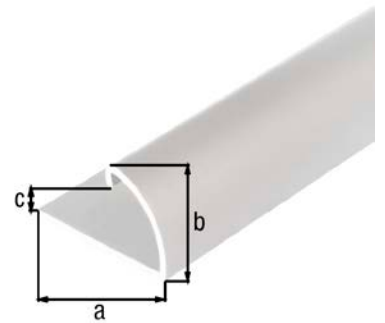

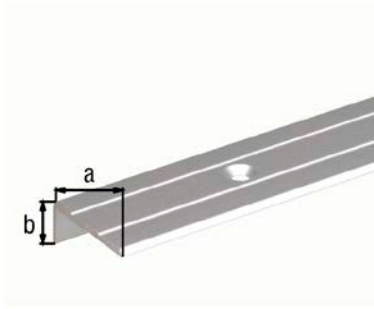

Stair nosing

with countersunk screw holes

Material thickness: 1.50 mm

Length	Dimension a	Dimension b	UNIT	PU	Contents per PU	Deliv-ery time	Order no. 4004338...
Material: aluminium, Surface: silver anodised							
1000 mm	25 mm	10 mm	1	Piece	-	L	476656
1000 mm	25 mm	20 mm	1	Piece	-	L	476755
2000 mm	25 mm	10 mm	1	Piece	-	L	477158
2000 mm	25 mm	20 mm	1	Piece	-	L	477257
Material: aluminium, Surface: gold anodised							
1000 mm	25 mm	10 mm	1	Piece	-	L	476663
1000 mm	25 mm	20 mm	1	Piece	-	L	476762
2000 mm	25 mm	10 mm	1	Piece	-	L	477165
2000 mm	25 mm	20 mm	1	Piece	-	L	477264
Material: aluminium, Surface: bronze colour anodised							
1000 mm	25 mm	10 mm	1	Piece	-	L	476670
1000 mm	25 mm	20 mm	1	Piece	-	L	476779
2000 mm	25 mm	10 mm	1	Piece	-	L	477172
2000 mm	25 mm	20 mm	1	Piece	-	L	477271

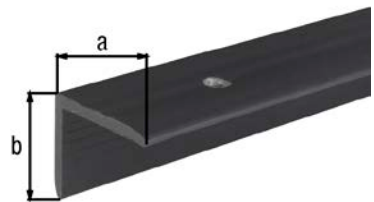

Stair nosing

with countersunk screw holes

Length: 1000 mm

Material thickness: 2.00 mm

Dimension a	Dimension b	UNIT	PU	Contents per PU	Deliv-ery time	Order no. 4004338...
Material: plastic, colour: black						
25 mm	20 mm	1	Piece	-	L	482886

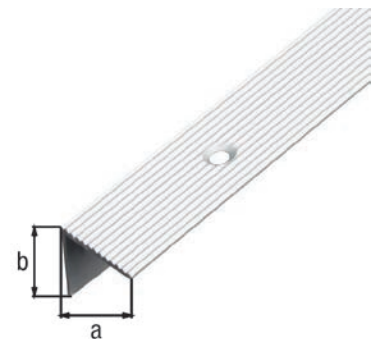

Stair nosing

with countersunk screw holes

Material thickness: 1.80 mm

Length	Dimension a	Dimension b	UNIT	PU	Contents per PU	Deliv-ery time	Order no. 4004338...
Material: aluminium, Surface: silver anodised							
1000 mm	21 mm	21 mm	1	Piece	-	L	476854
2000 mm	21 mm	21 mm	1	Piece	-	L	477356
Material: aluminium, Surface: gold anodised							
1000 mm	21 mm	21 mm	1	Piece	-	L	476861
2000 mm	21 mm	21 mm	1	Piece	-	L	477363
Material: aluminium, Surface: bronze colour anodised							
1000 mm	21 mm	21 mm	1	Piece	-	L	476878
2000 mm	21 mm	21 mm	1	Piece	-	L	477370

Stair nosing

with countersunk screw holes

Material thickness: 1.00 mm

Length	Dimension a	Dimension b	UNIT	PU	Contents per PU	Deliv-ery time	Order no. 4004338...
Material: aluminium, Surface: silver anodised							
2000 mm	20 mm	17.5 mm	1	Piece	-	L	471989

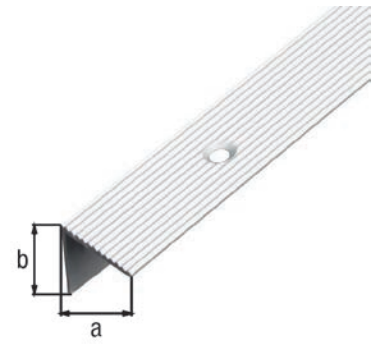

Stair nosing

with countersunk screw holes

Material thickness: 2.70 mm

Length	Dimension a	Dimension b	UNIT	PU	Contents per PU	Deliv-ery time	Order no. 4004338...
Material: aluminium, Surface: silver anodised							
1000 mm	45 mm	23 mm	1	Piece	-	L	484002
2000 mm	45 mm	23 mm	1	Piece	-	L	484040
Material: aluminium, Surface: gold anodised							
1000 mm	45 mm	23 mm	1	Piece	-	L	484019
2000 mm	45 mm	23 mm	1	Piece	-	L	484057
Material: aluminium, Surface: bronze colour anodised							
1000 mm	45 mm	23 mm	1	Piece	-	L	484026
2000 mm	45 mm	23 mm	1	Piece	-	L	484064



Stair nosing

Material thickness: 2.00 mm

Length	Dimension a	Dimension b	UNIT	PU	Contents per PU	Deliv-ery time	Order no. 4004338...
Material: aluminium, Surface: untreated							
1000 mm	25 mm	6 mm	1	Piece	-	L	470685
1000 mm	30 mm	6 mm	1	Piece	-	L	470722
1000 mm	40 mm	15 mm	1	Piece	-	L	470746
2000 mm	25 mm	6 mm	1	Piece	-	L	470692
2000 mm	30 mm	6 mm	1	Piece	-	L	470739
2000 mm	40 mm	15 mm	1	Piece	-	L	470784

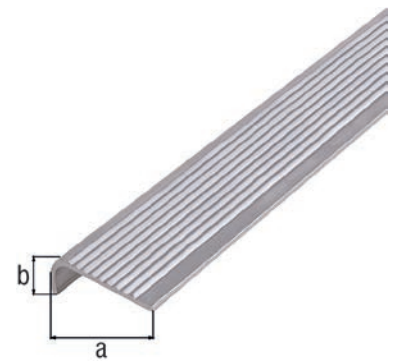

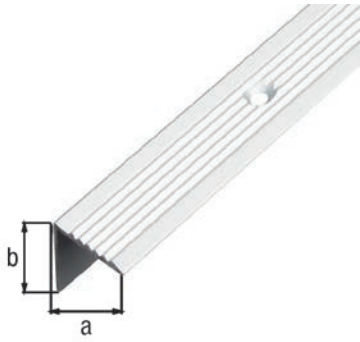

Stair nosing

with countersunk screw holes

Length: 1000 mm

Material thickness: 2.00 mm

Dimension a	Dimension b	UNIT	PU	Contents per PU	Deliv-ery time	Order no. 4004338...
Material: aluminium, Surface: silver anodised						
19 mm	19 mm	1	Piece	-	L	470791

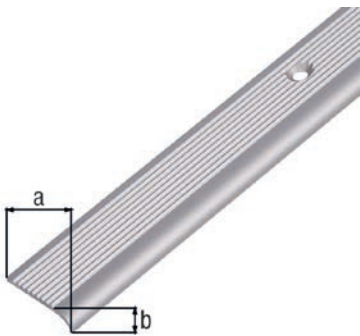

Stair nosing

with countersunk screw holes

Material thickness: 2.00 mm

Length	Dimension a	Dimension b	UNIT	PU	Contents per PU	Deliv-ery time	Order no. 4004338...
Material: aluminium, Surface: silver anodised							
1000 mm	23 mm	5 mm	1	Piece	-	L	476953
2000 mm	23 mm	5 mm	1	Piece	-	L	477455
Material: aluminium, Surface: gold anodised							
1000 mm	23 mm	5 mm	1	Piece	-	L	476960
2000 mm	23 mm	5 mm	1	Piece	-	L	477462
Material: aluminium, Surface: bronze colour anodised							
1000 mm	23 mm	5 mm	1	Piece	-	L	476977
2000 mm	23 mm	5 mm	1	Piece	-	L	477479

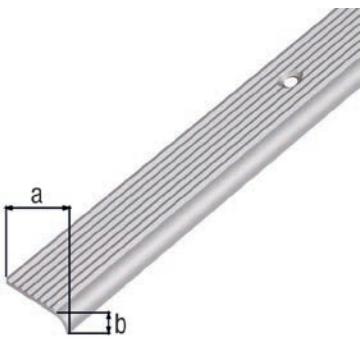

Stair nosing

with countersunk screw holes

Material thickness: 1.80 mm

Length	Dimension a	Dimension b	UNIT	PU	Contents per PU	Deliv-ery time	Order no. 4004338...
Material: aluminium, Surface: silver anodised							
2000 mm	23 mm	6 mm	1	Piece	-	L	471996

Screw and plug set

for the fixation of carpet profiles and stair nosings

countersunk head with Pozidriv (PZ) screw drive and wood thread with full thread

Set components: One set consists of 10 x countersunk head, crosshead wood screws and expansion plugs

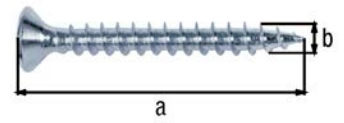

Dimension a	Dimension b	UNIT	PU	Contents per PU	Deliv-ery time	Order no. 4004338...
Material: raw steel, Surface: galvanised						
25 mm	3 mm	6	Blister	10 Piece	L	426200
Material: raw steel, Surface: brass-plated						
25 mm	3 mm	6	Blister	10 Piece	L	426217
Material: raw steel, Surface: browned						
25 mm	3 mm	6	Blister	10 Piece	L	426224

CARPET AND LAMINATE PROFILES, SHRINK-WRAPPED

Made to last.

Stair nosing, with drill holes

with countersunk screw holes

Material thickness: 1.50 mm

Accessory note: Fasteners included.

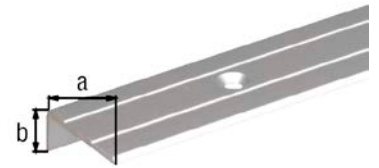

Length	Dimension a	Dimension b	UNIT	PU	Contents per PU	Deliv-ery time	Order no. 4004338...
Material: aluminium, Surface: silver anodised							
1000 mm	24.5 mm	10 mm	1	Piece	-	L	490133
1000 mm	24.5 mm	20 mm	1	Piece	-	L	490300
Material: aluminium, Surface: sand anodised							
1000 mm	24.5 mm	10 mm	1	Piece	-	L	490140
1000 mm	24.5 mm	20 mm	1	Piece	-	L	490317
Material: aluminium, Surface: stainless steel colour anodised							
1000 mm	24.5 mm	10 mm	1	Piece	-	L	490157
1000 mm	24.5 mm	20 mm	1	Piece	-	L	490324

Stair nosing, with drill holes

with countersunk screw holes

Material thickness: 1.80 mm

Accessory note: Fasteners included.

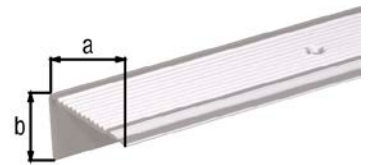

Length	Dimension a	Dimension b	UNIT	PU	Contents per PU	Deliv-ery time	Order no. 4004338...
Material: aluminium, Surface: silver anodised							
1000 mm	43 mm	23 mm	1	Piece	-	L	490447
Material: aluminium, Surface: sand anodised							
1000 mm	43 mm	23 mm	1	Piece	-	L	490454
Material: aluminium, Surface: stainless steel colour anodised							
1000 mm	43 mm	23 mm	1	Piece	-	L	490478

Transition profile, with drill holes

with countersunk screw holes

Height above ground: 4.7 mm
Material thickness: 1.00 mm

Accessory note: Fasteners included.



Length	Dimension a	UNIT	PU	Contents per PU	Deliv-ery time	Order no. 4004338...
Material: aluminium, Surface: silver anodised						
900 mm	30 mm	1	Piece	-	L	490010
Material: aluminium, Surface: sand anodised						
900 mm	30 mm	1	Piece	-	L	490027
Material: aluminium, Surface: stainless steel colour anodised						
900 mm	30 mm	1	Piece	-	L	490034

Transition profile, self-adhesive

Length: 900 mm



Dimension a	Material thickness	UNIT	PU	Contents per PU	Deliv-ery time	Order no. 4004338...
Material: aluminium, Surface: silver anodised						
30 mm	1.00 mm	1	Piece	-	L	490096
Material: aluminium, Surface: sand anodised						
30 mm	1.00 mm	1	Piece	-	L	490102
Material: aluminium, Surface: stainless steel colour anodised						
30 mm	1.00 mm	1	Piece	-	L	490119

Transition profile, with drill holes

with countersunk screw holes

Material thickness: 1.00 mm

Accessory note: Fasteners included.

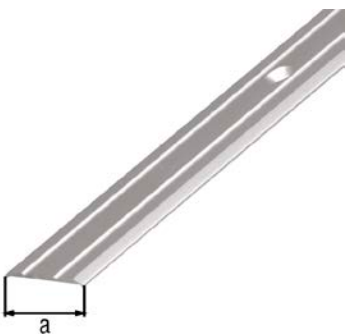

Length	Dimension a	UNIT	PU	Contents per PU	Deliv-ery time	Order no. 4004338...
Material: aluminium, Surface: silver anodised						
900 mm	38 mm	1	Piece	-	L	491376
Material: aluminium, Surface: stainless steel colour anodised						
900 mm	38 mm	1	Piece	-	L	491925
Material: aluminium, Surface: sand anodised						
900 mm	38 mm	1	Piece	-	L	491390
Material: aluminium, Surface: gold anodised						
900 mm	38 mm	1	Piece	-	L	491383

Transition profile, self-adhesive

Material thickness: 1.00 mm

Length	Dimension a	UNIT	PU	Contents per PU	Deliv-ery time	Order no. 4004338...
Material: aluminium, Surface: silver anodised						
900 mm	38 mm	1	Piece	-	L	491475
Material: aluminium, Surface: sand anodised						
900 mm	38 mm	1	Piece	-	L	491512
Material: aluminium, Surface: stainless steel colour anodised						
900 mm	38 mm	1	Piece	-	L	491482
Material: aluminium, Surface: gold anodised						
900 mm	38 mm	1	Piece	-	L	491499
Material: aluminium, Surface: bronze colour anodised						
900 mm	38 mm	1	Piece	-	L	491505



Levelling profile, with drill holes

with countersunk screw holes

Length: 900 mm

Material thickness: 2.00 mm

Accessory note: Fasteners included.

Dimension a	Dimension b	UNIT	PU	Contents per PU	Deliv-ery time	Order no. 4004338...
Material: aluminium, Surface: silver anodised						
30 mm	4 mm	1	Piece	-	L	490485
39 mm	8 mm	1	Piece	-	L	490560
Material: aluminium, Surface: sand anodised						
30 mm	4 mm	1	Piece	-	L	490492
39 mm	8 mm	1	Piece	-	L	490577
Material: aluminium, Surface: stainless steel colour anodised						
30 mm	4 mm	1	Piece	-	L	490508
39 mm	8 mm	1	Piece	-	L	490584

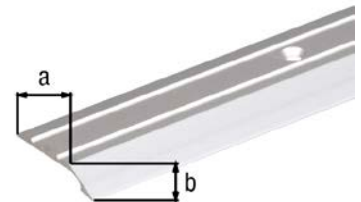

Levelling profile, self-adhesive

Material thickness: 2.00 mm

Length	Dimension a	Dimension b	UNIT	PU	Contents per PU	Deliv-ery time	Order no. 4004338...
Material: aluminium, Surface: silver anodised							
900 mm	30 mm	4 mm	1	Piece	-	L	490522
900 mm	39 mm	8 mm	1	Piece	-	L	490607
Material: aluminium, Surface: sand anodised							
900 mm	30 mm	4 mm	1	Piece	-	L	490539
900 mm	39 mm	8 mm	1	Piece	-	L	490621
Material: aluminium, Surface: stainless steel colour anodised							
900 mm	30 mm	4 mm	1	Piece	-	L	490546
900 mm	39 mm	8 mm	1	Piece	-	L	490638

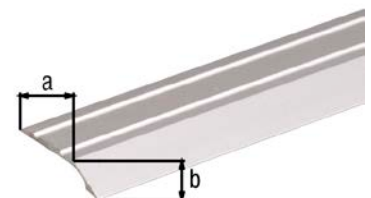

PROFILES FOR BLIND ASSEMBLY

Made to last.

Transition profile for blind assembly

with plastic plug
 Length: 900 mm
 For floor covering thicknesses: 0 - 20 mm
 Material thickness: 1.50 mm

Assembly note: The wall plug corrects differences in borehole positions of up to 2 mm.

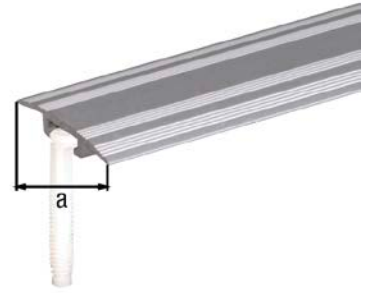

Dimension a	UNIT	PU	Contents per PU	Deliv-ery time	Order no. 4004338...
Material: aluminium, Surface: silver anodised					
32 mm	1	Piece	-	L	490799
Material: aluminium, Surface: sand anodised					
32 mm	1	Piece	-	L	490805
Material: aluminium, Surface: stainless steel colour anodised					
32 mm	1	Piece	-	L	490812

Levelling profile for blind assembly

with plastic plug
 Length: 900 mm
 For floor covering thicknesses: 0 - 20 mm
 Material thickness: 1.50 mm

Assembly note: The wall plug corrects differences in borehole positions of up to 2 mm.



Dimension a	UNIT	PU	Contents per PU	Deliv-ery time	Order no. 4004338...
Material: aluminium, Surface: silver anodised					
38 mm	1	Piece	-	L	490720
Material: aluminium, Surface: sand anodised					
38 mm	1	Piece	-	L	490737
Material: aluminium, Surface: stainless steel colour anodised					
38 mm	1	Piece	-	L	490744

FLOORING PROFILES

Made to last.

Transition profile Duo

For floor covering thicknesses: 6 - 13 mm
Material thickness: 1.80 mm

Accessory note: Fasteners included.

Set components: One set consists of one support profile and one cover profile

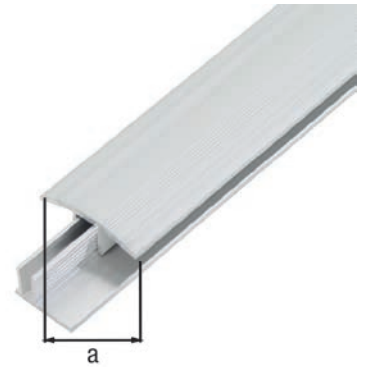

Length	Dimension a	UNIT	PU	Contents per PU	Deliv-ery time	Order no. 4004338...
Material: aluminium, Surface: support profile: raw, cover profile: silver anodised						
1000 mm	34 mm	1	Piece	-	L	492717
Material: aluminium, Surface: support profile: raw, cover profile: sand anodised						
1000 mm	34 mm	1	Piece	-	L	492731
Material: aluminium, Surface: support profile: raw, cover profile: stainless steel colour anodised						
1000 mm	34 mm	1	Piece	-	L	492700

Levelling profile Duo

For floor covering thicknesses: 6 - 13 mm
Material thickness: 1.80 mm

Accessory note: Fasteners included.

Set components: One set consists of one support profile and one cover profile



Length	Dimension a	UNIT	PU	Contents per PU	Deliv-ery time	Order no. 4004338...
Material: aluminium, Surface: support profile: raw, cover profile: silver anodised						
1000 mm	44 mm	1	Piece	-	L	492953
Material: aluminium, Surface: support profile: raw, cover profile: sand anodised						
1000 mm	44 mm	1	Piece	-	L	492977
Material: aluminium, Surface: support profile: raw, cover profile: stainless steel colour anodised						
1000 mm	44 mm	1	Piece	-	L	492946

End profile Duo

For floor covering thicknesses: 6 - 13 mm
Material thickness: 1.80 mm

Accessory note: Fasteners included.

Set components: One set consists of one support profile and one cover profile

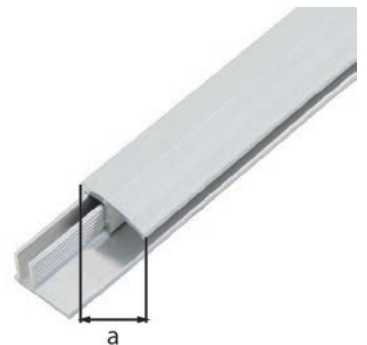

Length	Dimension a	UNIT	PU	Contents per PU	Deliv-ery time	Order no. 4004338...
Material: aluminium, Surface: support profile: raw, cover profile: silver anodised						
1000 mm	22 mm	1	Piece	-	L	492830
Material: aluminium, Surface: support profile: raw, cover profile: sand anodised						
1000 mm	22 mm	1	Piece	-	L	492854
Material: aluminium, Surface: support profile: raw, cover profile: stainless steel colour anodised						
1000 mm	22 mm	1	Piece	-	L	492823

Transition profile Pro

For floor covering thicknesses: 7 - 15 mm
Material thickness: 1.50 mm

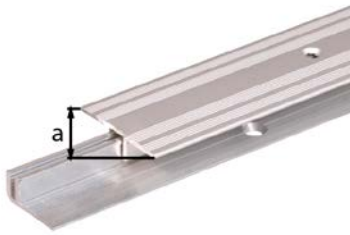

Accessory note: Fasteners included.

Set components: One set consists of one support profile and one cover profile

Length	Dimension a	UNIT	PU	Contents per PU	Deliv-ery time	Order no. 4004338...
Material: aluminium, Surface: support profile: raw, cover profile: silver anodised						
900 mm	34 mm	1	Piece	-	L	487065
2700 mm	34 mm	1	Piece	-	L	487072
Material: aluminium, Surface: support profile: raw, cover profile: stainless steel colour anodised						
900 mm	34 mm	1	Piece	-	L	487041
2700 mm	34 mm	1	Piece	-	L	487201

Levelling profile Pro

For floor covering thicknesses: 7 - 15 mm
Material thickness: 1.50 mm



Accessory note: Fasteners included.

Set components: One set consists of one support profile and one cover profile

Length	Dimension a	UNIT	PU	Contents per PU	Deliv-ery time	Order no. 4004338...
Material: aluminium, Surface: support profile: raw, cover profile: silver anodised						
900 mm	44 mm	1	Piece	-	L	487126
2700 mm	44 mm	1	Piece	-	L	487133
Material: aluminium, Surface: support profile: raw, cover profile: stainless steel colour anodised						
900 mm	44 mm	1	Piece	-	L	487102
2700 mm	44 mm	1	Piece	-	L	487225

End profile Pro

For floor covering thicknesses: 7 - 15 mm
Material thickness: 1.50 mm



Accessory note: Fasteners included.

Set components: One set consists of one support profile and one cover profile

Length	Dimension a	UNIT	PU	Contents per PU	Deliv-ery time	Order no. 4004338...
Material: aluminium, Surface: support profile: raw, cover profile: silver anodised						
900 mm	22 mm	1	Piece	-	L	487188
2700 mm	22 mm	1	Piece	-	L	487195
Material: aluminium, Surface: support profile: raw, cover profile: stainless steel colour anodised						
900 mm	22 mm	1	Piece	-	L	487164
2700 mm	22 mm	1	Piece	-	L	487249

TILE PROFILES

Made to last.

Tile end profile

Material thickness: 1.00 mm

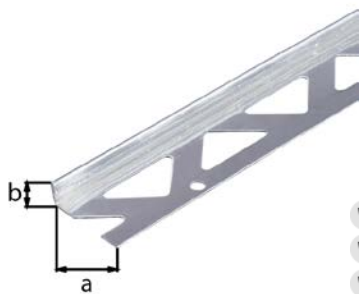

	Length	Dimension a	Dimension b	UNIT	PU	Contents per PU	Deliv-ery time	Order no. 4004338...
Material: stainless steel								
VA	1000 mm	23.5 mm	8.0 mm	1	Piece	-	L	476793
VA	1000 mm	23.5 mm	10.0 mm	1	Piece	-	L	476809
VA	1000 mm	23.5 mm	12.5 mm	1	Piece	-	L	476816
VA	2500 mm	23.5 mm	8.0 mm	1	Piece	-	L	482756
VA	2500 mm	23.5 mm	10.0 mm	1	Piece	-	L	482763
VA	2500 mm	23.5 mm	12.5 mm	1	Piece	-	L	482770

Tile end profile

Material thickness: 1.00 mm

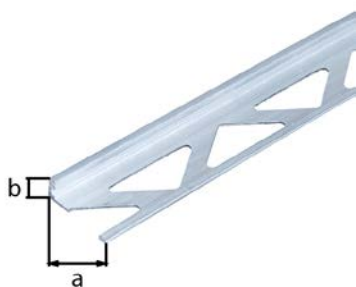

	Length	Dimension a	Dimension b	UNIT	PU	Contents per PU	Deliv-ery time	Order no. 4004338...
Material: aluminium, Surface: raw								
	1000 mm	23.5 mm	8.0 mm	1	Piece	-	L	475376
	1000 mm	23.5 mm	10.0 mm	1	Piece	-	L	475383
	1000 mm	23.5 mm	12.5 mm	1	Piece	-	L	475390
	2500 mm	23.5 mm	8.0 mm	1	Piece	-	L	475574
	2500 mm	23.5 mm	10.0 mm	1	Piece	-	L	475581
	2500 mm	23.5 mm	12.5 mm	1	Piece	-	L	475680
Material: aluminium, Surface: silver anodised								
	1000 mm	23.5 mm	8.0 mm	1	Piece	-	L	475895
	1000 mm	23.5 mm	10.0 mm	1	Piece	-	L	475956
	1000 mm	23.5 mm	12.5 mm	1	Piece	-	L	475963
	2500 mm	23.5 mm	8.0 mm	1	Piece	-	L	475987
	2500 mm	23.5 mm	10.0 mm	1	Piece	-	L	475994
	2500 mm	23.5 mm	12.5 mm	1	Piece	-	L	476021

Tile end profile

Length: 2500 mm
Material thickness: 1.00 mm

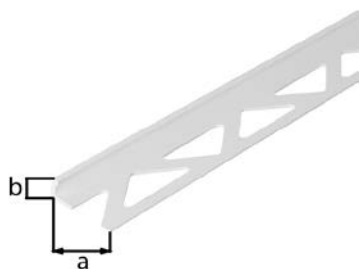

	Dimension a	Dimension b	UNIT	PU	Contents per PU	Deliv-ery time	Order no. 4004338...
Material: plastic, colour: white							
	23.5 mm	6 mm	1	Piece	-	L	476038
	23.5 mm	8 mm	1	Piece	-	L	476045
	23.5 mm	10 mm	1	Piece	-	L	476076

Tile quarter circle profile

Length: 2500 mm
Material thickness: 1.00 mm

Dimension a	Dimension b	UNIT	PU	Contents per PU	Deliv-ery time	Order no. 4004338...
Material: stainless steel						
29 mm	8.0 mm	1	Piece	-	L	476908 VA
29 mm	10.0 mm	1	Piece	-	L	476915 VA

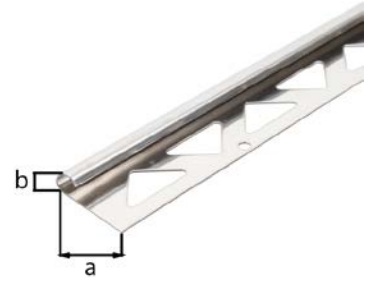

Tile quarter circle profile

Length: 2500 mm
Material thickness: 1.00 mm

Dimension a	Dimension b	UNIT	PU	Contents per PU	Deliv-ery time	Order no. 4004338...
Material: aluminium, Surface: silver anodised						
30.0 mm	8.0 mm	1	Piece	-	L	476236
32.0 mm	10.0 mm	1	Piece	-	L	476243

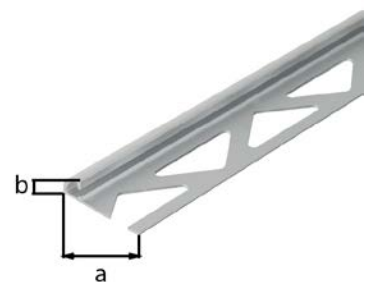

Tile quarter circle profile

Length: 2500 mm
Material thickness: 1.00 mm

Dimension a	Dimension b	UNIT	PU	Contents per PU	Deliv-ery time	Order no. 4004338...
Material: plastic, colour: white						
30 mm	6 mm	1	Piece	-	L	476489
30 mm	8 mm	1	Piece	-	L	476496
30 mm	10 mm	1	Piece	-	L	476526

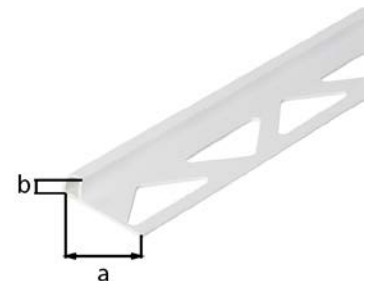

STORAGE SYSTEMS

Made to last.

Wall hook, double-angled

Max. load capacity: 40 kg
 Total width: 250 mm
 Tube Ø: 18 mm

Dimension a	Dimension b	Dimension c	Dimension d	UNIT	PU	Contents per PU	Deliv-ery time	Order no. 4004338...
Material: raw steel, Surface: blue galvanised								
125 mm	165 mm	250 mm	130 mm	4	Piece	-	L	802028

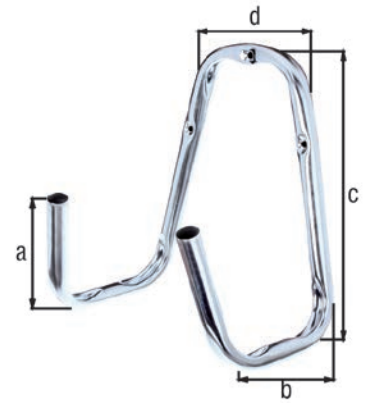

Wall hook, angled

Dimension a	Dimension b	Dimension c	Tube Ø	Max. load capacity	UNIT	PU	Contents per PU	Deliv-ery time	Order no. 4004338...
Material: raw steel, Surface: blue galvanised									
120 mm	80 mm	40 mm	12 mm	25 kg	5	Piece	-	L	802073
140 mm	115 mm	55 mm	12 mm	13 kg	5	Piece	-	L	802080
215 mm	150 mm	85 mm	18 mm	40 kg	5	Piece	-	L	802042
300 mm	250 mm	90 mm	18 mm	20 kg	5	Piece	-	L	802059

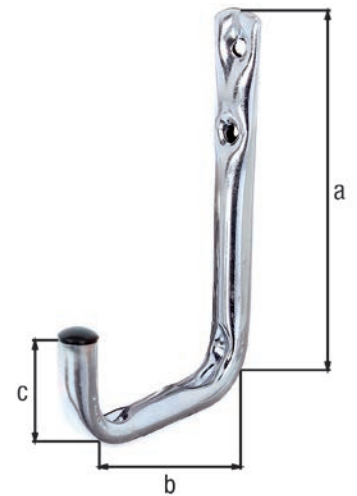

Wall hook, angled

with red rubber coating

Dimension a	Dimension b	Dimension c	Tube Ø	Max. load capacity	UNIT	PU	Contents per PU	Deliv-ery time	Order no. 4004338...
Material: raw steel, Surface: galvanised, grey, powder-coated									
120 mm	83 mm	48 mm	12 mm	25 kg	5	Piece	-	L	802158
145 mm	115 mm	52 mm	12 mm	13 kg	5	Piece	-	L	802165
215 mm	153 mm	85 mm	18 mm	40 kg	5	Piece	-	L	802189
300 mm	250 mm	90 mm	18 mm	20 kg	5	Piece	-	L	802196

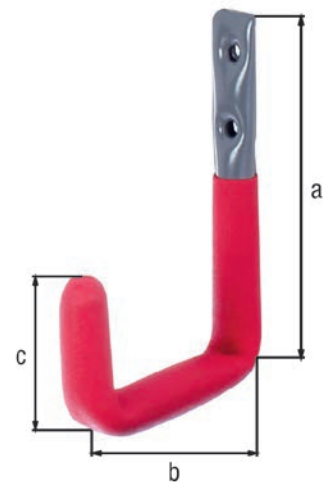

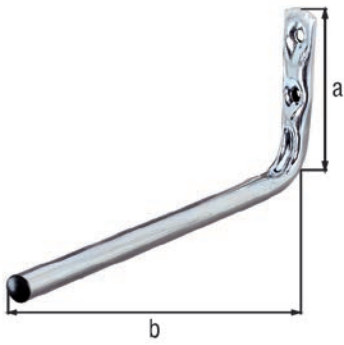

Wall hook, straight

Max. load capacity: 5 kg
Tube Ø: 12 mm

Dimension a	Dimension b	UNIT	PU	Contents per PU	Deliv-ery time	Order no. 4004338...
Material: raw steel, Surface: blue galvanised						
70 mm	175 mm	5	Piece	-	L	802097

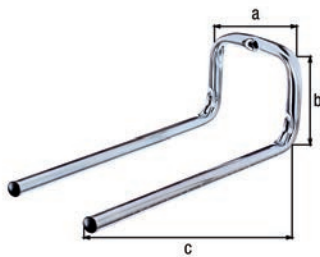

Wall hook, double-angled, straight

Max. load capacity: 10 kg
Tube Ø: 12 mm

Dimension a	Dimension b	Dimension c	UNIT	PU	Contents per PU	Deliv-ery time	Order no. 4004338...
Material: raw steel, Surface: blue galvanised							
90 mm	80 mm	200 mm	5	Piece	-	L	802103

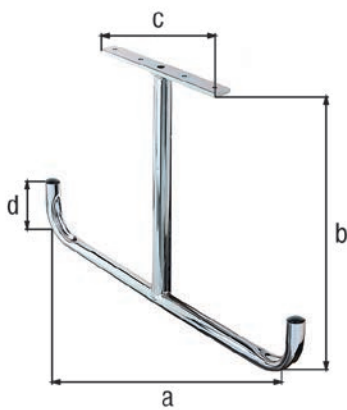

Ceiling hook, T shape, angled

Max. load capacity: 20 kg
Plate: 20 x 5 mm
Tube Ø: 18 mm

Dimension a	Dimension b	Dimension c	Dimension d	UNIT	PU	Contents per PU	Deliv-ery time	Order no. 4004338...
Material: raw steel, Surface: blue galvanised								
430 mm	295 mm	180 mm	95 mm	5	Piece	-	L	802066

Ceiling hook, curved

Tube Ø	Dimension a	Dimension b	Dimension c	Dimension d	Max. load capacity	UNIT	PU	Contents per PU	Deliv-ery time	Order no. 4004338...
Material: raw steel, Surface: blue galvanised										
12 mm	70 mm	160 mm	110 mm	50 mm	10 kg	5	Piece	-	L	802127
18 mm	155 mm	255 mm	150 mm	70 mm	20 kg	5	Piece	-	L	802134

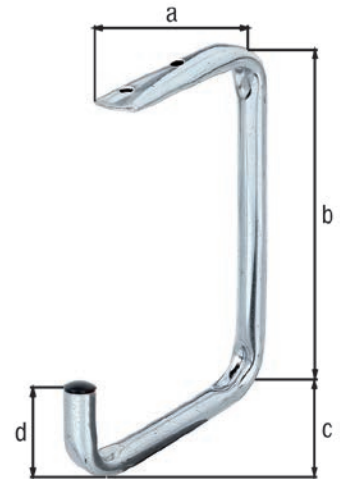

Surfboard holder, angled, for fixing to the wall

Max. load capacity: 15 kg
Tube Ø: 18 mm

- Foam underlay to protect surfboards

Dimension a	Dimension b	Dimension c	UNIT	PU	Contents per PU	Deliv-ery time	Order no. 4004338...
Material: raw steel, Surface: blue galvanised							
180 mm	200 mm	270 mm	5	Piece	-	L	802141

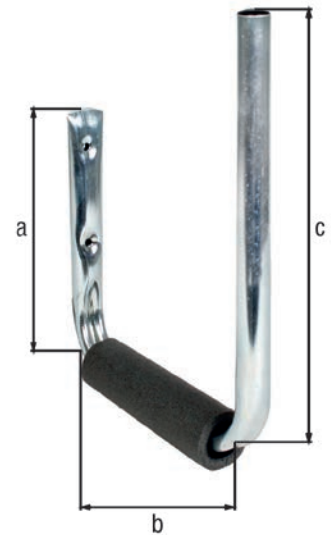

Boot holder, angled, for one pair of boots

Max. load capacity: 5 kg
Tube Ø: 12 mm

Dimension a	Dimension b	Dimension c	Dimension d	UNIT	PU	Contents per PU	Deliv-ery time	Order no. 4004338...
Material: raw steel, Surface: blue galvanised								
120 mm	60 mm	90 mm	200 mm	5	Piece	-	L	802226

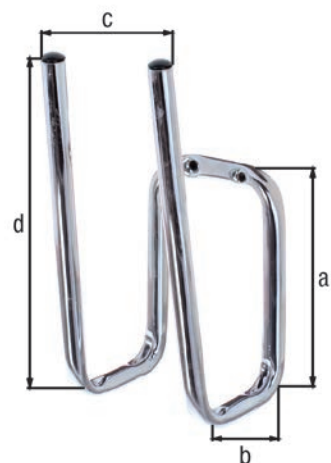



Wall hook, double-angled

Tube Ø: 12 mm

Dimension a	Dimension b	Dimension c	Max. load capacity	UNIT	PU	Contents per PU	Deliv-ery time	Order no. 4004338...
Material: raw steel, Surface: blue galvanised								
115 mm	80 mm	90 mm	20 kg	5	Piece	-	L	802240
120 mm	160 mm	90 mm	10 kg	5	Piece	-	L	802257
120 mm	245 mm	90 mm	8 kg	6	Piece	-	L	802264
120 mm	330 mm	90 mm	6 kg	6	Piece	-	L	802271

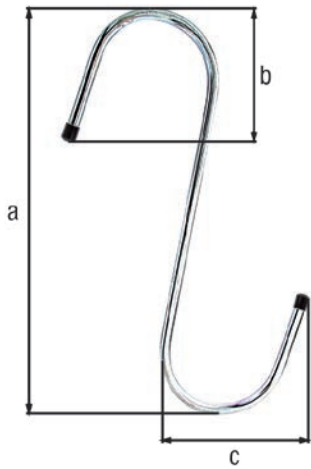

S-hook

Diameter: 6 mm

Dimension a	Dimension b	Dimension c	Max. load capacity	UNIT	PU	Contents per PU	Deliv-ery time	Order no. 4004338...
Material: raw steel, Surface: blue galvanised								
180 mm	70 mm	60 mm	15 kg	5	Piece	-	L	802288

Wall hook, curved

material: flat steel
e.g. for storing beverage crates

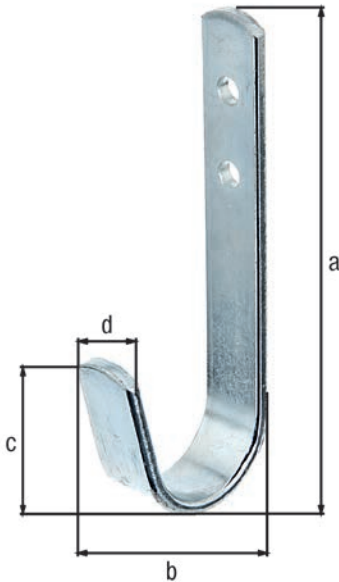

Dimension a	Dimension b	Dimension c	Dimension d	Max. load capacity	UNIT	PU	Contents per PU	Deliv-ery time	Order no. 4004338...
Material: raw steel, Surface: blue galvanised									
90 mm	30 mm	35 mm	14 mm	25 kg	20	Piece	-	L	802110
110 mm	60 mm	60 mm	20 mm	30 kg	10	Piece	-	L	802295
180 mm	100 mm	80 mm	25 mm	40 kg	10	Piece	-	L	802301

Ladder hook, angled, set of two pieces

material: flat steel
Max. load capacity: 50 kg

Dimension a	Dimension b	Dimension c	UNIT	PU	Contents per PU	Delivery time	Order no. 4004338...
Material: raw steel, Surface: hot-dip galvanised							
150 mm	210 mm	275 mm	1	Card	2 Piece	L	802202

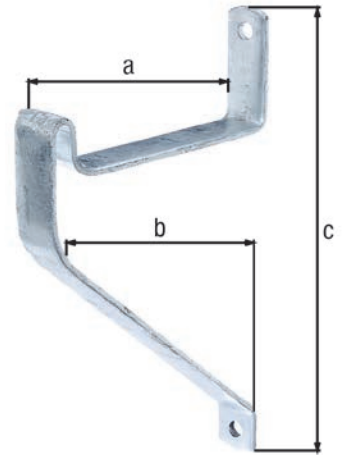

Ladder hook, set of two pieces

Type: lockable
Max. load capacity: 15 kg

Accessory note: Scope of supply includes two master keyed profile cylinders, each with three keys.

Dimension a	Dimension b	Dimension c	Dimension d	UNIT	PU	Contents per PU	Delivery time	Order no. 4004338...
Material: raw steel, Surface: blue galvanised								
216 mm	138 mm	16 mm	282 mm	1	Collar	2 Piece	L	802622

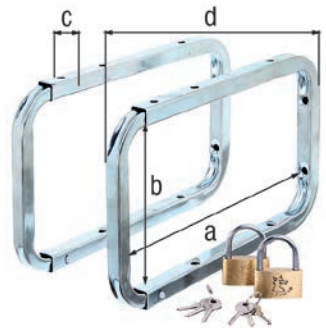

Bicycle hook, curved, for fixing to the ceiling

Max. load capacity: 40 kg
Tube Ø: 18 mm

Dimension a	Dimension b	Dimension c	UNIT	PU	Contents per PU	Delivery time	Order no. 4004338...
Material: raw steel, Surface: blue galvanised							
150 mm	150 mm	110 mm	6	Piece	-	L	802219

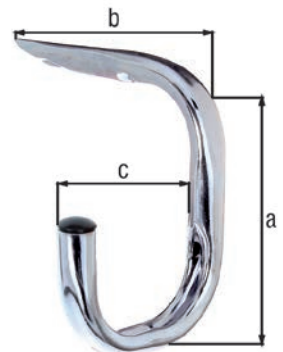

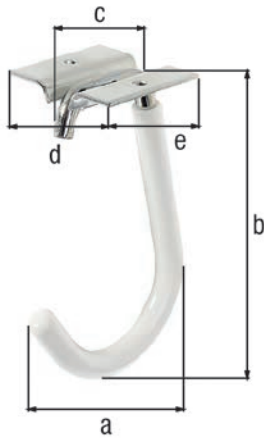

Bicycle hook, curved, for fixing to the ceiling

Max. load capacity: 20 kg
Diameter: 8 mm

- Underlay with plastic lining
- Individual parts attached with cable ties

Accessory note: Mounting plate included.
Fasteners are not included.

Dimension a	Dimension b	Dimension c	Dimension d	Dimension e	UNIT	PU	Contents per PU	Deliv-ery time	Order no.
Material: raw steel, Surface: blue galvanised									
90 mm	115 mm	50 mm	60 mm	50 mm	5	Piece	-	L	801991

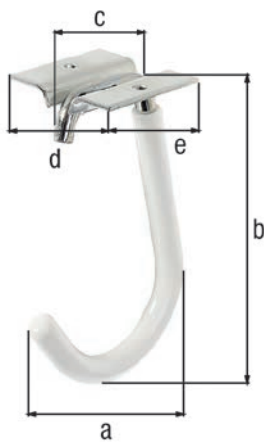

Bicycle hook, curved, for fixing to the ceiling

Max. load capacity: 20 kg
Diameter: 8 mm

- Underlay with plastic lining

Accessory note: Mounting plate included.
Fasteners included.

Dimension a	Dimension b	Dimension c	Dimension d	Dimension e	UNIT	PU	Contents per PU	Deliv-ery time	Order no.
Material: raw steel, Surface: blue galvanised									
90 mm	115 mm	50 mm	60 mm	50 mm	5	Card	1 Piece	L	802011

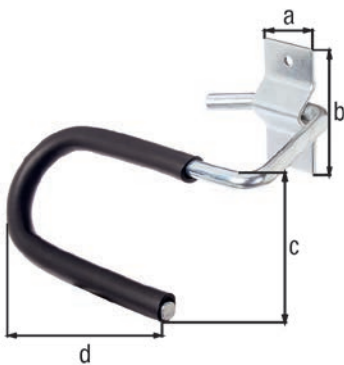

Ski holder, curved

Max. load capacity: 10 kg

- Safe holding device for a pair of skis with rubber cover sleeve
- Individual parts attached with cable ties

Dimension a	Dimension b	Dimension c	Dimension d	UNIT	PU	Contents per PU	Deliv-ery time	Order no.
Material: raw steel, Surface: blue galvanised								
40 mm	60 mm	70 mm	130 mm	5	Piece	-	L	801977

Rim holder, straight

with threaded rod, washer and wing nut
Max. load capacity: 25 kg

Dimension a	Dimension b	UNIT	PU	Contents per PU	Deliv-ery time	Order no. 4004338...
Material: raw steel, Surface: blue galvanised						
100 mm	200 mm	5	Piece	-	L	801984

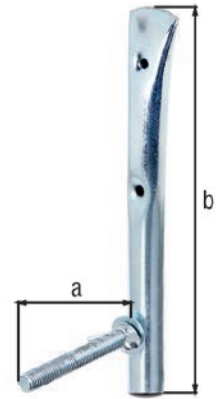

Rim holder set

includes fasteners
Max. load capacity: 40 kg
Plate thickness: 5 mm

Set components: One set consists of four rim holder, eight metal screws, eight metal dowels

Dimension a	Dimension b	Dimension c	UNIT	PU	Contents per PU	Deliv-ery time	Order no. 4004338...
Material: raw steel, Surface: galvanised, with PVC cover							
200 mm	120 mm	40 mm	5	Box	4 Set	L	801960

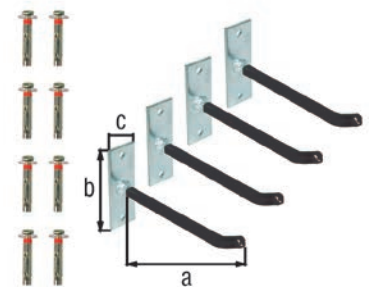

Pegboard hook, straight

Diameter: 4 mm

Dimension a	Max. load capacity	UNIT	PU	Contents per PU	Deliv-ery time	Order no. 4004338...
Material: raw steel, Surface: blue galvanised						
80 mm	7 kg	25	Piece	-	L	805623

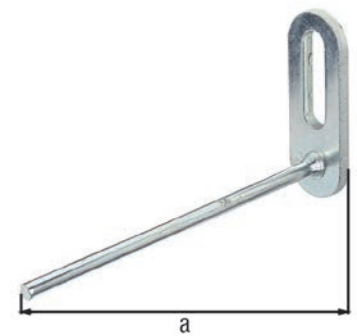

Pegboard hook, angled

Diameter: 7 mm

Dimension a	Max. load capacity	UNIT	PU	Contents per PU	Deliv-ery time	Order no. 4004338...
Material: raw steel, Surface: blue galvanised						
200 mm	16 kg	25	Piece	-	L	805647
300 mm	8 kg	25	Piece	-	L	805654

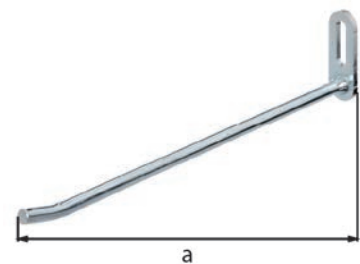

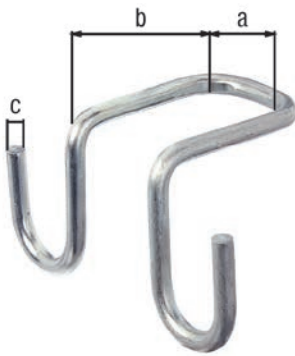

Ladder hook, in two sizes

Max. load capacity: 10 kg

- The hook makes it easy to hang various items on all ladders, so that the user can continue working on the ladder safely and comfortably.

Set components: One set consists of one hook with 60 mm depth and one hook with 82 mm depth

Dimension a	Dimension b	Dimension c-Ø	UNIT	PU	Contents per PU	Deliv-ery time	Order no. 4004338...
Material: raw steel, Surface: sendzimir galvanised							
30 mm	60 / 82 mm	6 mm	5	Card	2 Piece	L	802615

Storage support

designed for hanging on the wall or from the ceiling

Max. load capacity: 50 kg

Material thickness: 5.00 mm

- The storage support enables items to be stored on walls and ceilings to free up space. Also designed to store a beer table and two beer benches, it can be mounted horizontally or vertically.

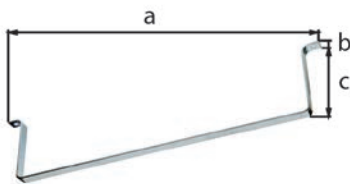

Dimension a	Dimension b	Dimension c	UNIT	PU	Contents per PU	Deliv-ery time	Order no. 4004338...
Material: raw steel, Surface: galvanised							
790 mm	25 mm	165 mm	1	Piece	-	L	802387

Screw hook

with black rubber covering

Max. load capacity: 30 kg

Wooden thread Ø: 7.5 mm

Material thickness: 5.00 mm



Dimension a	Dimension b	UNIT	PU	Contents per PU	Deliv-ery time	Order no. 4004338...
Material: raw steel, Surface: blue galvanised						
149 mm	67 mm	10	Piece	-	L	802707

Wall hook, straight

U profile width: 21.5 mm
U profile height: 9 mm

Dimension a	Dimension b	Max. load capacity	UNIT	PU	Contents per PU	Deliv-ery time	Order no. 4004338...
Material: aluminium							
160 mm	90 mm	15 kg	10	Piece	-	L	805500
230 mm	130 mm	10 kg	10	Piece	-	L	805517

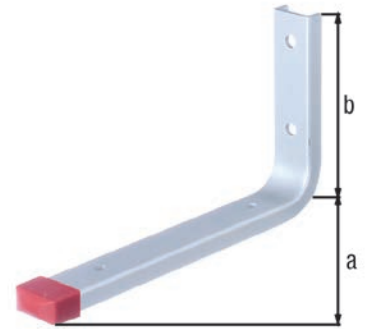

Wall hook, angled

U profile width: 21.5 mm
U profile height: 9 mm

Dimension a	Dimension b	Max. load capacity	UNIT	PU	Contents per PU	Deliv-ery time	Order no. 4004338...
Material: aluminium							
80 mm	120 mm	30 kg	10	Piece	-	L	805524
115 mm	140 mm	30 kg	10	Piece	-	L	805531
140 mm	155 mm	25 kg	10	Piece	-	L	805548
190 mm	200 mm	15 kg	10	Piece	-	L	805555

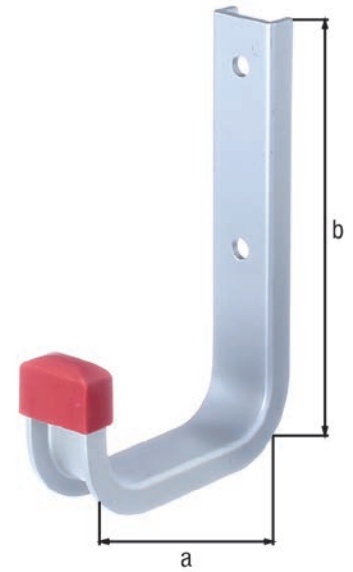

Ceiling hook, angled

Max. load capacity: 15 kg
U profile width: 21.5 mm
U profile height: 9 mm

Dimension a	Dimension b	Dimension c	UNIT	PU	Contents per PU	Deliv-ery time	Order no. 4004338...
Material: aluminium							
120 mm	160 mm	100 mm	10	Piece	-	L	805562
175 mm	220 mm	165 mm	10	Piece	-	L	805579

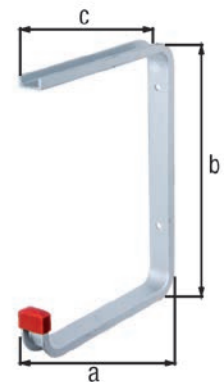

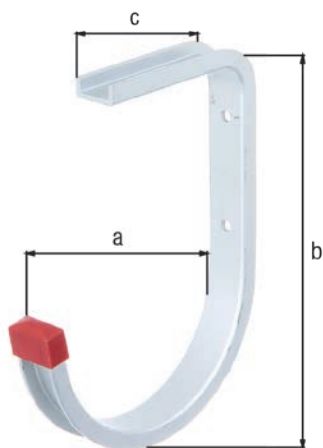

Ceiling hook, curved

Max. load capacity: 20 kg
 U profile width: 21.5 mm
 U profile height: 9 mm

Dimension a	Dimension b	Dimension c	UNIT	PU	Contents per PU	Deliv-ery time	Order no. 4004338...
Material: aluminium							
130 mm	170 mm	90 mm	10	Piece	-	L	805593

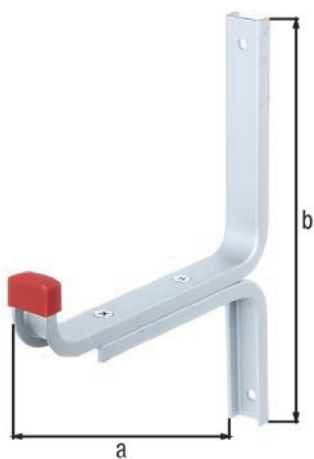

Wall hook, angled, reinforced

Max. load capacity: 50 kg
 U profile width: 21.5 mm
 U profile height: 9 mm

Dimension a	Dimension b	UNIT	PU	Contents per PU	Deliv-ery time	Order no. 4004338...
Material: aluminium						
170 mm	215 mm	10	Piece	-	L	805609

Shelf bracket, made of T profile

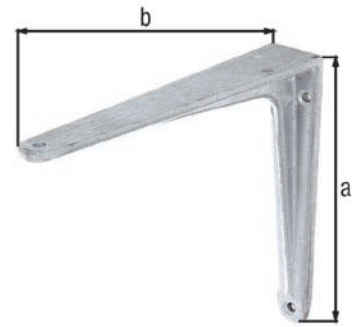

Dimension a	Dimension b	Max. load capacity	UNIT	PU	Contents per PU	Deliv-ery time	Order no. 4004338...
Material: cast aluminium							
150 mm	175 mm	70 kg	10	Piece	-	L	804022
175 mm	200 mm	75 kg	10	Piece	-	L	804039
200 mm	250 mm	80 kg	10	Piece	-	L	804046
250 mm	300 mm	90 kg	10	Piece	-	L	804053
300 mm	350 mm	100 kg	10	Piece	-	L	804060
350 mm	400 mm	130 kg	10	Piece	-	L	804077
450 mm	500 mm	160 kg	6	Piece	-	L	804091

Shelf bracket, made of T profile

for very heavy wear and load

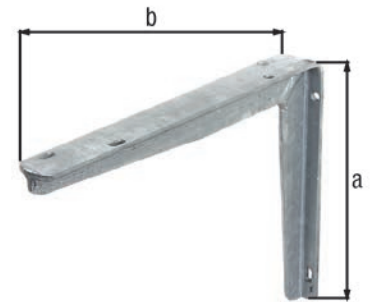

T iron	Dimension a	Dimension b	Max. load capacity	UNIT	PU	Contents per PU	Deliv-ery time	Order no. 4004338...
Material: raw steel, Surface: hot-dip galvanised								
30 x 30 x 4 mm	200 mm	250 mm	225 kg	1	Piece	-	L	800703
30 x 30 x 4 mm	250 mm	300 mm	250 kg	1	Piece	-	L	800710
40 x 40 x 5 mm	300 mm	400 mm	145 kg	1	Piece	-	L	800802
40 x 40 x 5 mm	300 mm	550 mm	110 kg	1	Piece	-	L	800819

Shelf bracket, made of U profile

with reinforcing brace
 U profile width: 30 mm
 U profile height: 15 mm
 U profile thickness: 1.75 mm

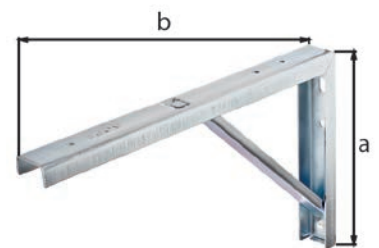

Dimension a	Dimension b	Max. load capacity	UNIT	PU	Contents per PU	Deliv-ery time	Order no. 4004338...
Material: raw steel, Surface: galvanised							
175 mm	300 mm	180 kg	10	Piece	-	L	803001
175 mm	400 mm	110 kg	10	Piece	-	L	803056
Material: raw steel, Surface: galvanised, white powder-coated							
175 mm	300 mm	180 kg	10	Piece	-	L	803025
175 mm	400 mm	110 kg	10	Piece	-	L	803070



Shelf bracket

Dimension a	Dimension b	Max. load capacity	UNIT	PU	Contents per PU	Deliv-ery time	Order no. 4004338...
Material: steel, Surface: brown painted							
125 mm	100 mm	39 kg	20	Piece	-	L	348786
150 mm	125 mm	48 kg	20	Piece	-	L	348793
200 mm	150 mm	62 kg	20	Piece	-	L	348809
175 mm	225 mm	55 kg	20	Piece	-	L	348540
250 mm	200 mm	114 kg	20	Piece	-	L	348816
300 mm	250 mm	166 kg	20	Piece	-	L	348823
300 mm	350 mm	200 kg	20	Piece	-	L	348830
350 mm	400 mm	234 kg	20	Piece	-	L	348557
Material: steel, Surface: grey painted							
75 mm	100 mm	30 kg	20	Piece	-	L	348847
125 mm	100 mm	39 kg	20	Piece	-	L	348885
150 mm	125 mm	48 kg	20	Piece	-	L	348892
200 mm	150 mm	55 kg	20	Piece	-	L	348922
250 mm	200 mm	114 kg	20	Piece	-	L	348939
300 mm	250 mm	166 kg	20	Piece	-	L	348946
Material: steel, Surface: white painted							
75 mm	100 mm	30 kg	20	Piece	-	L	348649
125 mm	100 mm	39 kg	20	Piece	-	L	348656
150 mm	125 mm	48 kg	20	Piece	-	L	348663
200 mm	150 mm	62 kg	20	Piece	-	L	348670
175 mm	225 mm	55 kg	20	Piece	-	L	348526
250 mm	200 mm	114 kg	20	Piece	-	L	348687
300 mm	250 mm	166 kg	20	Piece	-	L	348694
300 mm	350 mm	200 kg	20	Piece	-	L	348731

Bicycle hook, curved, for fixing to the ceiling

Max. load capacity: 40 kg
 Tube Ø: 18 mm

Dimension a	Dimension b	Dimension c	UNIT	PU	Contents per PU	Deliv-ery time	Order no. 4004338...
Material: raw steel, Surface: blue galvanised							
150 mm	150 mm	110 mm	6	Piece	-	L	802219

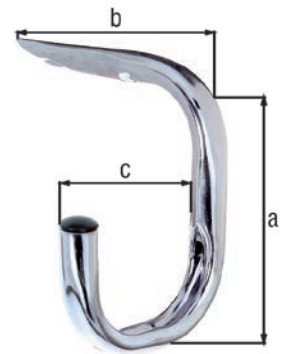

Bicycle hook, curved, for fixing to the ceiling

Max. load capacity: 20 kg
 Diameter: 8 mm

- Underlay with plastic lining
- Individual parts attached with cable ties

Accessory note: Mounting plate included.
 Fasteners are not included.

Dimension a	Dimension b	Dimension c	Dimension d	Dimension e	UNIT	PU	Contents per PU	Deliv-ery time	Order no. 4004338...
Material: raw steel, Surface: blue galvanised									
90 mm	115 mm	50 mm	60 mm	50 mm	5	Piece	-	L	801991

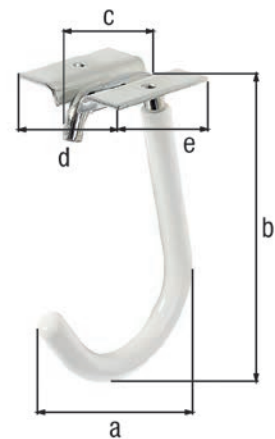

Bicycle hook, curved, for fixing to the ceiling

Max. load capacity: 20 kg
 Diameter: 8 mm

- Underlay with plastic lining

Accessory note: Mounting plate included.
 Fasteners included.

Dimension a	Dimension b	Dimension c	Dimension d	Dimension e	UNIT	PU	Contents per PU	Deliv-ery time	Order no. 4004338...
Material: raw steel, Surface: blue galvanised									
90 mm	115 mm	50 mm	60 mm	50 mm	5	Card	1 Piece	L	802011

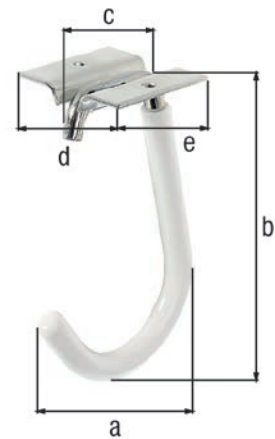



Bicycle holder

- With two wheel holding brackets and a pedal bracket, for mounting a bicycle on a wall.
- Enables you to store your bicycle in the smallest of spaces in the garage, laundry room, utility room, etc.
- You can also gain storage space on the floor by hanging your bicycle within easy reach.

Accessory note: Fasteners included.



UNIT	PU	Contents per PU	Delivery time	Order no. 4004338...
Material: raw steel, Surface: hot-dip galvanised				
5	Card	1 Piece	L	692391



Bicycle lift for fixing below the ceiling

with fall prevention mechanism
Max. load capacity: 20 kg

Accessory note: Supplied package includes fastening material, all included in one cardboard box.

Set components: One set consists of two holders with guide roller, two adjustable hooks with guide roller, one rope holder, 15 m rope



UNIT	PU	Contents per PU	Delivery time	Order no. 4004338...
Material: raw steel, Surface: galvanised				
1	Box	-	L	802318

Single bicycle holder

for fixing to the wall

Maximum clip distance: 20 - 42 mm
Clip Ø: 10 mm

Dimension a	Dimension b	Dimension c	Dimension d	Dimension e	Stand angle	UNIT	PU	Contents per PU	Deliv-ery time	Order no. 4004338...
Material: raw steel, Surface: hot-dip galvanised										
350 mm	140 mm	240 mm	45 mm	161 mm	90°	1	Piece	-	L	692216
350 mm	170 mm	240 mm	45 mm	161 mm	45°	1	Piece	-	L	692254

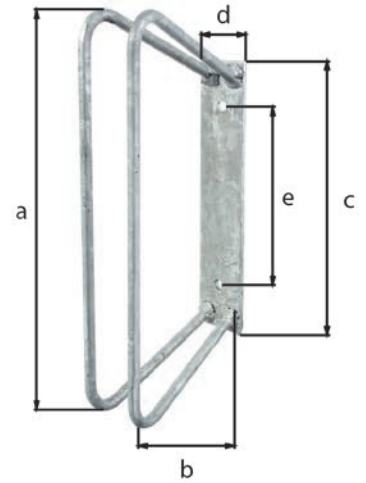

Single bicycle holder for mountain bikes

for fixing to the wall

Maximum clip distance: 25 - 65 mm
Clip Ø: 10 mm

Dimension a	Dimension b	Dimension c	Dimension d	Dimension e	Stand angle	UNIT	PU	Contents per PU	Deliv-ery time	Order no. 4004338...
Material: raw steel, Surface: hot-dip galvanised										
350 mm	140 mm	240 mm	60 mm	161 mm	90°	1	Piece	-	L	692483
350 mm	170 mm	240 mm	70 mm	161 mm	45°	1	Piece	-	L	692506

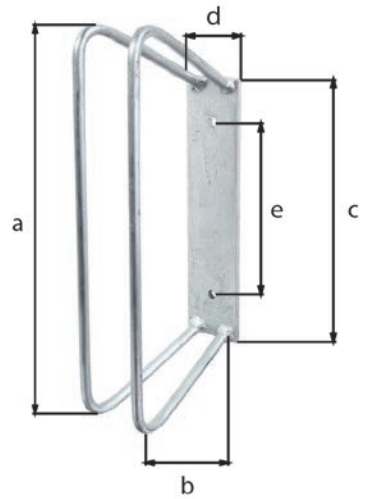

NUMERICAL INDEX

Order no.	Page	Order no.	Page	Order no.	Page	Order no.	Page	Order no.	Page	Order no.	Page	Order no.	Page
029993	278	113001	29	124359	34	137328	35	204600	145	209230	113	211745	161
030005	278	113018	29	124366	34	137335	35	204747	134	209377	22	211776	162
030104	279	113025	29	124618	28	137359	39	204808	125	209384	113	211806	162
030111	279	113100	29	124656	37	137366	39	204822	133	209391	141	211851	161
030128	279	113117	29	124663	37	137373	39	204853	143	209414	141	211868	161
030135	279	113124	29	126100	40	137380	39	204877	143	209551	118	212087	162&165
030142	280	113216	29	126148	40	137397	39	204907	142	209803	120	212209	133
030159	280	113261	29	126230	40	137403	39	204938	144	210120	118	212278	156
030166	279	113278	30	126247	40	137434	125	205003	150	210137	119	212391	158
030173	279	115364	30	126353	40	137458	124	205010	150	210144	20	212438	131
030180	279	115371	30	126360	40	137465	125	205638	168	210182	119	212681	156
030197	279	115388	30	127763	34	137472	128	205669	167	210205	119	212711	151
030203	280	115395	30	127961	34	137496	128	205676	167	210250	119	212766	154
030395	280	115401	30	128142	33	137502	129	205805	167	210328	118	212780	154
030401	278	115418	30	128159	34	137519	129	205829	168	210366	118	212797	154
030494	278	115425	30	128166	34	137533	124	205843	167	210397	118	212810	154
030500	279	116064	32	128500	36	137571	34	205867	168	210502	141	212827	154
030531	279	116071	32	128517	36	137588	34	205881	167	210557	177	212902	154
030548	279	116088	32	128869	29	137595	34	205928	167	210571	119	212919	154
030593	279	116712	20	128876	29	137601	34	205966	167	210601	35	213008	131
030609	280	116743	31	128890	29	202811	137	206505	121	210625	119	213053	117
030616	280	116750	31	128913	20	202828	137	206574	122	210656	121	213060	133
030623	279	116767	31	128944	29	202835	137	206581	122	210687	21	213091	21
030630	279	116774	31	128975	33	202859	138	207021	123	210694	130	213237	133
030647	279	116781	31	128982	33	202866	138	207069	123	210731	130	213244	131
030654	279	116798	31	128999	20	202873	136	207106	21	210779	130	213251	135
030661	280	116866	31	129026	35	202880	137	207502	142	210823	159	213275	133
030678	280	116873	31	129149	37	203917	149	207519	142	210854	124	213299	135
030685	278	116880	31	129156	37	203924	149	208028	159	210939	124	213312	132
030692	278	116910	31	132705	38	203931	149	208035	159	210953	124	213336	133
030708	279	116927	31	133566	39	203948	149	208103	163	211011	123	213374	132
030807	279	116934	31	134396	30	204143	113	208110	163	211028	123	213442	133
030814	279	117030	31	134402	30	204150	114	208127	163	211042	123	213459	133
030838	279	117047	31	136000	39&180	204167	114	208134	163	211066	123	213466	133
030845	280	117078	31	137007	33	204174	114	208172	163	211219	138	213473	134
030852	280	117160	32	137014	33	204181	114	208288	163	211233	164	213534	135
030869	278	117184	32	137021	33	204228	114	208370	164	211240	165	213565	117
030876	278	118563	32	137038	33	204242	114	208387	164	211271	163	213626	149
030883	279	118815	33	137045	33	204266	114	208394	165	211288	163	213718	150
030890	279	121501	40	137052	33	204273	114	208417	149	211295	163	213732	126
030906	280	122294	38	137076	35	204280	114	208424	149	211301	163	213800	149
030913	280	123055	32	137083	35	204297	114	208431	149	211318	163	213817	149
030920	279	123062	32	137090	35	204419	144	208448	150	211387	163	213824	149
030937	279	123079	32	137106	35	204426	144	208455	150	211394	163	213831	149
030944	280	123086	32	137113	38	204433	113	208509	151	211455	163	213848	149
030951	280	123154	36	137151	38	204440	113	208523	151	211462	163	213879	149
111618	28	123284	28	137168	38	204457	113	208707	160	211554	131	213886	149
111656	31	123352	28	137199	38	204464	113	208714	160	211561	131	213893	149
111663	28	123369	28	137229	38	204471	113	208721	160	211608	160	213916	149
111687	30	123376	28	137243	38	204488	113	208738	160	211615	160	213954	155
111700	36	124076	29	137250	38	204501	34	208790	136	211639	160	214005	156
111724	36	124083	29	137274	38	204518	144	208820	134	211653	162	214043	151
111748	36	124144	29	137281	33	204525	143	209193	114	211707	162	214067	151
111793	31	124151	38	137298	33	204532	143	209209	113	211714	161	214074	151
111809	31	124182	38	137304	35	204587	144	209216	113	211721	161	214098	151
112998	29	124212	35	137311	35	204594	144	209223	113	211738	161	214104	151

Order no.	Page	Order no.	Page	Order no.	Page	Order no.	Page	Order no.	Page	Order no.	Page	Order no.	Page
214203	152	217099	168	300289	13	301002	13	301835	11	306571	103	307394	101
214210	152	217228	168	300296	14	301118	15	301842	12	306588	103	307400	101
214234	150	217235	168	300302	17	301125	15	301859	12	306618	100	307417	101
214241	150	217242	168	300319	14	301132	15	301866	16	306625	100	307424	101
214258	150	217280	167	300326	14	301156	15	301873	16	306632	100	307431	179
214265	150	217297	167	300333	14	301163	15	301880	16	306656	99	307448	179
214289	150	217303	168	300340	13	301170	11	301897	17	306663	99	307455	128
214296	150	217310	168	300463	15	301187	12	301903	12	306670	98	307462	128
214302	150	217396	168	300470	15	301194	12	301910	14	306687	98	307479	128
214364	125	217402	168	300487	15	301200	16	301927	16	306694	98	307509	98
214401	151	217518	142	300494	15	301217	16	301934	16	306717	98	307516	83
214418	151	217532	158	300500	15	301224	16	301941	16	306724	98	307523	83
214432	155	217600	155	300517	11	301231	17	301958	16	306748	100	307530	93
214494	153	217617	155	300524	12	301248	12	301965	16	306755	100	307615	128
214500	152	217624	155	300531	12	301255	14	301972	16	306779	99	307622	128
214784	115	217631	155	300548	16	301262	16	302009	18	306786	99	307639	128
214791	115	217648	155	300555	16	301279	16	302016	18	306809	98	307646	127
214807	115	217679	160	300562	16	301286	16	302023	18	306816	98	307653	172
214814	115	218058	153	300579	17	301293	16	302047	18	306830	98	307684	83
214821	115	218102	158	300586	12	301309	16	302054	18	306847	98	307691	83
214838	115	218119	158	300593	14	301316	16	302061	18	306861	99	307707	176
214845	115	218232	136	300609	16	301323	8	302078	18	306922	83	307714	176
214890	153	219338	136	300616	16	301330	8	302085	18	306939	83	307745	176
215200	116	219611	126	300623	16	301361	8	302092	18	306946	83	307752	177
215224	116	219802	159	300630	16	301378	9	305994	100	306953	83	307769	177
215231	116	219819	159	300647	16	301385	9	306038	108	306960	93	307776	233
215361	116	219826	159	300654	16	301392	13	306045	108	307004	93	307783	233
215378	116	219901	154	300661	8	301408	13	306052	108	307011	93	307790	233
215446	157	219925	149	300678	8	301415	11	306069	108	307028	93	307806	233
215521	157	219949	149	300708	8	301422	11	306083	109	307035	172	307813	233
215538	157	220112	94	300715	9	301439	11	306090	109	307080	102	307820	233
215668	117	222277	122	300722	9	301446	11	306106	108	307097	174	307837	233
216245	160	223380	122	300739	13	301453	9	306113	108	307103	176	307851	103
216474	123	300005	8	300746	13	301460	9	306120	108	307127	176	308070	100
216511	121	300012	8	300753	11	301477	9	306137	108	307141	174	308124	175
216535	122	300043	8	300760	11	301484	10	306144	110	307158	174	308155	172
216559	132	300050	9	300777	11	301491	10	306151	110	307165	175	308162	172
216573	132	300067	9	300784	11	301507	10	306168	110	307189	179	308179	173
216610	132	300074	13	300791	9	301521	10	306175	110	307196	179	308186	173
216627	132	300081	13	300807	9	301538	10	306182	110	307202	175	308193	173
216634	132	300098	11	300814	9	301545	17	306199	110	307219	174	308209	173
216641	132	300104	11	300821	10	301583	17	306212	111	307226	174	308308	170
216658	132	300111	11	300838	10	301590	13	306229	110	307233	175	308438	179
216665	132	300128	11	300845	10	301606	13	306236	110	307257	177	308445	179
216672	132	300135	9	300852	10	301613	13	306243	110	307264	178	308452	177
216689	167	300142	9	300869	10	301620	14	306250	110	307271	178	308469	178
216740	152	300159	9	300876	17	301637	17	306342	170	307288	178	308483	170
216771	152	300166	10	300913	17	301644	14	306373	170	307295	179	308490	170
216795	152	300173	10	300920	13	301651	14	306403	170	307301	179	308506	108
216924	115	300180	10	300937	13	301668	14	306427	170	307318	178	308513	108
216931	115	300197	10	300944	13	301675	13	306458	170	307332	127	308544	108
216948	115	300203	10	300951	14	301781	15	306502	171	307349	127	308551	108
216979	115	300210	17	300968	17	301798	15	306519	171	307356	100	308568	108
216986	115	300258	17	300975	14	301804	15	306526	171	307363	100	308599	108
216993	115	300265	13	300982	14	301811	15	306557	171	307370	100	308704	111
217082	168	300272	13	300999	14	301828	15	306564	103	307387	100	308711	111

Order no.	Page	Order no.	Page	Order no.	Page	Order no.	Page	Order no.	Page	Order no.	Page	Order no.	Page
308728	111	311261	96	314002	104	316907	180	327057	37	330514	46	332037	56
308735	109	311308	96	314026	22	317508	177	327064	167	330521	46	332068	49
308742	109	311315	96	314033	22	318130	101	327071	167	330538	49	332075	57
308766	108	311353	96	314057	104	318178	105	327088	168	330545	49	332105	57
308780	110	311360	23	314095	105	318185	106	327095	168	330552	46	332150	57
308834	93	311377	23	314101	105	318192	104	327118	82	330576	46	332204	57
308841	93	311407	96	314149	105	318208	107	327125	92	330606	46	332259	68
308858	93	311438	96	314156	105	318215	96	327132	92	330644	48	332266	68
308865	93	311452	96	314194	105	318222	96	327149	49	330651	49	332280	52
308872	93	311469	96	314200	105	318239	101	327293	69	330705	49	332303	68
308940	178	311506	96	314248	105	318246	101	327309	48	330750	49	332334	48
308957	178	311513	96	314255	105	318253	108	329754	63	330774	49	332358	61
308988	205	312084	100	314293	105	318260	108	329808	62	330804	49	332396	61
308995	205	312138	100	314309	105	318277	108	329815	62	330835	48	332402	61
309220	173	312183	100	314330	172	318284	108	329822	62	330842	47	332457	61
309237	173	312237	100	314347	105	318321	108	329839	62	330859	49	332501	65
309282	174	312336	105	314354	105	318338	108	329846	62	330897	47	332525	48
309312	172	312343	105	314378	105	318406	107	329853	62	330903	49	332556	65
309336	180	312381	105	314446	172	318413	107	329860	62	330910	47	332594	61
309367	174	312398	105	314699	175	318758	101	329877	62	330927	47	332600	65
309411	233	312435	105	314743	176	318765	101	329884	62	330934	47	332624	65
309435	233	312442	105	314996	112	318772	97	329891	62	330941	53	332631	65
309442	233	312480	105	315009	112	318789	97	329907	62	330958	53	332648	52
309558	127	312497	105	315016	112	318796	97	329914	62	330996	47	332655	65
309770	96	312558	64	315023	112	318802	97	329952	71	331009	53	332679	65
309800	93	312565	64	315047	112	318994	99	329969	71	331054	53	332686	65
309817	93	312893	112	315085	94	320058	97	329976	71	331108	53	332693	48
309824	93	312909	112	315092	94	320102	98	330002	54	331153	53	332709	65
309831	93	312916	64	315146	94	320300	109	330026	54	331207	53	332723	65
309848	93	312947	112	315184	94	320355	109	330057	54	331252	50	332747	72
309855	93	312978	112	315191	94	320409	109	330071	54	331306	50	332754	66
309862	93	313043	64	315344	95	323011	120	330088	54	331351	50	332785	67
309879	93	313098	64	315382	95	323066	101	330101	54	331375	50	332808	66
309886	93	313104	111	315399	95	323509	109	330125	54	331382	50	332815	66
309893	93	313111	111	315443	95	323516	109	330149	48	331399	50	332839	68
310332	117	313128	111	315467	82	323523	110	330156	48	331405	50	332846	61
310387	117	313135	111	315474	82	323530	109	330187	48	331412	54	332853	63
310608	92	313166	111	315498	95	323547	102	330194	48	331429	54	332877	63
310615	92	313173	111	315504	82	323561	110	330200	48	331436	54	332907	63
310653	22	313319	170	315511	82	323608	97	330224	48	331450	50	332914	48
310660	92	313326	170	315528	82	323806	233	330255	48	331467	56	332938	48
310714	92	313531	23	315535	82	323813	233	330286	48	331474	56	332952	63
310813	92	313548	171	315542	82	326005	118	330309	48	331481	49	332976	48
310912	92	313630	104	315580	82	326012	120	330316	48	331498	49	333003	55&72
310950	22	313647	104	315627	82	326029	123	330323	48	331504	51	333034	62
310967	92	313692	104	315665	82	326128	100	330330	46	331559	51	333041	62
311018	92	313746	104	315702	82	326135	171	330354	46	331610	59	333058	69
311063	92	313791	104	315740	82	326142	92	330378	46	331634	59	333102	69
311117	96	313807	104	315788	82	326159	133	330408	48	331764	59	333126	69
311124	96	313838	104	315818	82	326197	119	330415	234	331788	59	333157	69
311131	102	313845	104	315900	82	326203	201	330422	234	331917	59	333171	69
311148	102	313869	104	315986	87	326210	201	330439	234	331955	56	333201	69
311155	96	313890	104	316020	87	327002	32	330446	234	331962	56	333225	69
311209	96	313913	104	316266	88	327019	35	330453	48	331993	56	333232	52
311230	96	313944	104	316389	88	327026	28	330477	234	332006	56	333256	69
311254	96	313968	104	316471	90	327040	33	330507	48	332020	56	333270	69

Order no.	Page	Order no.	Page	Order no.	Page	Order no.	Page	Order no.	Page	Order no.	Page	Order no.	Page
333287	61	334536	50	336615	47	338039	58	339425	57	340780	106	345990	77
333300	68	334642	54	336622	55	338046	68	339456	51	340797	106	346003	77
333355	68	334659	48	336639	233	338053	62	339463	61	340810	106	346010	77
333409	68	334666	46	336646	68	338077	53	339470	61	340834	106	346027	77
333508	69	334956	56	336660	61	338084	53	339500	63	340841	106	346096	77
333553	69	335007	50	336684	61	338091	53	339517	63	340865	106	346102	77
333607	69	335052	55&72	336691	68	338206	52	339524	63	340902	79	346188	77
333614	48	335069	67	336714	61	338220	182	339531	69	340919	79	346461	76
333621	67	335120	50	336738	61	338237	182	339548	62	341046	80	346478	76
333652	24	335144	50	336837	61	338251	183	339586	71	341053	80	346485	76
333669	24	335151	50	336851	63	338268	183	339593	77	341060	79	346492	76
333676	25	335168	50	336868	63	338275	182	339630	48	341244	79	346508	76
333751	79	335175	68	336899	61	338282	182	339739	64	341251	79	346515	76
333768	67	335182	50	336905	63	338299	182	339746	64	341268	79	346539	76
333775	67	335205	48	336912	63	338305	182	339753	54	341275	79	346553	76
333782	56	335212	46	336936	66	338312	183	339777	71	341282	79	346867	80
333799	56	335229	51	336950	63	338350	52	339784	71	341299	79	346874	80
333805	79	335243	50	336967	63	338381	182	339791	64	341305	79	346881	80
333829	25	335250	46	337001	63	338398	182	339807	47	341312	79	346898	80
333850	50	335267	46	337018	63	338480	54	339814	47	341329	79	346904	80
333867	25	335311	49	337025	63	338633	52	339821	50	341336	79	346911	80
333881	56	335335	50	337032	65	338657	183&224	339838	50	341343	67	346928	80
333898	56	335342	50	337049	65	338671	183&224	339845	64	341350	67	346935	80
333904	72	335359	51	337056	63	338695	183&224	339852	57	341367	67	347031	23
333942	25	335366	53	337063	65	338718	184&225	339876	26	341374	67	347062	75
333959	66	335373	53	337070	65	338725	184&225	339883	57	341381	67	347093	24
333966	25	335403	51	337087	69	338756	182	339890	57	341398	67	347109	83
334000	66	335410	50	337094	63	338763	182	339906	68	341404	67	347246	83
334055	68	335427	50	337117	70	338770	182	339913	68	341503	80	347284	83
334116	73	335458	51	337124	70	338787	182	339920	68	341534	204	347291	83
334123	73	335502	49	337131	70	338794	52	339937	68	341541	204	347314	83
334130	73	335557	49	337148	70	338886	65	339944	68	341572	204	347321	83
334147	73	335601	49	337155	70	338893	52	339951	68	345129	78	347338	83
334154	68	335632	51	337162	70	338909	52	339968	68	345136	78	347345	83
334161	73	335649	51	337179	70	338992	52	339982	54	345143	78	347482	84
334178	73	335656	67	337186	70	339012	52	340100	66	345150	78	347499	84
334208	73	335700	54	337193	70	339036	57	340131	66	345167	78	347505	84
334222	73	335717	46	337230	70	339043	57	340209	65	345174	78	347529	84
334239	73	335724	46	337247	70	339050	54	340230	65	345358	75	347536	84
334246	73	335755	49	337254	70	339067	49	340308	70	345365	75	347604	84
334253	73	335984	50	337261	70	339074	56	340339	70	345372	75	347611	84
334277	53	336011	61	337285	70	339135	69	340407	70	345389	75	347703	84
334284	53	336042	61	337292	70	339180	61	340438	70	345396	75	347710	84
334352	48	336066	61	337339	69	339197	61	340506	71	345402	75	347727	84
334369	48	336097	61	337346	69	339203	61	340513	55&72	345419	75	347772	85
334413	58	336134	61	337353	69	339210	61	340537	71	345426	75	347826	85
334420	58	336165	61	337360	69	339227	61	340544	171	345495	75	347826	85
334437	58	336189	61	337377	68	339234	61	340551	171	345877	76	347840	24
334444	58	336219	61	337384	68	339241	71	340667	106	345884	76	347857	85
334451	56	336264	61	337391	68	339258	71	340674	106	345891	76	347864	85
334468	54	336288	61	337421	69	339265	71	340681	106	345907	76	347871	85
334475	54	336417	71	337438	58	339289	71	340698	106	345914	76	347901	86
334499	54	336431	71	337445	69	339371	51	340704	106	345921	76	347918	86
334505	50	336486	71	337575	69	339388	61	340711	106	345969	77	347925	86
334512	50	336554	51	337582	49	339401	57	340766	102	345976	77	347956	85
334529	50	336561	55	337704	56	339418	57	340773	106	345983	77	347963	85

Order no.	Page	Order no.	Page	Order no.	Page	Order no.	Page	Order no.	Page	Order no.	Page	Order no.	Page
347970	83	351052	230	361419	87	412173	202	416119	187	422615	215	430481	284
347987	83	351069	230	361426	89	412180	202	416126	187	422646	214	430528	284
347994	83	351090	230	361433	90	412197	202	416447	190	422684	214	430566	284
348205	87	351458	230	361440	127	412302	191	416515	194	422882	215	430689	283
348212	87	351519	230	361471	101	412319	191	416805	196	422929	215	430726	283
348212	87	351540	230	361488	101	412326	191	416850	197	423001	216	430764	283
348229	87	351717	230	361495	121	412333	191	416867	197	423087	216	431280	284
348267	87	353162	50	361693	55	412401	192	417031	188	423322	214	431327	284
348304	88	353179	231	410216	195	412647	193	417055	188	423681	216	431365	284
348328	23	353186	231	410308	204	412661	193	417093	188	424282	210	431402	284
348359	89	353216	48	410322	204	412814	195	417116	188	424367	210	431440	284
348366	89	353322	55&72	410445	196	412821	195	417130	203	424442	210	431488	284
348373	89	353773	50	410476	196	412838	194	417147	203	424664	216	431501	282
348397	90	353780	50	410568	196	413057	189	417260	202	426200	323	431525	285
348403	89	353797	50	410643	198	413125	192	417284	202	426217	323	431532	257
348410	89	353803	50	410650	198	413132	190	417383	192	426224	323	431549	257
348458	89	353827	50	410674	198	413354	186	417628	140	426347	311	431556	257
348472	89	353902	51	410803	198	413378	186	417642	139	426354	310	431563	285
348496	90	353926	51	411008	198	413408	187	417666	139	426361	311	431570	256
348502	90	354725	50	411015	198	413415	187	417673	139	426378	311	431587	255
348519	90	354770	50	411022	198	413422	187	417758	126	426385	311	431594	306
348526	348	354947	50	411053	201	413453	188	417802	201	426392	312	431600	285
348540	348	354954	51	411060	201	413460	188	417819	201	426408	312	431617	306
348557	348	361006	54	411077	201	413668	192	417826	201	426415	312	431624	306
348649	348	361013	54	411084	201	413750	190	417833	201	426422	311	431631	306
348656	348	361020	48	411121	201	414306	199	417901	127	426439	310	431648	285
348663	348	361037	49	411138	201	414313	199	417918	127	426446	311	431662	263
348670	348	361044	49	411145	201	414320	199	417932	127	426453	311	431686	285
348687	348	361068	66	411152	201	414337	199	418021	204	426460	311	431723	285
348694	348	361075	65	411213	202	414344	199	418038	204	426606	309	431761	285
348731	348	361082	65	411220	202	414351	203	418045	204	426668	309	431815	283
348786	348	361099	61	411343	200	414375	203	418052	204	426675	309	431884	285
348793	348	361105	63	411350	200	414382	203	418304	199	426682	309	431921	285
348809	348	361112	61	411367	198	414399	203	418311	199	426705	309	431952	287
348816	348	361129	61	411374	198	414405	199	418328	199	426712	309	431976	287
348823	348	361136	61	411381	198	414412	199	418366	200	426729	309	431983	287
348830	348	361143	73	411398	198	414429	199	418373	200	426736	309	431990	287
348847	348	361150	71	411404	198	414436	199	418397	200	426743	309	432003	286
348885	348	361181	75	411558	198	414443	199	418403	200	426804	310	432010	287
348892	348	361198	75	411565	198	414450	199	418649	201	426811	310	432027	287
348922	348	361211	77	411572	198	414467	199	418656	201	426828	310	432041	282
348939	348	361235	76	411664	140	414474	199	418700	186	426835	310	432058	299
348946	348	361242	76	411671	140	414481	199	419035	193	426859	249	432065	299
348984	77	361259	77	411695	141	414498	199	419103	127	426873	310	432072	299
348991	76	361266	77	411725	197	414610	203	419462	202	426880	310	432089	299
349028	77	361273	77	411732	141	414627	203	420604	211	430085	282	432096	299
349035	77	361280	76	411756	128&195	414634	203	420680	212	430122	282	432102	286
349042	77	361297	76	411763	128&195	414641	203	420727	211	430160	282	432126	285
349073	75	361303	80	411794	141	414856	203	420765	211	430306	283	432133	287
349189	77	361310	80	412036	189	414863	203	421489	214	430313	288	432140	287
350161	57	361327	80	412043	189	414870	203	421885	213	430320	283	432157	287
350178	57	361334	80	412050	189	414887	203	421960	213	430337	288	432164	285
350208	51	361358	84	412067	189	414894	203	422042	213	430344	283	432171	287
350215	53	361372	85	412074	202	414900	203	422202	213	430368	282	432188	287
350222	51	361396	84	412081	191	414917	203	422240	213	430405	282	432195	287
351045	230	361402	84	412104	191	416102	187	422578	215	430443	284	432379	286

Order no.	Page	Order no.	Page	Order no.	Page	Order no.	Page	Order no.	Page	Order no.	Page	Order no.	Page
432409	284	433383	285	434816	278	465858	245	467197	241	469887	251	470692	321
432423	284	433406	284	434823	278	465872	298	467227	244	469894	251	470722	321
432430	284	433420	306	434830	278	465889	298	467241	244	469900	253	470739	321
432461	284	433437	306	434847	278	465896	243	467272	244	469917	251	470746	321
432485	284	433444	306	440022	217	465919	243	467289	244	469931	254	470777	241
432492	284	433451	297	440039	217	465957	239	467296	244	469955	258	470784	321
432515	285	433468	297	440060	217	465964	239	467326	246	469962	251	470791	322
432522	285	433475	297	441166	215	465971	239	467333	246	469979	251	470937	293
432539	285	433482	297	462802	247	465988	316	467340	246	469986	258	470944	294
432546	285	433499	298	462819	247	465995	256	467357	246	469993	258	470968	294
432553	285	433505	251	462826	247	466039	239	467371	246	470005	255	470999	294
432560	282	433512	306	462833	247	466046	239	467395	246	470012	245	471002	294
432577	282	433529	306	462840	247	466053	239	467401	246	470029	258	471019	293
432584	282	433536	305	462857	247	466060	239	467449	246	470043	297	471118	293
432591	282	433543	305	462864	248	466077	239	467456	244	470067	258	471125	293
432607	282	433550	306	462871	248	466084	239	467463	244	470081	256	471132	293
432614	282	433567	306	462888	248	466091	239	467654	249	470098	253	471149	293
432669	283	433574	305	462895	245	466107	239	467661	249	470104	257	471217	293
432676	283	433581	305	462901	247	466206	245	467678	249	470128	254	471224	293
432683	283	433598	305	462918	247	466213	245	467692	256	470142	257	471231	293
432690	283	433604	305	462925	247	466220	245	467708	256	470166	254	471248	293
432706	283	433611	305	462932	247	466237	245	467715	256	470180	253	471255	293
432713	284	433628	305	462949	247	466268	245	467722	256	470197	251	471316	293
432720	284	433635	305	462956	247	466275	245	467739	258	470203	300	471323	293
432737	284	433642	305	462963	248	466374	239	467746	258	470210	244	471330	293
432768	285	433659	305	462970	248	466459	241	467821	239	470227	255	471446	294
432775	285	433666	305	462987	248	466473	241	468002	239	470241	256	471453	294
432782	285	433727	303	462994	246	466480	241	468163	241	470265	298	471538	294
432799	285	433734	303	463106	245	466497	241	468187	241	470289	258	471545	294
432805	285	433741	303	463144	316	466534	241	468200	242	470296	253	471613	294
432812	285	433765	287	463267	251	466596	240	468354	240	470302	256	471644	262
432829	285	433772	287	463274	296	466619	240	468385	240	470326	258	471651	262
432836	282	433789	287	463281	253	466633	240	468576	245	470340	254	471668	262
432843	286	433796	287	463472	253	466695	240	468842	256	470357	257	471675	262
432928	306	433802	287	463489	252	466718	240	468859	256	470364	252	471682	262
432935	306	433819	287	463496	257	466725	240	468866	256	470371	252	471699	262
432942	286	433840	287	464233	242	466732	240	468873	256	470388	257	471705	262
432959	306	433857	287	464240	242	466756	240	468880	258	470395	296	471712	262
432966	306	433864	287	464257	242	466763	240	468897	258	470401	300	471729	260
432973	306	433871	287	464264	242	466770	240	468903	257	470425	252	471736	260
432980	306	433888	287	464721	240	466794	240	468910	257	470449	257	471743	260
432997	286	433895	287	464868	257	466817	242	468927	257	470463	256	471750	260
433000	306	433932	302	464899	252	466848	242	468934	257	470487	267	471767	261
433017	306	433949	302	464943	257	466862	243	468941	257	470494	256	471774	261
433024	306	433956	302	464950	254	466886	243	468965	255	470500	297	471781	264
433031	306	433963	302	464967	239	466893	243	468972	296	470524	267	471798	264
433048	251	433970	302	464974	239	466916	242	468989	257	470548	301	471804	264
433246	283	433987	302	464981	239	466947	242	468996	253	470555	301	471811	264
433253	282	433994	302	464998	239	466961	242	469375	251	470562	299	471828	263
433277	282	434069	303	465001	239	466992	242	469382	253	470579	297	471835	263
433284	282	434755	278	465018	256	467005	242	469399	256	470586	302	471842	263
433291	282	434762	278	465421	299	467043	242	469405	240	470593	297	471866	260
433307	283	434779	278	465810	245	467074	246	469511	244	470609	297	471873	260
433314	282	434786	278	465827	245	467142	241	469856	286	470630	316	471903	265
433352	284	434793	278	465834	245	467173	241	469863	316	470654	245	471910	265
433376	282	434809	278	465841	245	467180	241	469870	254	470685	321	471927	265

Order no.	Page	Order no.	Page	Order no.	Page	Order no.	Page	Order no.	Page	Order no.	Page	Order no.	Page
471934	265	472948	261	473662	263	474287	252	475192	266	476762	320	478766	297
471941	265	472955	263	473709	251	474317	261	475253	266	476779	320	478773	299
471958	265	472962	263	473716	264	474324	261	475260	317	476793	334	478780	299
471965	265	472979	254	473723	264	474331	261	475277	317	476809	334	479008	297
471972	265	472986	263	473730	264	474348	261	475284	317	476816	334	479015	297
471989	321	472993	263	473747	264	474355	261	475291	317	476854	320	479022	298
471996	322	473013	260	473754	253	474362	257	475352	257	476861	320	479039	297
472009	266	473020	260	473761	264	474379	251	475376	334	476878	320	479046	298
472023	251	473037	260	473778	252	474409	257	475383	334	476908	335	479053	297
472030	251	473044	260	473785	264	474416	261	475390	334	476915	335	479060	298
472047	251	473051	260	473792	264	474423	261	475451	283	476953	322	479077	298
472054	251	473068	260	473808	257	474430	261	475468	283	476960	322	479107	297
472061	267	473075	255	473815	265	474447	261	475475	283	476977	322	479114	297
472078	263	473082	255	473822	265	474454	261	475482	283	476991	256	479121	298
472085	255	473099	255	473839	265	474461	261	475499	285	477004	297	479138	297
472092	252	473105	255	473846	265	474478	261	475574	334	477011	297	479145	298
472108	252	473112	260	473853	265	474485	257	475581	334	477028	297	479152	297
472115	252	473129	260	473860	265	474515	262	475598	297	477035	296	479169	298
472139	255	473211	262	473877	265	474522	262	475659	257	477042	296	479176	298
472146	255	473228	262	473884	265	474539	262	475666	257	477059	319	479206	297
472153	252	473235	262	473891	265	474546	262	475673	297	477066	319	479213	297
472160	252	473266	255	473907	255	474614	263	475680	334	477103	268	479220	298
472177	255	473297	278	473914	266	474621	263	475697	257	477110	268	479237	297
472184	251	473303	278	473921	255	474638	263	475765	257	477158	320	479244	298
472313	253	473310	261	473938	255	474645	263	475772	257	477165	320	479251	297
472320	253	473327	261	473945	252	474652	263	475789	257	477172	320	479268	298
472429	254	473334	261	473952	266	474669	263	475796	257	477257	320	479275	298
472436	254	473341	261	473969	255	474713	264	475895	334	477264	320	479305	297
472443	254	473358	261	473976	251	474720	264	475956	334	477271	320	479312	297
472450	254	473365	256	473983	256	474737	264	475963	334	477356	320	479329	298
472481	253	473372	255	473990	251	474744	264	475987	334	477363	320	479336	297
472498	253	473389	255	474003	256	474768	264	475994	334	477370	320	479343	298
472504	253	473419	261	474010	260	474782	264	476007	316	477455	322	479350	297
472511	254	473426	261	474027	260	474799	264	476014	316	477462	322	479367	298
472535	264	473433	261	474034	260	474812	265	476021	334	477479	322	479374	298
472573	253	473440	261	474041	260	474829	265	476038	334	477707	314	479381	296
472580	253	473457	261	474058	260	474836	265	476045	334	477714	314	479398	296
472597	253	473464	261	474065	260	474843	265	476076	334	477721	314	479404	296
472610	255	473471	261	474072	256	474850	265	476151	316	477738	314	479411	296
472627	255	473488	251	474089	251	474867	265	476205	317	477745	314	479428	296
472634	255	473501	251	474096	252	474874	265	476236	335	477752	314	479435	296
472641	255	473518	262	474102	251	474881	265	476243	335	477769	314	479503	318
472658	255	473525	262	474119	260	474898	265	476304	318	477776	314	479510	318
472665	255	473532	262	474126	260	474911	266	476311	318	477783	314	479527	318
472719	256	473549	262	474133	255	474935	255	476489	335	477790	314	479558	318
472726	256	473556	263	474140	255	474942	255	476496	335	478650	316	479602	317
472733	256	473563	263	474157	254	474959	266	476526	335	478667	316	479619	317
472764	256	473570	263	474164	255	474966	255	476557	319	478674	316	479626	317
472801	254	473587	263	474171	255	474973	255	476564	319	478681	316	479657	316
472818	257	473594	263	474188	256	474997	255	476571	319	478698	299	479664	316
472825	257	473600	263	474195	255	475086	256	476656	320	478704	299	479671	316
472856	254	473617	263	474201	251	475093	256	476663	320	478711	299	479701	317
472863	254	473624	263	474218	262	475154	267	476670	320	478728	299	479718	317
472917	260	473631	263	474249	255	475161	267	476694	268	478735	299	479725	317
472924	260	473648	263	474256	255	475178	267	476700	268	478742	299	479756	317
472931	261	473655	263	474270	255	475185	267	476755	320	478759	297	479763	317

Order no.	Page	Order no.	Page	Order no.	Page	Order no.	Page	Order no.	Page	Order no.	Page	Order no.	Page
479848	251	484088	319	485092	297	487102	332	488482	271	489090	274	490799	329
479855	251	484095	319	485108	297	487126	332	488499	271	489106	274	490805	329
479879	253	484101	319	485115	300	487133	332	488505	271	489113	274	490812	329
479886	254	484118	319	485122	300	487164	332	488512	271	489120	274	491376	326
479893	254	484125	319	485139	300	487188	332	488529	271	489137	274	491383	326
479909	254	484132	318	485146	300	487195	332	488536	271	489144	274	491390	326
479916	254	484149	318	485153	301	487201	332	488543	271	489151	274	491475	327
479923	257	484156	318	485160	301	487225	332	488550	271	489168	275	491482	327
479930	257	484163	318	485177	301	487249	332	488567	271	489175	275	491499	327
479947	257	484170	318	485184	301	487263	290	488574	271	489205	275	491505	327
479954	252	484187	318	485207	301	487270	290	488581	271	489229	275	491512	327
479961	252	484200	314	485214	301	487287	290	488598	271	489236	275	491925	326
479978	263	484217	314	485221	301	487294	290	488604	271	489243	275	492175	256
479985	263	484224	314	485238	301	487300	290	488611	271	489250	276	492182	256
479992	263	484248	314	485245	307	487331	291	488628	271	489304	263	492199	257
480011	263	484262	314	485252	307	487348	291	488635	271	489311	264	492205	296
480028	263	484484	318	485269	301	487355	291	488642	271	489328	263	492212	253
480035	263	484491	318	485276	301	487362	291	488659	271	489335	263	492229	251
480042	263	484507	299	485306	291	487379	291	488666	272	489342	263	492434	253
480066	264	484514	299	485313	291	487409	291	488673	272	489359	264	492441	252
480073	264	484521	299	485337	290	487416	291	488680	272	489366	260	492458	251
480080	264	484538	299	485344	290	487423	291	488727	272	489373	260	492465	257
480097	264	484545	299	485351	290	487430	291	488734	272	489380	260	492472	296
480165	260	484552	299	485368	290	487447	291	488741	272	489397	260	492489	297
480172	263	484569	299	485382	290	487454	291	488758	272	489977	297	492496	256
480189	264	484576	299	485399	290	487461	291	488765	273	489991	299	492502	256
480196	260	484583	299	485405	290	487881	256	488772	273	490010	326	492519	257
480264	262	484590	299	485429	291	487898	298	488789	273	490027	326	492526	296
480271	260	484606	299	485436	291	488093	298	488796	273	490034	326	492533	296
480288	260	484668	298	485443	291	488109	255	488802	273	490096	326	492540	252
480295	265	484675	298	485450	291	488116	254	488819	273	490102	326	492557	296
480462	264	484682	300	485467	291	488130	257	488826	273	490119	326	492564	254
480479	262	484699	300	485474	291	488147	252	488833	273	490133	325	492571	297
480486	265	484705	300	485481	291	488154	257	488840	273	490140	325	492588	299
480585	261	484729	300	485498	291	488161	253	488857	273	490157	325	492595	251
480639	262	484736	300	485504	290	488178	251	488864	273	490300	325	492601	251
480646	262	484859	300	485511	290	488185	251	488871	273	490317	325	492618	268
480653	261	484866	300	485542	290	488192	253	488888	273	490324	325	492625	268
480660	261	484873	300	485559	290	488208	296	488895	273	490447	325	492632	268
480677	264	484880	300	485566	290	488215	299	488925	273	490454	325	492649	268
480684	260	484897	300	485573	290	488222	256	488932	273	490478	325	492700	331
480691	265	484910	296	485580	290	488284	263	488949	274	490485	327	492717	331
480820	260	484927	296	485597	290	488291	263	488956	274	490492	327	492731	331
480837	265	484934	296	485603	265	488307	270	488963	274	490508	327	492823	331
480844	265	484941	296	485610	265	488314	270	488970	274	490522	327	492830	331
482756	334	484958	296	485627	266	488321	270	488987	274	490539	327	492854	331
482763	334	484965	296	485634	266	488338	270	488994	274	490546	327	492946	331
482770	334	484972	296	485641	265	488345	270	489007	274	490560	327	492953	331
482886	320	484989	296	485658	265	488352	270	489014	274	490577	327	492977	331
484002	321	484996	296	485672	266	488369	270	489021	274	490584	327	499785	252
484019	321	485030	297	485818	297	488376	270	489038	274	490607	327	499808	256
484026	321	485047	297	485832	297	488383	270	489045	274	490621	327	499815	297
484040	321	485054	297	485856	298	488390	270	489052	274	490638	327	499822	256
484057	321	485061	297	487041	332	488420	270	489069	274	490720	329	499839	298
484064	321	485078	297	487065	332	488437	270	489076	274	490737	329	499853	298
484071	319	485085	297	487072	332	488451	270	489083	274	490744	329	499860	254

Order no.	Page	Order no.	Page	Order no.	Page	Order no.	Page	Order no.	Page
499877	252	564452	221	565015	222	802196	337	903855	113
553548	223	564469	221	610630	164	802202	341	903862	114
553555	223	564476	221	610647	164	802219	341&349	903879	113
553586	226	564483	221	635190	236	802226	339	903886	114
553593	226	564490	221	639006	236	802240	340		
553609	226	564506	221	639105	236	802257	340		
553616	226	564513	221	639648	237	802264	340		
553623	226	564520	221	639662	237	802271	340		
553630	226	564537	222	639679	237	802288	340		
553647	226	564544	222	642198	236	802295	340		
553654	226	564551	222	654047	193	802301	340		
553661	226	564568	222	692216	351	802318	350		
553678	226	564575	222	692254	351	802387	344		
553685	226	564582	222	692391	350	802615	344		
553692	226	564599	222	692483	351	802622	341		
553708	226	564605	222	692506	351	802707	344		
554293	194	564612	219	700218	206	803001	347		
554309	194	564629	219	700225	206	803025	347		
554361	224	564636	219	700232	206	803056	347		
554378	224	564643	219	700256	207	803070	347		
554385	224	564650	219	700300	207	804022	347		
554415	224	564667	219	701505	207	804039	347		
554880	193	564674	219	701512	208	804046	347		
557171	227	564681	219	701536	208	804053	347		
557751	225	564698	219	701901	208	804060	347		
557768	225	564704	219	701956	207	804077	347		
557775	225	564711	219	702472	205	804091	347		
557782	225	564728	219	702489	205	805500	345		
558802	223	564735	220	702496	205	805517	345		
558819	223	564742	220	725051	78	805524	345		
558826	223	564759	220	725068	78	805531	345		
564209	219	564766	220	725075	78	805548	345		
564216	219	564773	220	800703	347	805555	345		
564223	219	564780	220	800710	347	805562	345		
564230	219	564797	220	800802	347	805579	345		
564247	219	564803	220	800819	347	805593	346		
564254	219	564810	220	801960	343	805609	346		
564261	219	564827	220	801977	342	805623	343		
564278	219	564834	220	801984	343	805647	343		
564285	219	564841	220	801991	342&349	805654	343		
564292	219	564858	221	802011	342&349	870119	139		
564308	219	564865	221	802028	337	901554	115		
564315	219	564872	221	802042	337	901622	228		
564322	220	564889	221	802059	337	901646	228		
564339	220	564896	221	802066	338	901851	39		
564346	220	564902	221	802073	337	901868	39		
564353	220	564919	221	802080	337	901905	38		
564360	220	564926	221	802097	338	901912	38		
564377	220	564933	221	802103	338	901929	38		
564384	220	564940	222	802110	340	901936	38		
564391	220	564957	222	802127	339	903664	39&180		
564407	220	564964	222	802134	339	903800	114		
564414	220	564971	222	802141	339	903817	114		
564421	220	564988	222	802158	337	903824	114		
564438	220	564995	222	802165	337	903848	113		
564445	221	565008	222	802189	337	903855	113		

ALBERTS®

Gust. Alberts GmbH & Co. KG
Blumenthal 2 · 58849 Herscheid · Phone +49 (0) 2357 907-0
alberts.de/en

400606EN · 03/2023